



## Installation Guide

**TVS 1320 supercharger**

**Toyota GR86/Subaru BRZ 2021-present**



ENGINEERING PERFORMANCE SINCE 1955

For over 65 years Harrop Engineering has been at the forefront of designing, developing and manufacturing precision performance components. Today our innovative and logical approach is applied to low volume automotive OEMs and the performance aftermarket through a dedicated team of 65 staff. Core performance products include Superchargers, Engine Components, Brakes, Differentials and we are also the exclusive Australian Distributor for Forgeline Motorsport Wheels.

Harrop are also the preferred supplier of Eaton Supercharger and Traction Control technology including dual branded product designed and manufactured in-house. There are currently over 4,000 components in our portfolio and this is growing daily as we continually develop more Harrop Performance Products.

Our high profile car manufacturing customers have included Holden, HSV, FPV, Ford, Roush, Toyota, TRD and Lotus.

We also supply to race teams from categories including F1, NASCAR and V8 Supercars and an extensive range of drag, circuit and off-road competitors. Just as importantly, a large portion of our customers are performance enthusiasts and weekend warriors who are highly passionate about their ride.

Please take a moment to review the following pages and learn why Harrop is the first choice in Superchargers.

Thank you for choosing Harrop and enjoy your Harrop Enhanced ride.

- Team **HARROP**

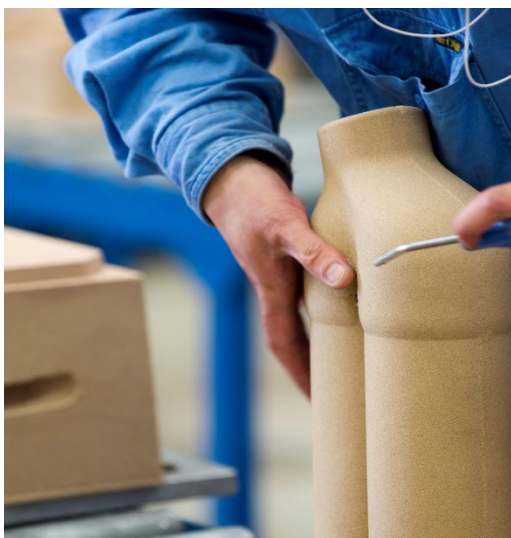

## Table of Contents

<b>Important Information</b> .....	4
<b>1) Vehicle preparation</b> .....	5
<b>2) Remove ancillaries</b> .....	5
<b>3) Remove intake manifold</b> .....	5
<b>4) Supercharger pre installation</b> .....	8
<b>5) Supercharger installation</b> .....	12
<b>6) Rear A/C line clearance</b> .....	16
<b>7) Throttle body installation</b> .....	16
<b>8) Idler and belt installation</b> .....	17
<b>9) Air box installation</b> .....	18
<b>10) Intercooler system installation</b> .....	19
<b>11) Intercooler pump wiring</b> .....	24
<b>12) Intercooling system filling and bleeding</b> .....	28
<b>13) Pre startup checks</b> .....	28
<b>14) Start engine</b> .....	29
<b>15) Road test</b> .....	29

### Important Information

Installing the supercharger indicates your acceptance of the responsibility and liability associated with the fitment and use of this product. Please ensure the owner and drivers of the supercharged vehicle are aware of their responsibilities and liabilities as indicated below. Thank you for purchasing this supercharger which has been designed and made with pride. The owner and drivers of the enhanced vehicle must be aware that fitment of a supercharger may affect:

- The vehicle's factory warranty.
- Insurance cover and associated liabilities.
- Compatibility with emission and roadworthy certification.
- The validity of a driver's license for a supercharged vehicle.
- The handling & braking capability of the vehicle due to increased engine power & torque characteristics.
- The longevity of the engine.
- The vehicle will need to use premium unleaded fuel only (98 RON).

It is the owner's/driver's responsibility to accept any consequences and liabilities of using the supercharger and any subsequent effect it may have. Harrop Engineering shall not be liable and shall be 'Held Harmless' for any direct and/or indirect/consequential losses, costs, damages, expenses, injuries or liabilities whatsoever incurred by the owner/driver of the vehicle or other parties arising from this supercharger, its installation and/or its operation. It is recommended that vehicles have completed 1,500 km and have been driven, serviced and maintained in accordance with the vehicle manufacturer's handbook before fitting a supercharger. An engine should be deemed reliable and have delivered all reasonable expectations in line with the vehicle manufacturer's specifications prior to fitting a supercharger.

### Warranty.

This supercharger is covered by a limited warranty on components and workmanship for a period of 36 months from the date of purchase, subject to the following:

- Installation must be completed by a qualified motor mechanic or technician who has undertaken appropriate training in fitting Harrop superchargers.
- The supercharger has not been modified or "overdriven" by fitting alternative drive pulleys.
- The supercharged vehicle has been tuned by an appropriately qualified and experienced technician.
- The supercharged vehicle has been driven in accordance with the conditions specified by the vehicle manufacturer's normal use of operation, driving care and vehicle service program.
- The supercharged vehicle has not been used for competitive racing.

No warranty shall apply where Harrop have determined improper fitment or handling, misuse in operation, neglect, or accident damage. Engine modifications made prior to or in conjunction with the supercharger fitment may invalidate the Harrop limited warranty. Any warranty claims must be made immediately & directly in writing to Harrop Engineering so that a determination can be made promptly. Involvement of a third party or an attempt to repair a perceived/actual fault may invalidate the warranty. To the extent of the law, the determination on any warranty claim & associated costs will be at the sole discretion of Harrop Engineering.

By installing the supercharger you acknowledge that all conditions pertaining to this supercharger and its operation have been read, understood and accepted.

References to left and right are made to the vehicles side and NOT the installer

### 1) Vehicle preparation

- a) Ensure the vehicle is prepared with 98 RON unleaded fuel.
- b) Disconnect battery.
- c) Ensure the engine and surrounding areas are cool.

### 2) Remove ancillaries

- a) Remove inlet tube between air box and throttle body.
- b) Remove entire air box.
- c) Remove MAF sensor from the air box.
- d) Remove covers from alternator and A/C compressor.
- e) Use 14mm socket and breaker bar on tensioner and remove belt.
- f) Remove the strut braces.

### 3) Remove intake manifold

- a) Remove cover from the top of the manifold.
- b) Unclip the 6 clips holding the battery cables to the intake manifold.
- c) Disconnect vacuum hoses from the rear of the intake manifold.
- d) Disconnect MAP sensor and throttle body wiring harnesses.
- e) Remove fuel rail covers and unbolt the ECU from the RH cover (this will sit beside the engine while you work).
- f) Remove port injector harnesses x4 and unclip harness from fuel rail assembly.
- g) Remove EVAP solenoid harness from the rear of the intake manifold.
- h) Remove throttle body heater hoses.





- i) Remove throttle body from inlet manifold.
- j) Disconnect the fuel lines (CAUTION – use eye protection when disconnecting fuel system lines as they will contain fuel and may have some residual fuel pressure. Do not disconnect the fuel supply line immediately after running the vehicle or when the vehicle is hot).

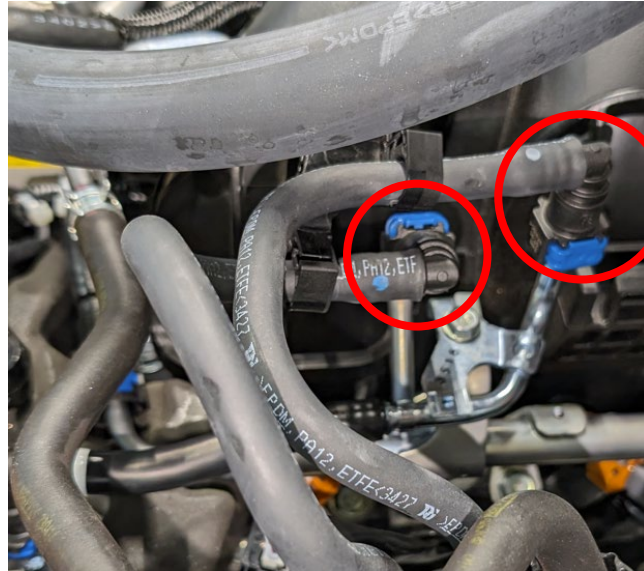

- k) Disconnect the fuel crossover pipe from both fuel rails.



- l) Remove the EVAP purge hose from the fuel rail fitting.

- m) Remove the 6 intake manifold bolts and remove the intake manifold (picture of manifold from the underside shown for clarity of bolt locations). Note engine harnesses on RH rear and LH front need to be pushed aside to access bolt heads.



- n) Unclip loom from LH rear lug on manifold.



- o) Cover intake ports with tape while working on and around the engine bay.  
p) Remove EVAP solenoid from the underside of the intake manifold.  
q) Remove the MAP sensor from the manifold.

#### 4) Supercharger pre installation

- a) Remove the throttle body heater hoses and install the included throttle body heater blanking plugs.



- b) Install EVAP solenoid to supercharger manifold using the original bolt and the supplied M6 flanged nut.
- c) Plumb EVAP solenoid using the original lines and 13mm Cobra clamp as shown.
- d) Fit the supplied cap and 14mm cobra clamp as shown.
- e) Trim the original PCV hose to the white line as shown.

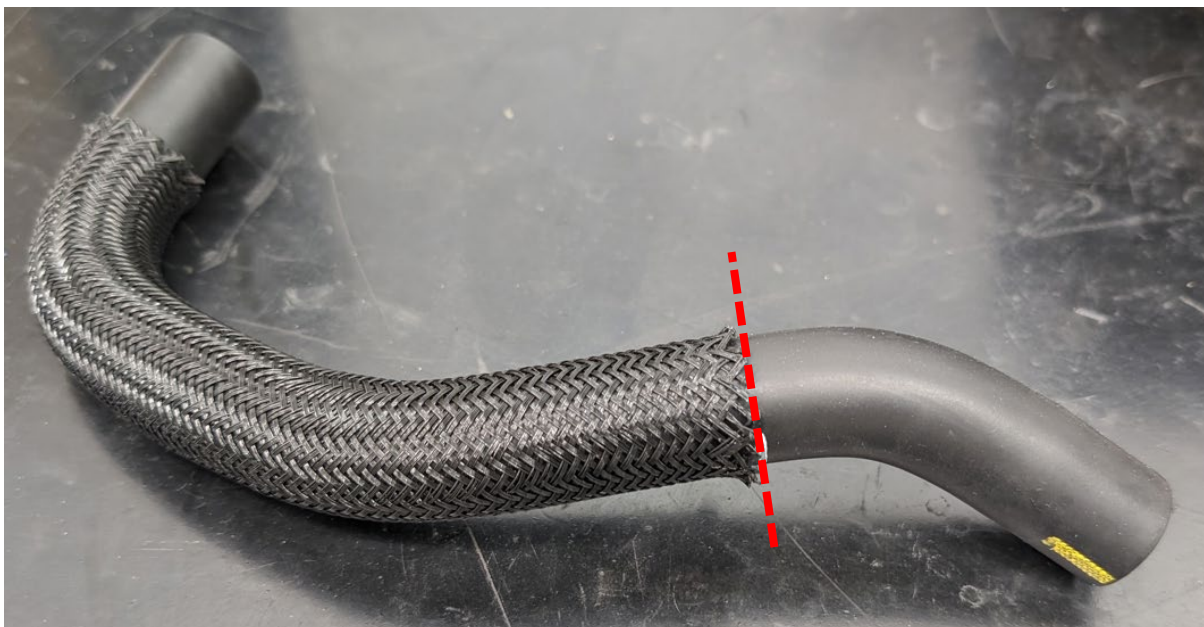



- f) Insert the supplied PCV extension to the original PCV hose and install on supercharger as shown using 16mm cobra clamp.

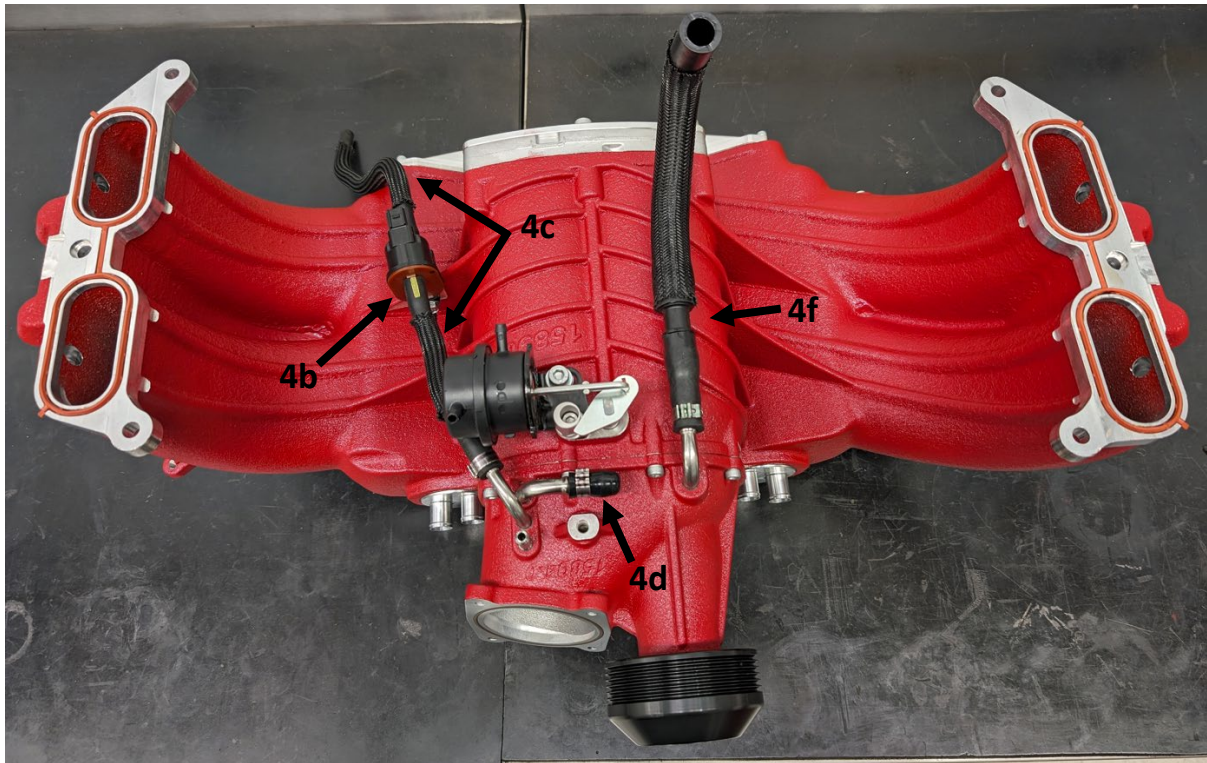

- g) Install engine breather line (under A/C compressor) as shown.

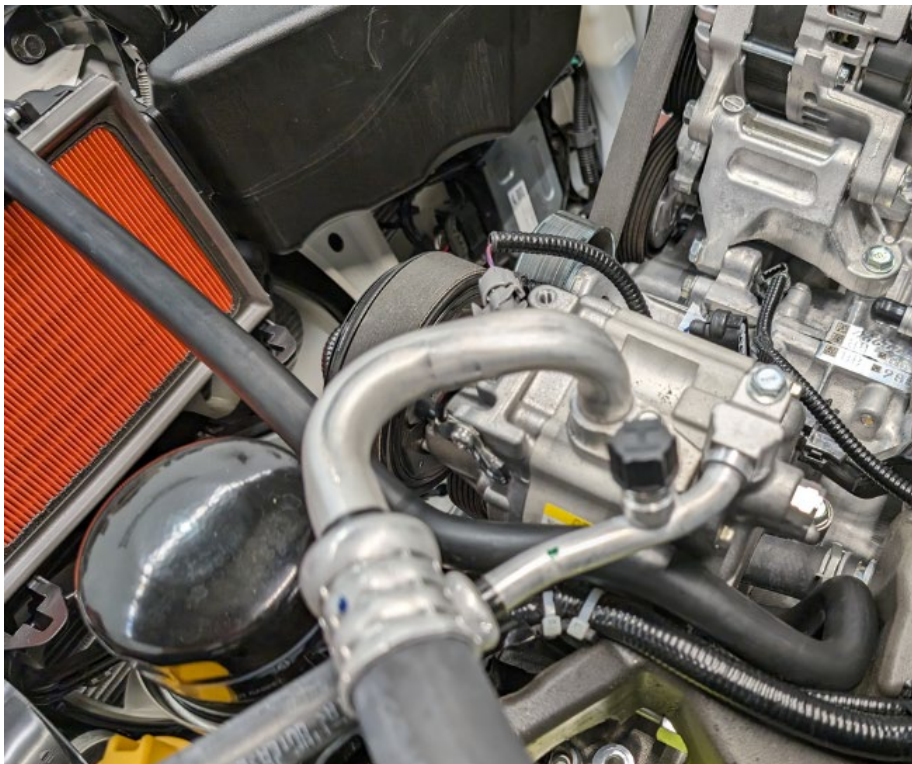

- h) Move the battery cable loom and zip tie it back out of the way.

- i) Cut off the end of the hard plastic cover (located on the rear RHS of the A/C compressor) that covers the engine loom as shown.



- j) Install supplied throttle, MAP, MAF loom and route as shown (connect the supplied loom to the standard connectors and zip tie IAT loom to breather hose behind A/C compressor).





- k) Remove the fuel rail bolts x4, fuel rails, fuel injectors and seals (be sure the injector seals are removed from the standard manifold as they sometime stick in the manifold when removing the injector, its easiest if these seals are removed from the injectors and installed into the SC manifold for assembly) from the standard manifold and reinstall on the supercharger manifold (fuel rail bolt torque 19 Nm) Note injector keying.

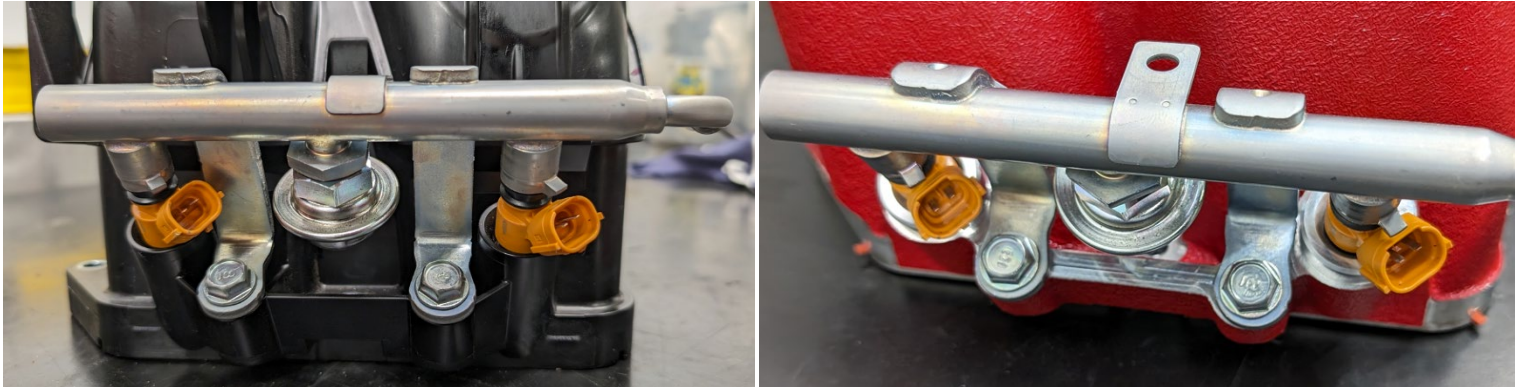

- l) Install the original MAP sensor into the supercharger manifold and secure using the provided M5 button head screw.



- m) Remove standard manifold rubber gaskets from standard manifold and install into supercharger manifold (ensure manifold faces are clean and avoid sliding the supercharger assembly on the seals after installation as this will damage the seals).

## 5) Supercharger installation

- a) Ensure that the engine looms and hoses are clear from the intake ports / manifold face and the front centre section of the engine. (Note: ensure main cross over loom is sitting flat as height between SC and loom is limited).
- b) Place the fuel crossover pipe in position as shown.

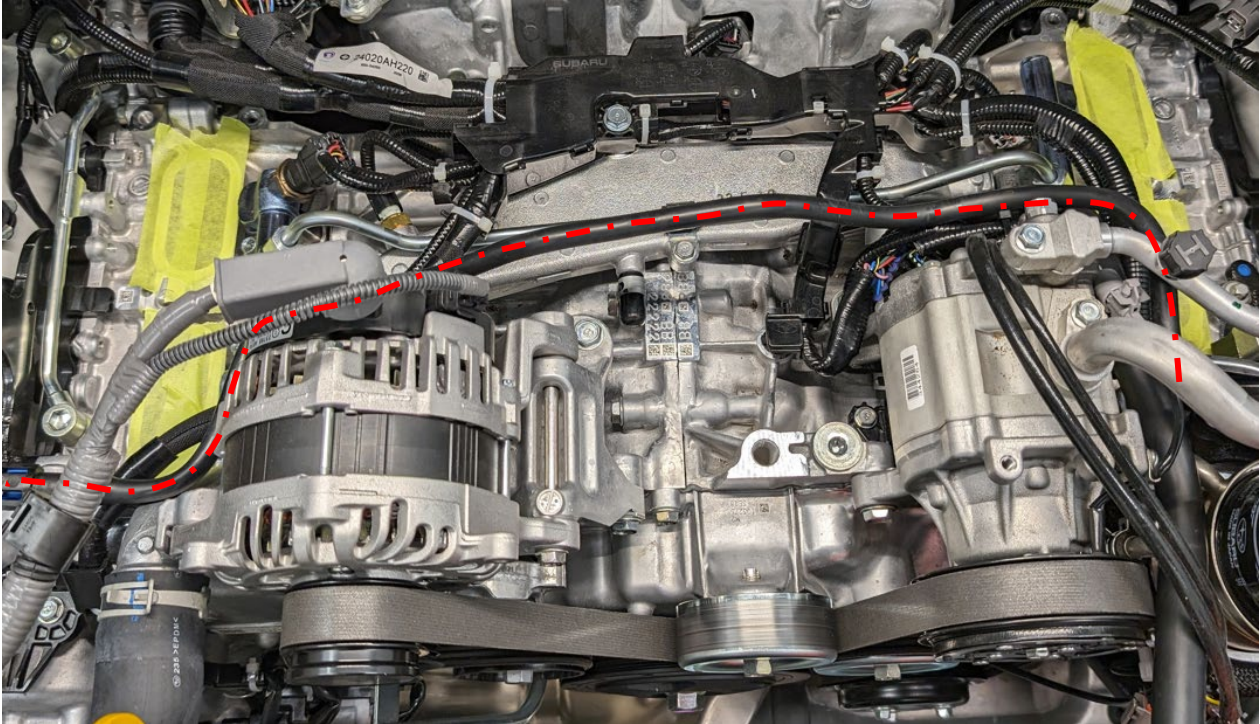

- c) Remove tape from the inlet engine ports. Inspect Supercharger manifold assembly including the ports to ensure there is no foreign objects or debris.
- d) Install the supplied M8x30 manifold socket head cap screws through the supercharger manifold into the cylinder heads.



- e) Torque the manifold bolts to 10 Nm in the sequence shown and then 20 Nm in the sequence shown below.

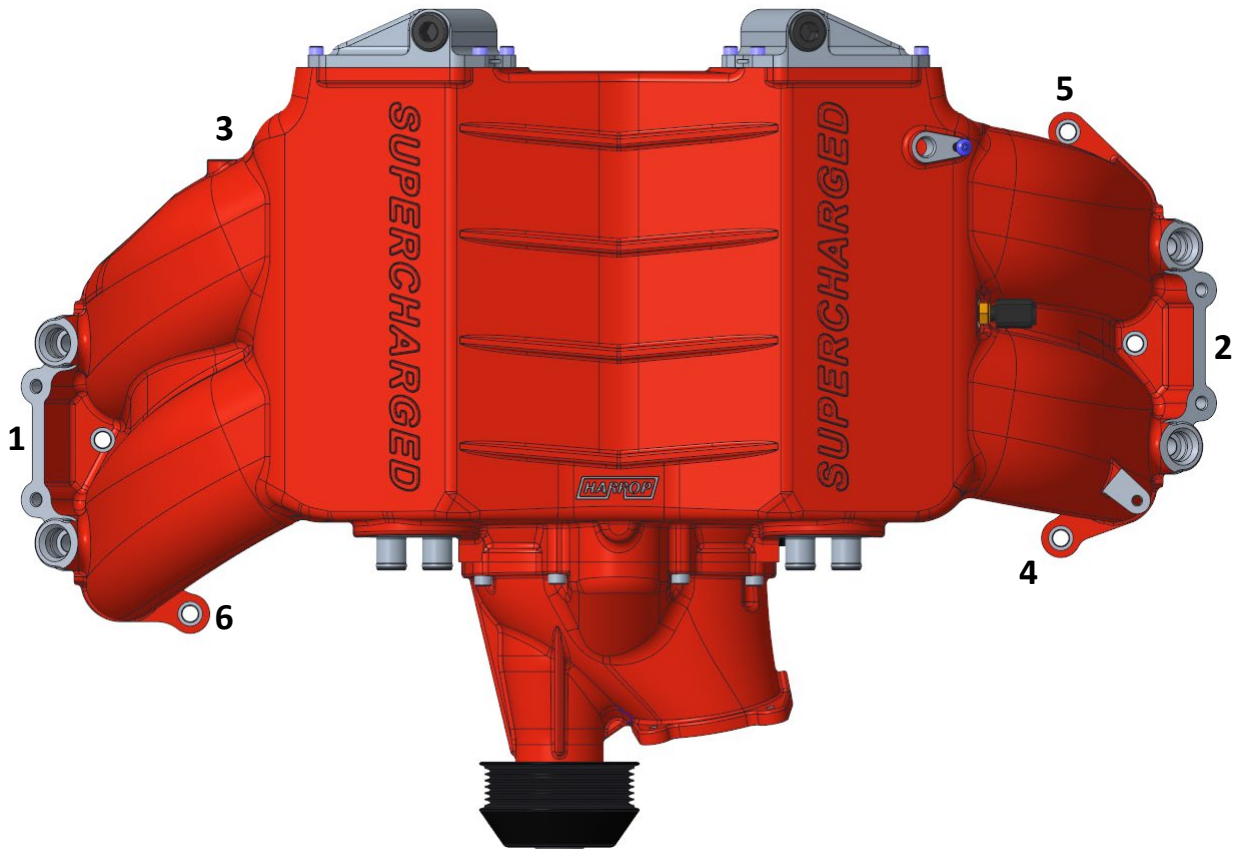

- f) Connect the fuel crossover pipe to the fuel rail fittings on both fuel rails (ensure the fittings are straight when being connected as to not damage the internal O-rings in the fittings and the clips are fully engaged).

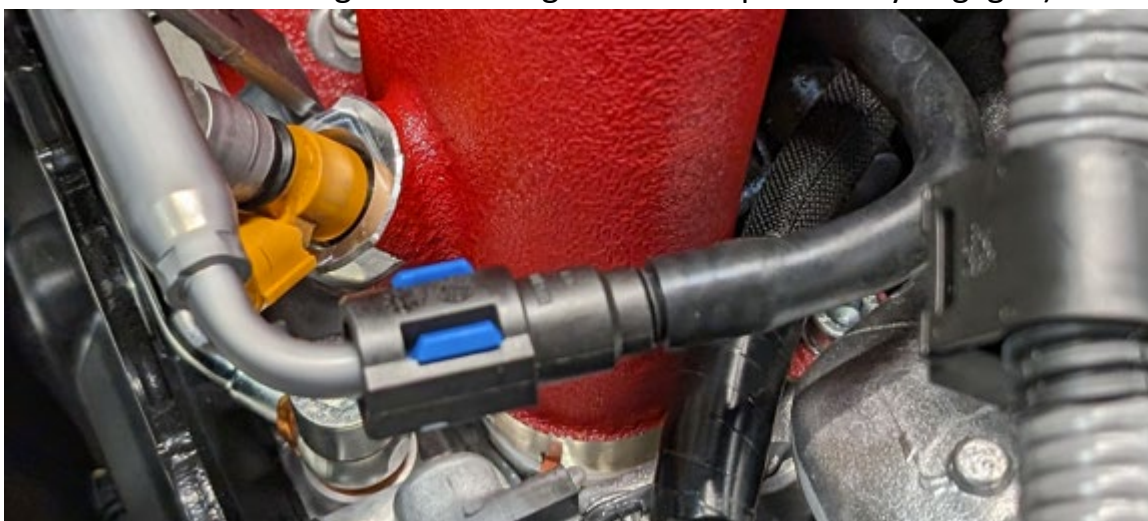

- g) Connect the PCV vacuum line to the port on the engine block as shown and fasten with hose clamp (under the rear RH of the supercharger).

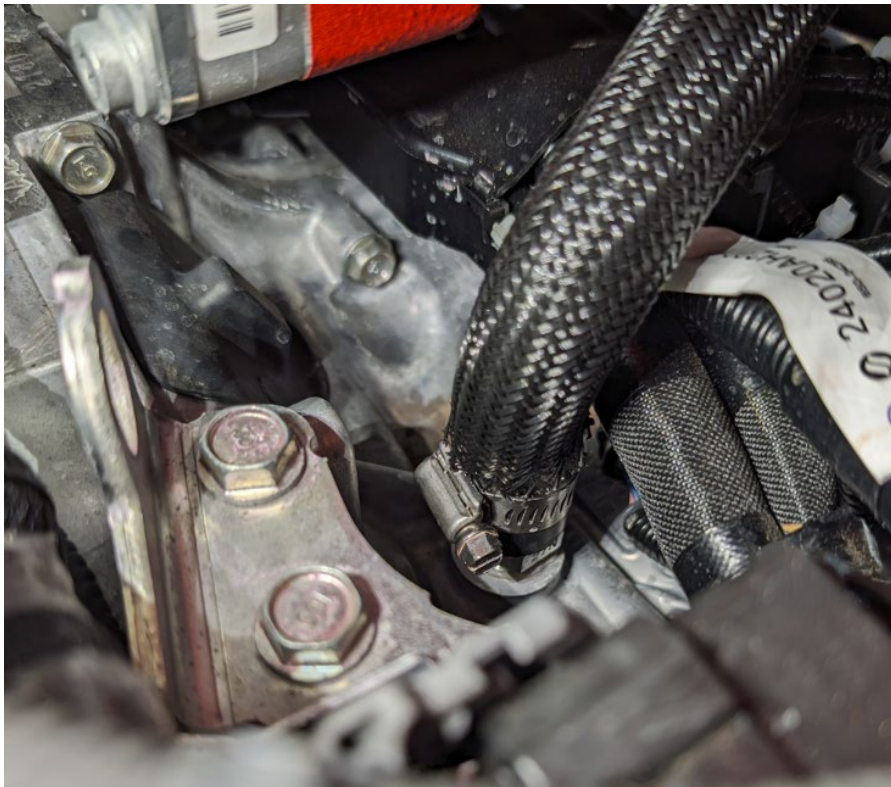

- h) Connect the fuel injector plugs.  
i) Connect EVAP solenoid wiring.  
j) Connect the MAP and IAT connectors to the sensors and run loom as per image below.

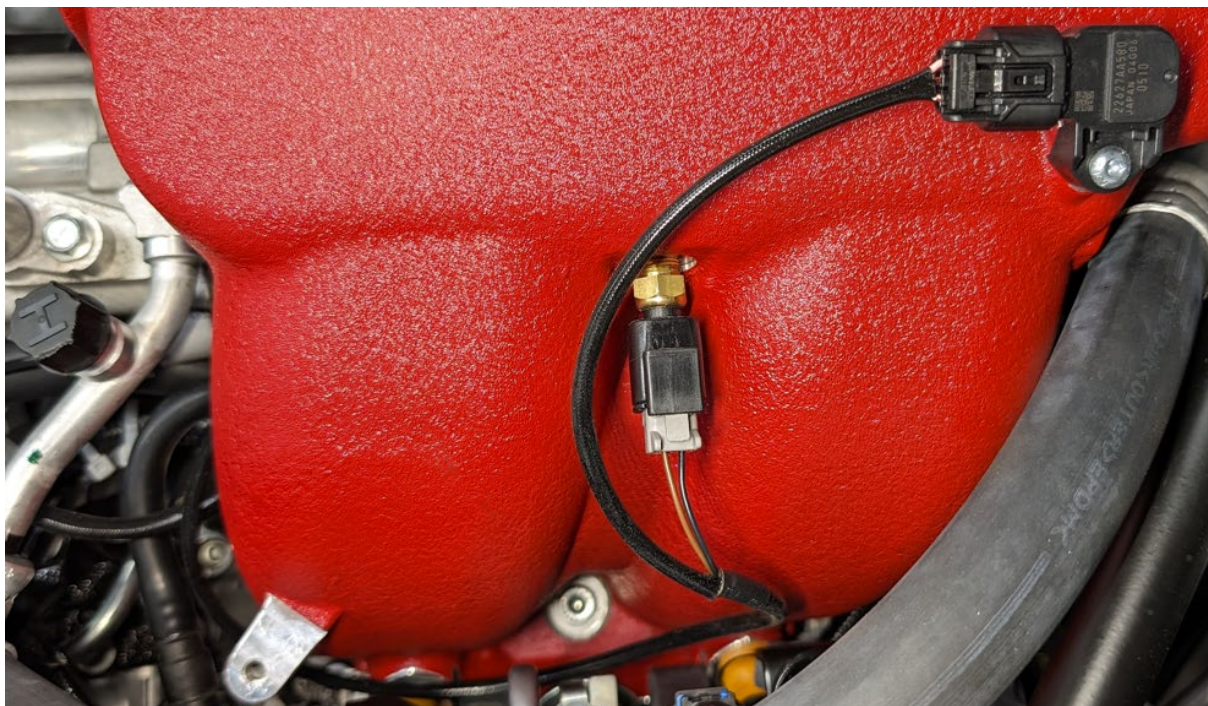



- k) Re install the fuel rail covers and the ECU on the RH cover. When installing the LHS fuel rail cover, use the rear bolt to also bolt down the fuel purge line as shown. Note that fuel purge line bracket hole needs to be drilled out to 8.5mm.



- l) Connect the low and high pressure fuel supply lines (ensure the fittings are straight when being connected as to not damage the internal O-rings in the fittings and the clips are fully engaged).
- m) Re install strut braces.

## 6) Rear A/C line clearance

- a) The rear A/C line will most likely be touching the manifold.
- b) Using the supplied bending tools the lower aluminium section of the line near the firewall can be bent to the correct angle for clearance to both the manifold and strut brace.
- c) Position the tool on the line as shown (ensure the tool does not contact the A/C fitting).



- d) Using a G clamp or similar, clamp the tool bending the line to the correct angle.

## 7) Throttle body installation

- a) Remove 2 heater fittings from the throttle body.





- b) Check that the SC manifold has an 'O' ring installed for the standard throttle body.
- c) Install the throttle body to the supercharger manifold as shown using the standard bolts torque to 10Nm.

### 8) Idler and belt installation

- a) Remove the bolt from the alternator as per image below and install the spacer, idler pulley, washer, and new bolt as shown (torque to 25Nm).

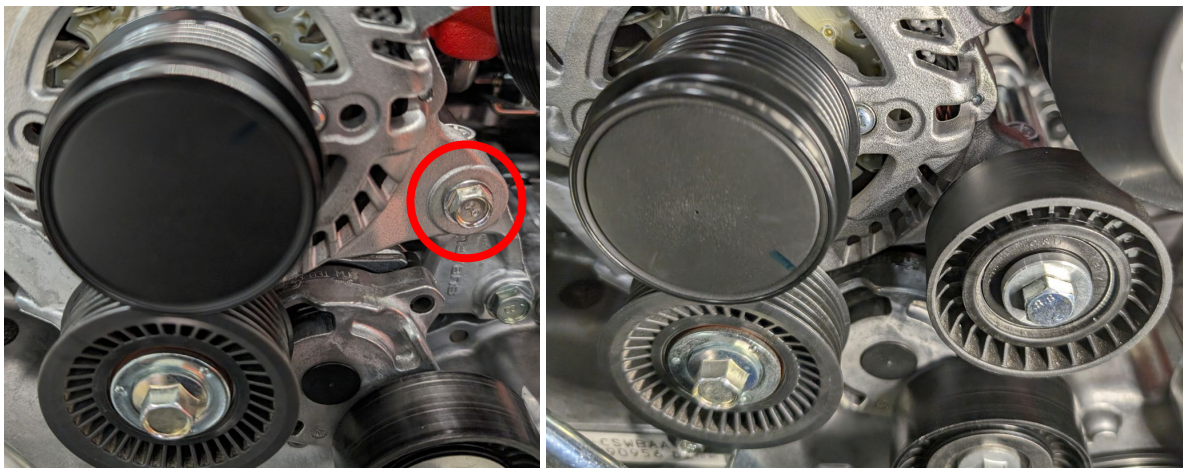

- b) Using a 14mm socket and breaker bar on the belt tensioner install the supplied belt in the route as shown.

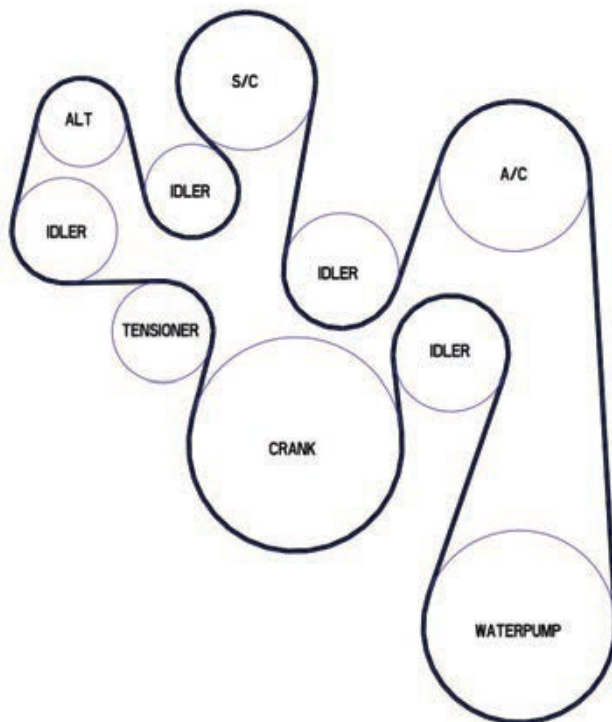

## 9) Air box installation

- a) Install MAF sensor to the supplied air box as shown.



- b) Reinstall the dirty side air box.  
c) Install the supplied clean air side air box and clip into position.  
d) Install the rubber boot.  
e) Install hose clamps.  
f) Connect the PCV breather line to the air box fitting as shown (line may need to be trimmed to length).  
g) Connect the throttle/MAF extension loom and secure with cable ties.

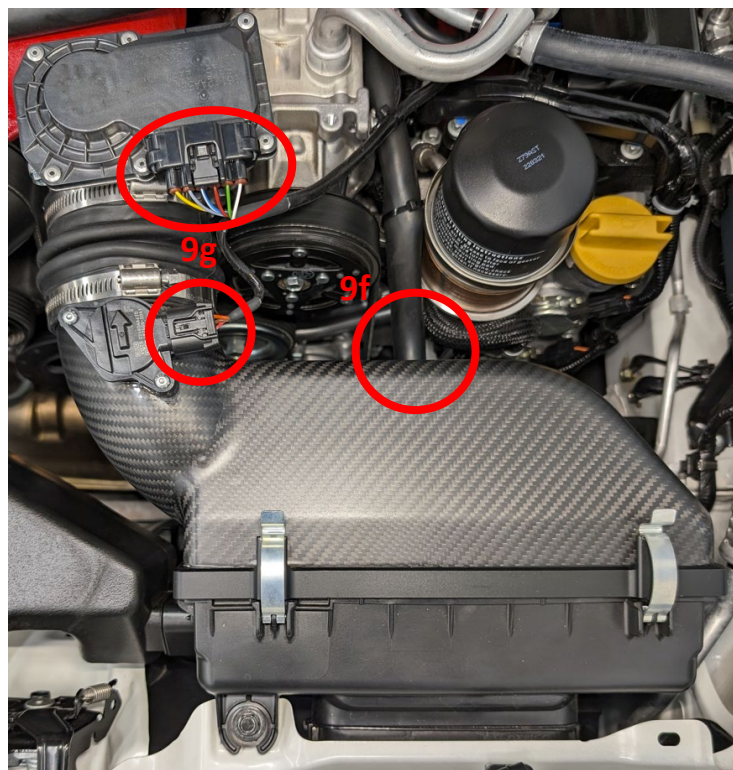

## 10) Intercooler system installation

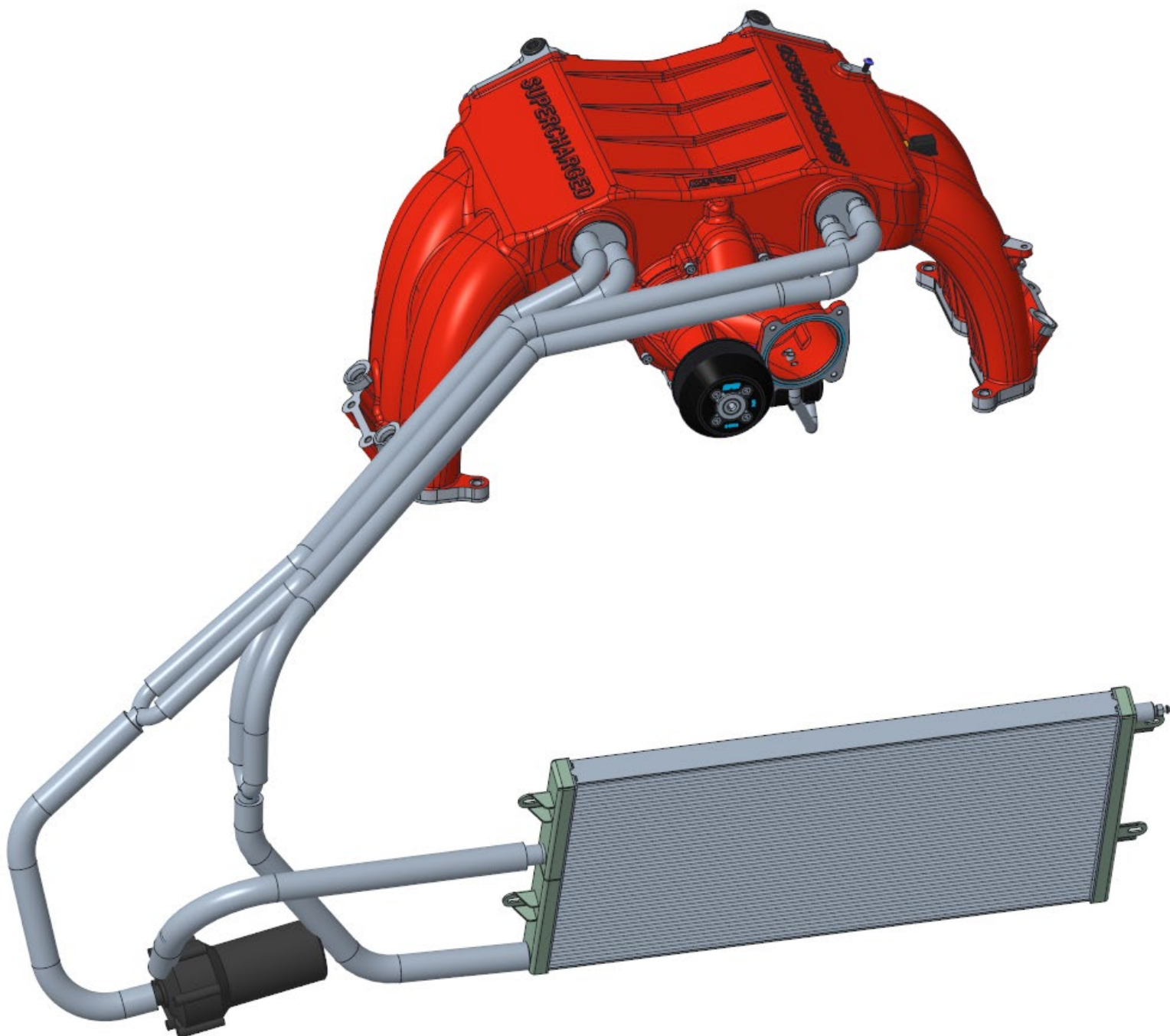



- a) Working from the engine bay connect 4 intercooler lines (2 sets, each hose is a different moulding) to the manifold using the 25mm cobra clamps and route the lines from the manifold down to the cavity behind the RH headlight. Install the 2 hose separator's in the positions shown below (separator closest to the fuse box has a clip over the alternator loom).

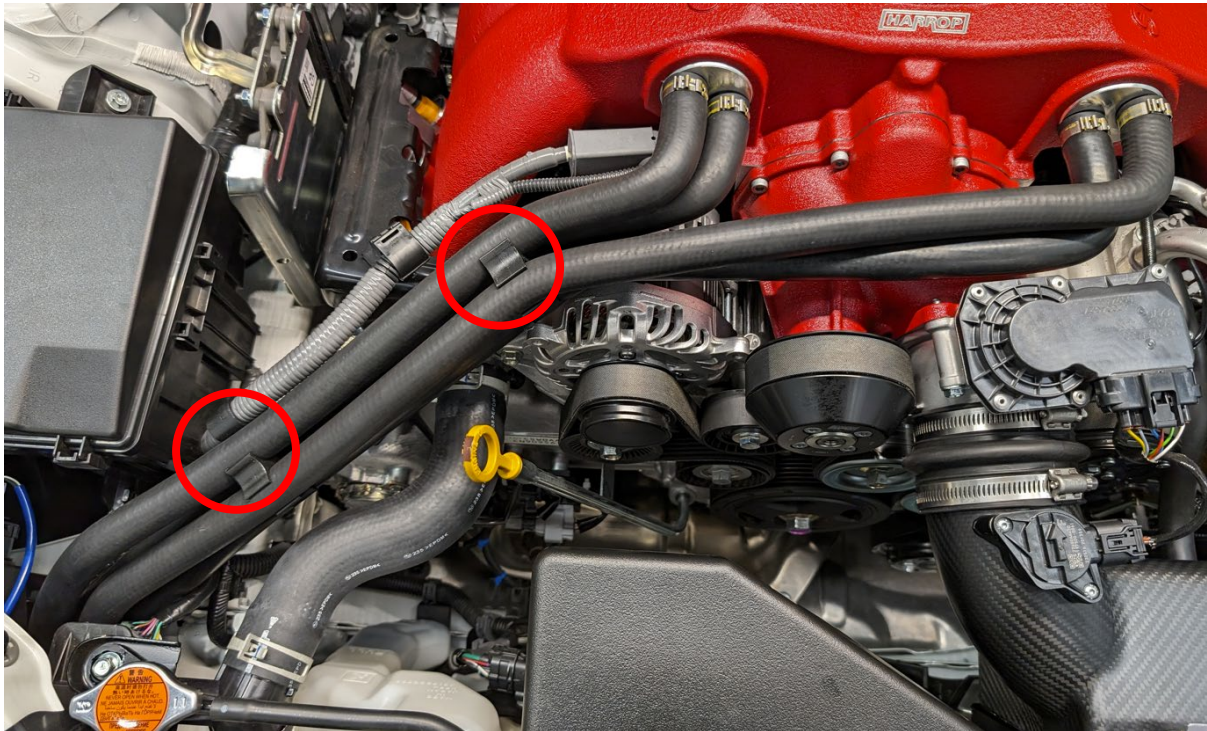

- b) Working from under the vehicle remove the 2 plastic under trays.  
c) Remove the RH plastic side cover and cut a hole using the image below to allow for the intercooler hose to run through it and re install.

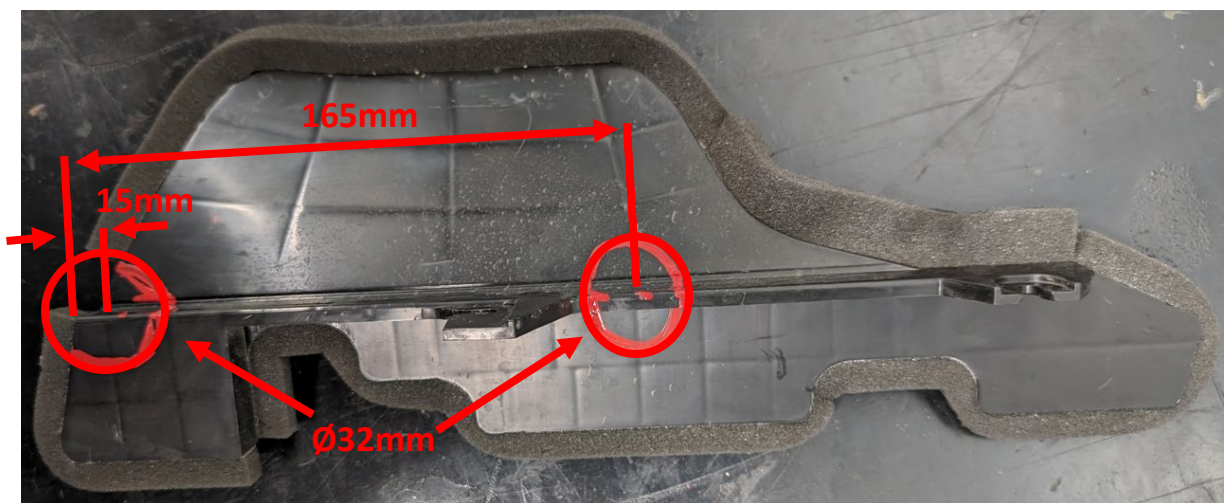



- d) Unclip the ambient air temp sensor from the lower RHS A/C condenser bracket.
- e) Clip the ambient air temp sensor into the horn bracket as shown.



- f) Remove lower RHS A/C condenser bracket.
- g) Cut off areas marked in red from the lower RHS A/C condenser bracket and paint cut surfaces.

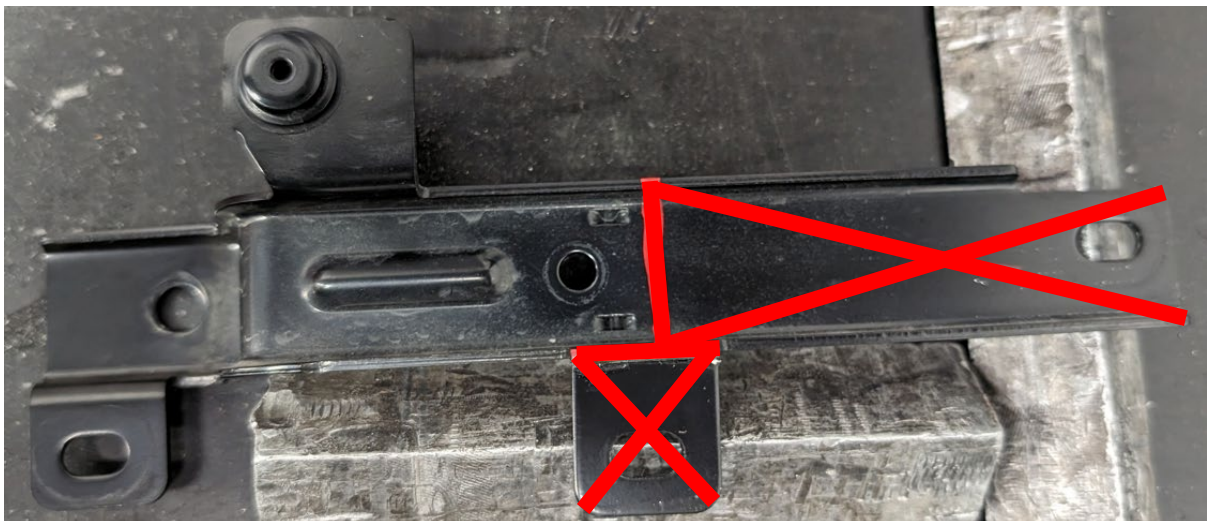

- h) Remove the 3 remaining mounting bolts for the A/C condenser.
- i) Reinstall the lower RHS A/C condenser bracket.
- j) Install the intercooler heat exchanger as shown and re install the 4 mounting bolts.

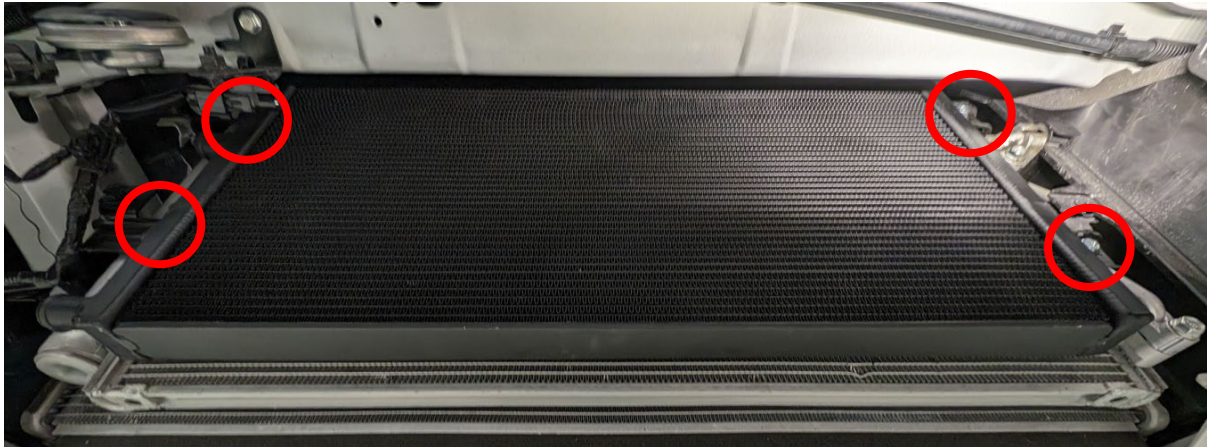

k) Assemble the foam onto the pump, the first strip is placed about 3mm from the pump motor edge and the second about 60mm.

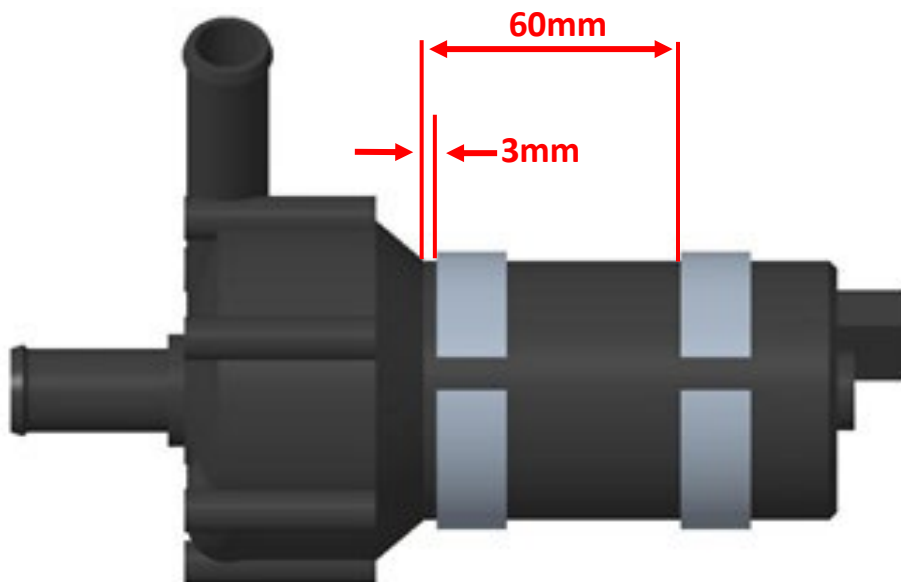

l) Assemble bracket to pump using the hose clamps supplied. Ensure the angle is about 45° to bracket mounting face.

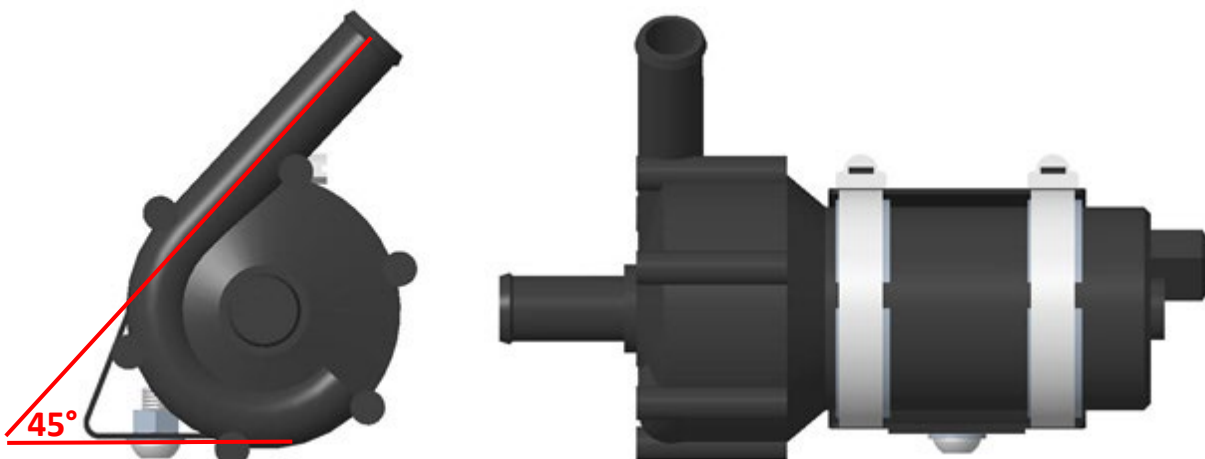

m) Install the pump assembly as shown using the M8 bolt / washer.



n) Connect the pump outlet A from the pump to the top fitting in the heat exchanger, connect the line from the engine bay (closest to the rail) to the lower fitting on heat exchanger, connect the remaining line from the engine bay to the pump inlet B using the 18-32mm hose clamps.

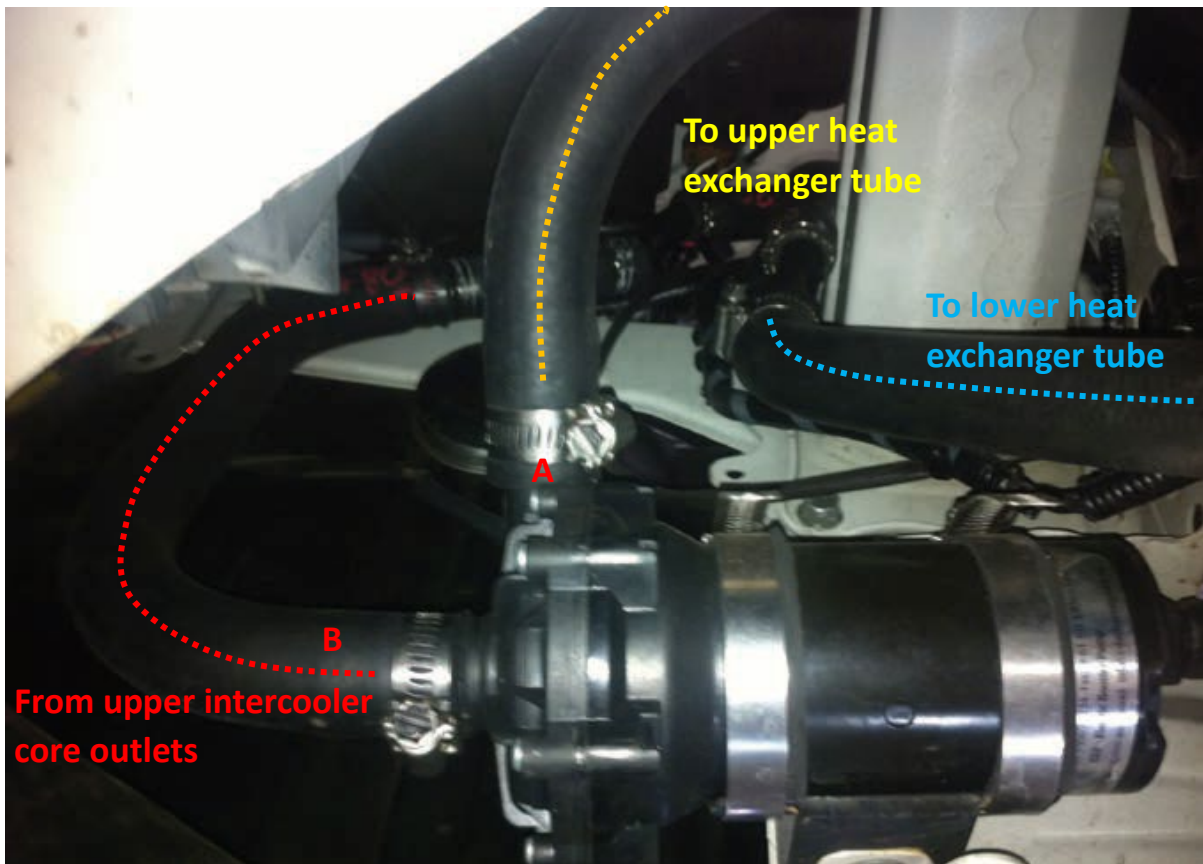



## 11) Intercooler pump wiring

- a) Remove the cover from the fuse box, un-clip and remove the side cover, un-clip the upper panel with the tabs and slide the upper panel up far enough to get to the M6 bolt on the front of the panel as shown (some assemblies require a little force to lift panel up).

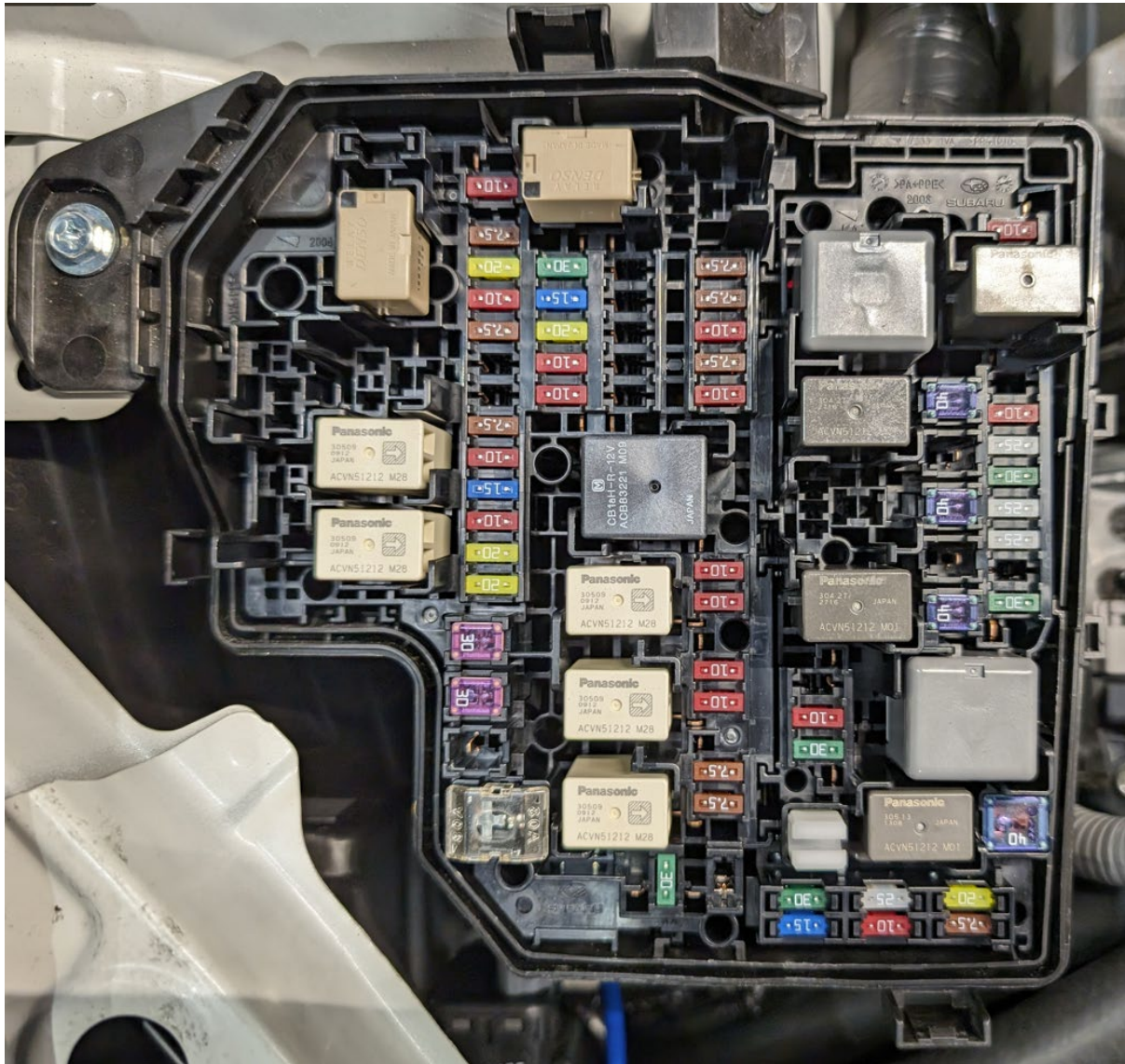



- b) Feed the red positive wire (intercooler pump loom) up from LHS opening where the side cover has been removed and install to the positive terminal shown and reinstall upper panel. Route the piggyback control wire inside the fuse box and out the inside of the side panel opening.

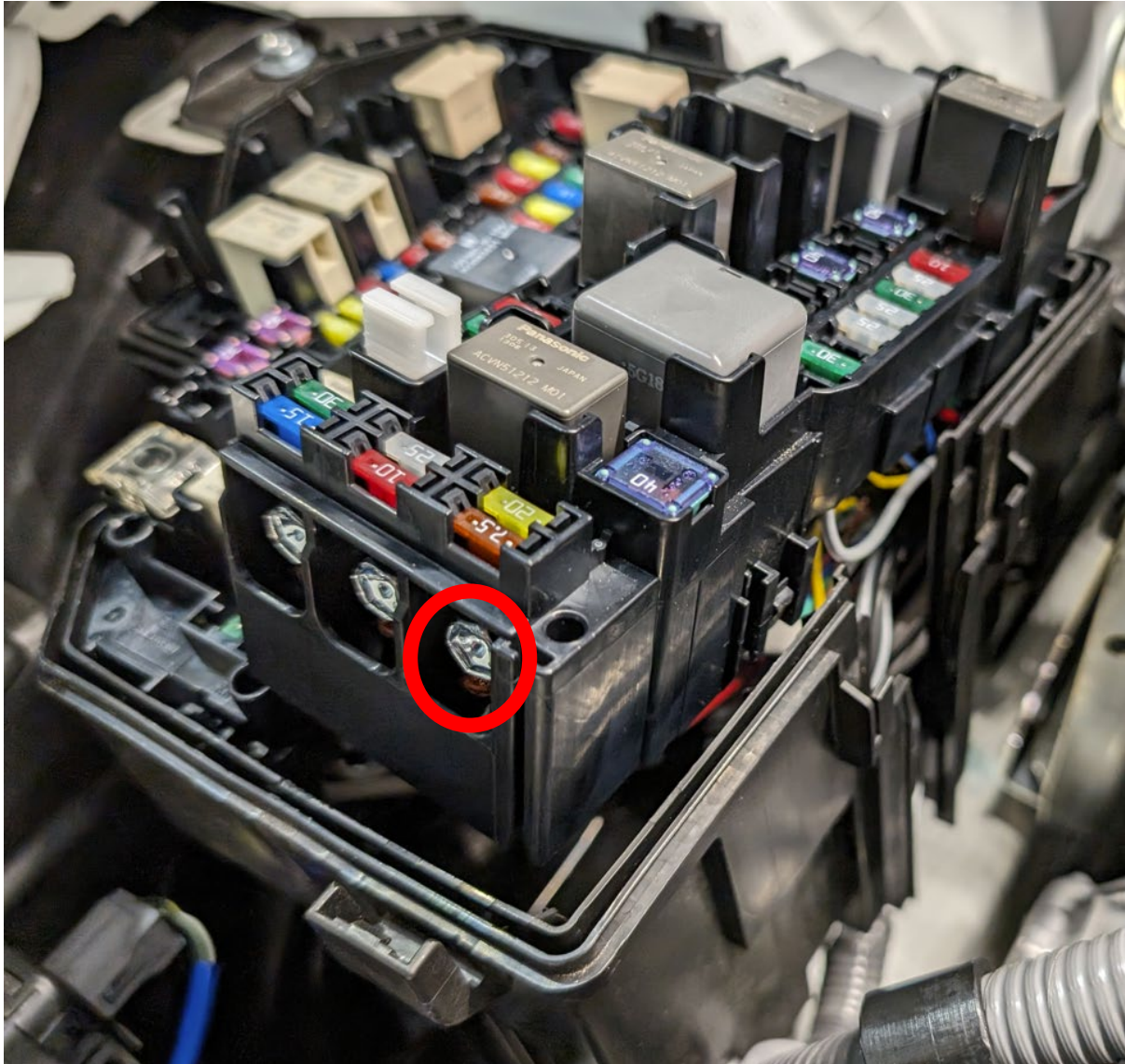

- c) Take small plastic panel from the side of the fuse box and drill a 6mm hole (in the centre 45mm from the top) to mount the intercooler pump relay. Use the supplied M5 bolt and nut to attach the relay as shown. Reinstall the plastic panel.



- d) Remove the fuse shown. Install the fuse tap into the 15 amp EFI(IGN) fuse socket and route the wiring as shown and reinstall the fuse box cover.

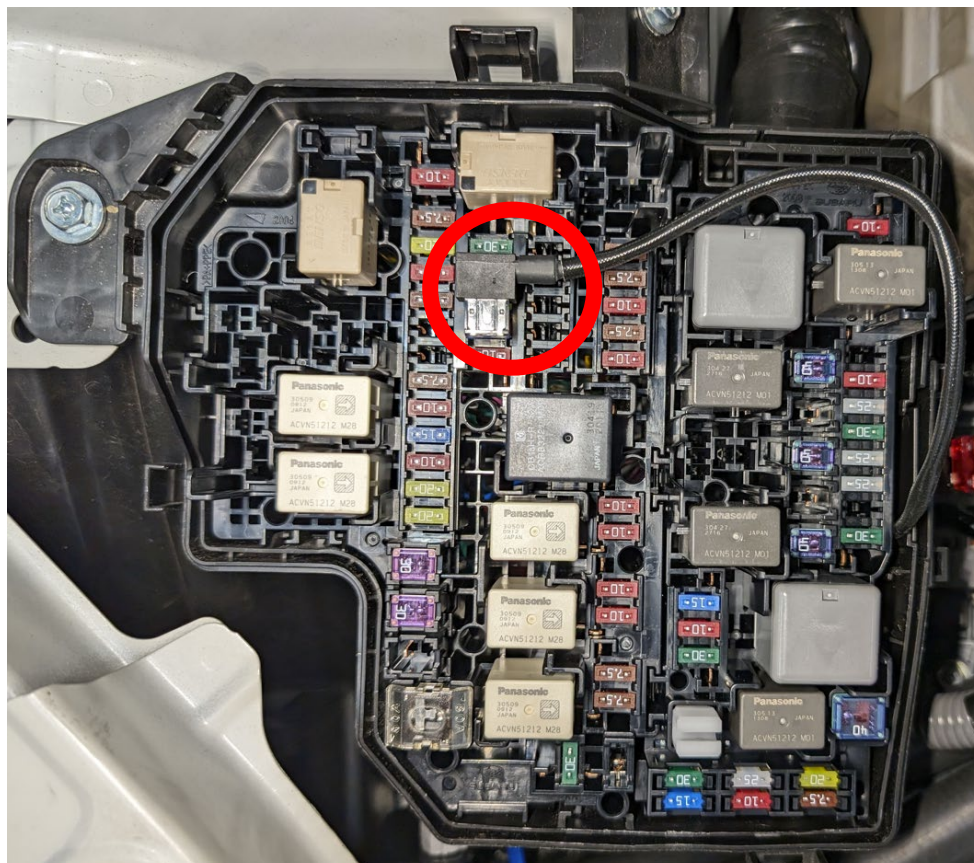



- e) Install the earth wire into the position as shown (inside RH rail). Ensure the earth and the pump loom is run under the fuse box. Feed the pump loom down towards the front between the head lamp and front chassis work as per image below.



- f) Re connect the battery.  
g) Do not run the intercooler pump for long periods without coolant in the system.



## 12) Intercooling system filling and bleeding

- a) Remove both plugs from the rear of the intercoolers.



- b) Coolant to be used is **GM6277M**, mixed with distilled or deionised water in a 50% concentrate. **Note: Filling with a noncompliant coolant will void warranty.**
- c) Begin filling the RHS intercooler. The cooling system will hold approximately 2.5l of coolant when cold.
- d) Once the coolant is visible in the LHS intercooler loosen the bleed screw on the heat exchanger (top LHS) and allow the air to purge from the heat exchanger, tighten the bleed screw after that air has purged from the heat exchanger.
- e) Once the LHS intercooler is full, install the plug but do not seal this will allow you to fill the funnel in the RHS tank and completely bleed the air from the system, fit and tighten plugs.
- f) Once this process is complete you can turn the ignition to on and allow the pump to run. It may take a few cycles of the key to remove all the air from the system. Check system and top up until all air is bled.
- g) Tighten both intercooler plugs.
- h) Leave the ignition in the on position and check the system for leaks.
- i) Re install the 2 plastic under trays.

## 13) Pre startup checks

- a) Check engine coolant level.
- b) Check engine oil level.
- c) Replace spark plugs if required.

## 14) Start engine

- a) Start the engine. (The engine may run rough while the air purges from the fuel rails). Once it has run for about half a minute stop and check that there are no fuel leaks. Once you are certain that there are no leaks, start the engine again.
- b) Allow the engine to reach operating temperature and check for any fluid leaks.
- c) Check engine oil level.
- d) Car is ready for recalibration of the ECU. Intake air temperature sensor is ATS-005-SRS-LC10. Voltage in the table below assumes a 1k $\Omega$  pullup resistor with a 5V supply.

Air temp [°C]	Resistance [ $\Omega$ ]	Voltage [V]
-20	28146	4.83
-10	15873	4.70
0	9256	4.51
10	5572	4.24
20	3457	3.88
30	2205	3.44
40	1443	2.95
50	965	2.46
60	660	1.99
70	462	1.58
80	329	1.24
90	238	0.96
100	175	0.74
110	131	0.58
120	99	0.45
130	76	0.35
140	59	0.28
150	46	0.22

## 15) Road test

- a) Once recalibration of the ECU is completed, the vehicle is ready to be road tested.
- b) Check all connections for leaks.
- c) When vehicle is cool, remove a rear intercooler plug and check coolant level and top up if required.