



## 18337 INSTALLATION INSTRUCTIONS 75-79 CHEVROLET NOVA

The enclosed Aeromotive fuel tank/pump assembly utilizes an o-ring sealed AN-06 style feed, return and vent ports. These ports seal with o-rings; they are **NOT PIPE THREAD** and utilize **NO THREAD SEALANT**.

The fuel pump used in this tank is the Aeromotive Stealth 340 (part # 11540). To insure proper pump function and fuel pump service life, we strongly recommend the following:

- Utilize AN-06 (EFI) and AN-08 (carb) size high pressure fuel lines, fittings and o-rings for all connections from the fuel tank to the engine.
- Install a 10 micron post-filter (such as P/N 12301 or 12321).
- Install the supplied aluminum remote-mount rollover valve on the vent nipple above the pump hat. It must be mounted in a vertically and as high or higher than your filler cap.
- Fuel pump wiring should be 10 gauge wire and triggered with a relay rated at a minimum of 20 amps (Aeromotive fuel pump wiring kit 16307).
- A high flow, return style regulator must be used (13109, 13303-EFI, 13204, 13304-carb). OEM style filter/regulator combos are NOT recommended, having proven unable to handle the high flow 340 Stealth Pump, causing premature pump failure.

Failure to follow the above recommendations may result in fuel leakage, bursting of the fuel lines, poor vehicle performance and/or decreased fuel pump life! Improper installation will void all warranties for this product!

340 Stealth Fuel Pump Specifications:

Fuel pump flow:	340 LPH @ 40 psi and 13.5V
Current Draw:	13 amps @ 40 psi and 13.5V
Continuous operating psi range:	3psi to 65 psi with carb or EFI bypass regulator
Continuous current draw range:	10-15 amps at pressures from 3psi to 65 psi
Pump internal By-Pass / Max Pressure:	105 psi maximum, dead-head pressure

Tank sending unit used in your new Aeromotive Stealth tank is 0-90 Ohm reading.

### CAUTION:

**Installation of this product requires detailed knowledge of automotive systems and repair procedures. We recommend that this installation be carried out by a qualified automotive technician.**

**Installation of this product requires handling of gasoline. Ensure you are working in a well ventilated area with an approved fire extinguisher nearby. Extinguish all open flames, prohibit smoking and eliminate all sources of ignition in the area of the vehicle before proceeding with the installation.**

Your new, Aeromotive Stealth Tank is but one of several important components required to construct a complete Stealth Fuel System. The remaining parts may be purchased individually or as one of four unique Stealth Completion kits. The completion kits include a high-flow fuel filter, bypass style carbureted or EFI fuel pressure regulator, the correct type and size port fittings and o-rings, and a pressure gauge.

Aeromotive offers components and kits ideal for completion of three different EFI style engines and one typical carbureted engine. The following diagrams illustrate what components are recommended, what size fuel lines are required, and give a general idea of how the plumbing is performed. The part numbers for individual components as well as the part number for each kit may be found on each system diagram.

P/N 17256 Stealth Kit to Complete For:  
**STEALTH 340** Single Feed  
 Carb - Return

*flywheel	Naturally Aspirated	Forced Induction
GAS	1,000hp	850hp

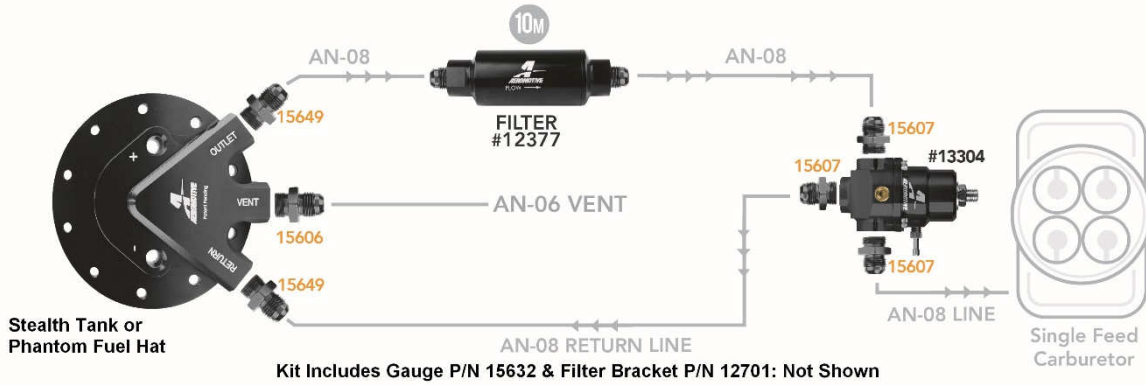

P/N 17352 Stealth Kit to Complete For:  
**STEALTH 340** Throttle Body  
 EFI Conversion

*flywheel	Naturally Aspirated	Forced Induction
GAS	850hp	700hp

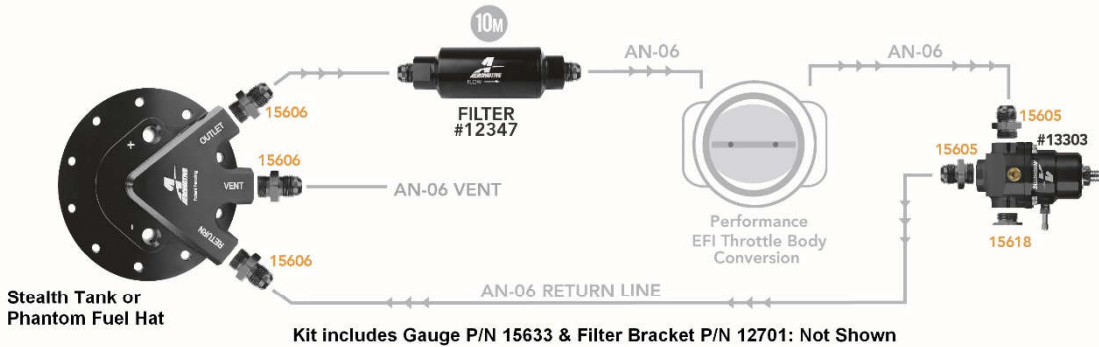

OR

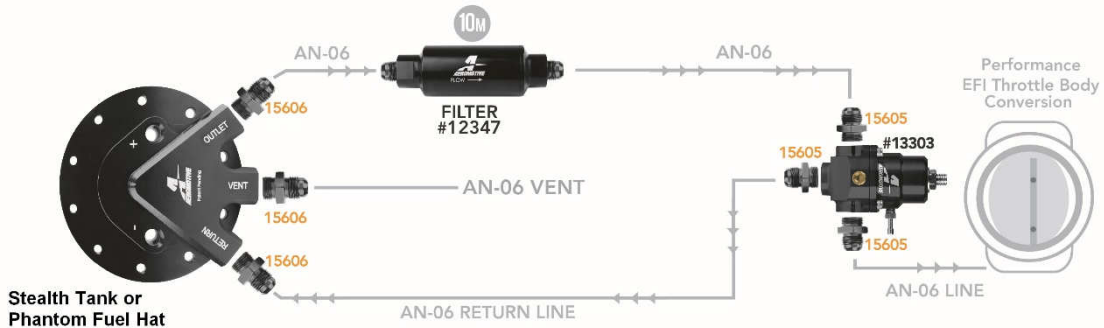

P/N 17351 Stealth Kit to Complete For:  
**STEALTH 340** OEM Fuel Rail  
 Fuel Injected

*flywheel	Naturally Aspirated	Forced Induction
GAS	850hp	700hp

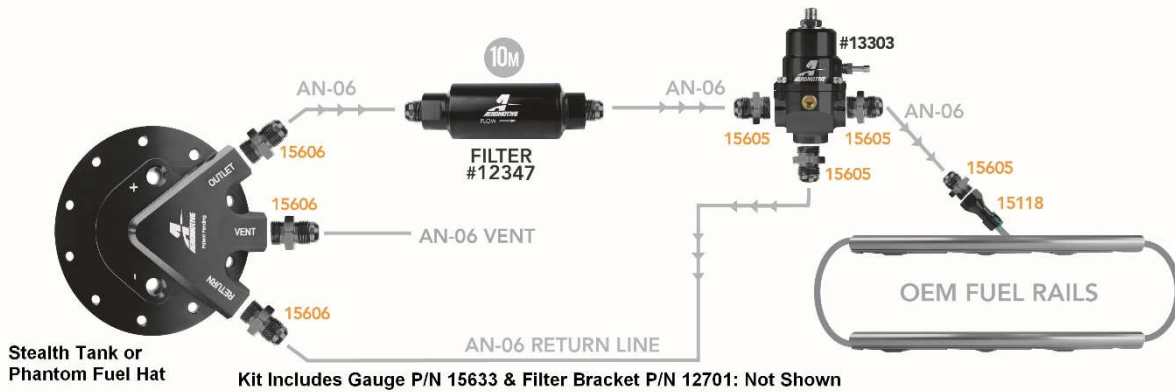

P/N 17350 Stealth Kit to Complete For:  
**STEALTH 340** Dual Fuel Rail  
 Fuel Injected

*flywheel	Naturally Aspirated	Forced Induction
GAS	850hp	700hp

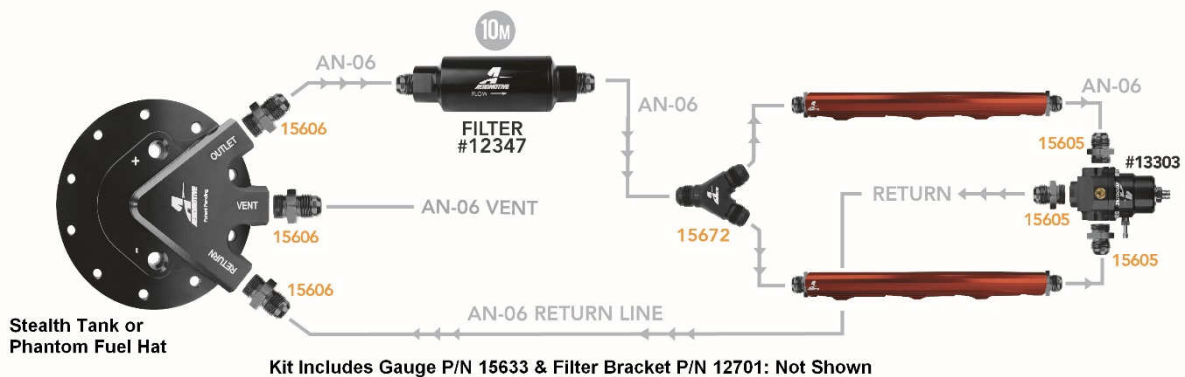

The following steps are typical of most installations:

1. Once the engine has been allowed to cool, disconnect the negative battery cable and relieve the fuel system pressure.
2. Raise the vehicle and support it with jack stands.
3. Referring to the appropriate vehicle service manual for instructions, drain, disconnect any electrical and fuel component connections and remove the OEM fuel tank.
4. Install the new Aeromotive fuel tank in the vehicle and make all the appropriate connections. For electrical wiring refer to **Figure 2-1**.

**Note: The primary tank vent is the nipple above the fuel pump. Join this to the vent in the fuel pump hat, using the included Y fitting, if the engine exceeds 500 FWHP. Plug unused vent ports.**

5. Mount the appropriate, high flow EFI or Carbureted bypass pressure regulator, as near the engine as possible, and mount it such that the feed and return lines avoid the headers and exhaust system.
6. Mount a high flow fuel filter between the fuel pump outlet and the bypass pressure regulator in a location that is easy to get to in order allow a trouble free filter inspection and service once per year.
7. Plan a safe route and secure the appropriate sized fuel feed and return lines per the applicable system diagram. EFI engines may use AN-06 or 3/8" and carbureted engines AN-08 or 1/2" lines.

**Note: Be sure to route all fuel lines clear of any moving suspension or drivetrain components, and any exhaust components! Protect fuel lines from abrasion and road obstructions or debris.**

8. Connect electrical power (12 VDC) power and ground to the pump. Aeromotive wiring kit P/N 16307 is recommended. Make sure you use stranded, insulated copper wire, in the sizes shown, with matching crimp-type connectors for all connections. **CAUTION: The pump must not be connected directly to the battery.** Connect the Aeromotive fuel pump as shown in the following diagram:

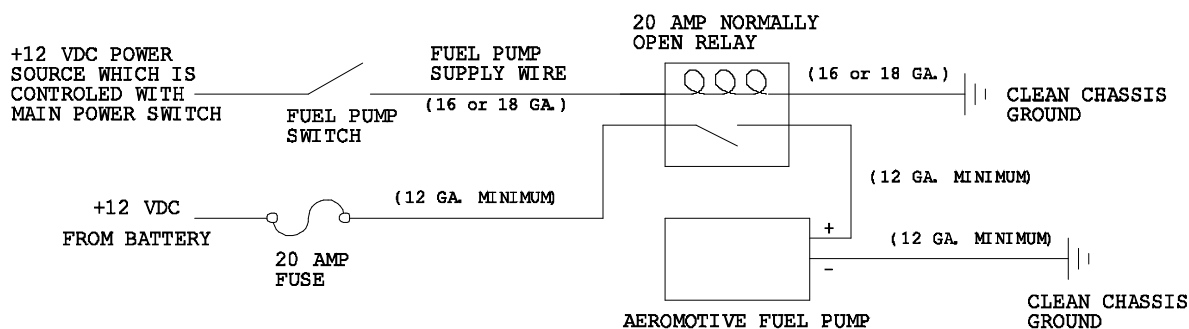

Figure 2-1

**Note: Route all electrical wires clear of any moving suspension or drivetrain components and any exhaust components! Protect wires from abrasion and road obstructions or debris.**

**CAUTION: While performing the following steps, if any fuel leaks are detected, immediately turn the fuel pump OFF, remove any spilled fuel and repair the leak(s) before proceeding!**

9. Turn the fuel pump ON **without starting the engine**, allow the pump to run for several seconds and check the fuel pressure. If no pressure, turn the fuel pump OFF, wait one minute, then turn the fuel pump ON and recheck the pressure. Repeat this fuel pump OFF and ON procedure until the fuel pressure gauge registers pressure or you detect a fuel leak. If necessary, loosen the fuel line fitting at the pressure regulator to bleed off excessive air in the system. Tighten any fuel line fittings which were loosened and insure that any spilled fuel is cleaned up and removed from the vicinity of the vehicle. If no pressure is registered on the gauge after running the pump for several seconds and you have found no leaks, check all fuel and electrical connections to determine the cause.
10. Once the fuel pressure gauge registers pressure, start the engine. The gauge on the fuel pressure regulator should register between 3 and 12 psi for carb and 35-60 for EFI. Now adjust the fuel pressure regulator to the desired setting. Test drive the vehicle to insure proper operation and recheck the fuel system for leaks. **If any leaks are found, immediately discontinue use of the vehicle and repair the leak(s)!**



**WARNING:** This product can expose you to chemicals, including chromium, which is known to the State of California to cause cancer or birth defects or other reproductive harm. For more information, visit: [www.p65Warnings.ca.gov](http://www.p65Warnings.ca.gov)

### ***AEROMOTIVE, INC. LIMITED WARRANTY***

This Aeromotive Product, with proof of purchase dated on or after January 1, 2003, is warranted to be free from defects in materials and workmanship for a period of one year from the original date of purchase. No warranty claim will be valid without authentic, dated proof of purchase.

This warranty is to the original retail purchaser and none other and is available directly from Aeromotive and not through any point of distribution or purchase.

If a defect is suspected, the retail purchaser must contact Aeromotive directly to discuss the problem, possible solutions and obtain a Return Goods Authorization (RGA), if deemed necessary by the company. Please call 913-647-7300 and dial option 3 for the technical service dept. All returns must be shipped freight pre-paid to the company and with valid RGA before they will be processed.

Aeromotive will examine any product returned with the proper authorization to determine if the failure resulted from a defect or from abuse, improper installation, misapplication or alteration. Aeromotive will then, at it's sole discretion, return, repair or replace the product.

If any Aeromotive product is determined defective, buyer's exclusive remedy is limited in value to the sale price of the good. In no event shall Aeromotive be liable for incidental or consequential damages.

Aeromotive expressly retains the right to make changes and improvements in any product it manufactures and sells at any time. These changes and improvements may be made without notice at any time and without any obligation to change the catalogs or printed materials.

Aeromotive expressly retains the right to discontinue at any time and without notice any Aeromotive product that it manufactures or sells.

This warranty is limited and expressly limits any implied warranty to one year from the date of the original retail purchase on all Aeromotive products.

No person, party or corporate entity other than Aeromotive shall have the right to: determine whether or not this Limited Warranty is applicable to any Aeromotive product, authorize any action whatsoever under the terms and conditions of this Limited Warranty, assume any obligation or liability of any nature whatsoever on behalf of Aeromotive under the terms and conditions of this Limited Warranty.

This Limited Warranty covers only the product itself and not the cost of installation or removal.

This Limited Warranty is in lieu of and expressly excludes any and all other warranties, expressed or implied. This Limited Warranty gives you specific legal rights, and you may also have other rights which vary from state to state.