



**AEROMOTIVE**  
**Part # 18090/18091**  
**2015-2020 Ford F-150 (Dual or Triple)**  
**Pump Module**  
**INSTALLATION INSTRUCTIONS**

This product is not legal for sale or use on emission-controlled vehicles except when used as a direct replacement part matching OEM specification.

**WARNING!**



Always be aware of flammable situations. Drilling and grinding can be potential ignition sources. Extinguish all open flames, prohibit smoking and eliminate all sources of ignition in the area of the vehicle and workspace before proceeding with the installation. Ensure you are working in a well-ventilated area with an approved fire extinguisher nearby.

**WARNING!**



Installation of this product requires modification to a fuel tank/ the fuel system, failure to satisfy all safety considerations will result in fire, explosion, injury and/or loss of life to yourself and/or others. All fuel system components **MUST** be located as far from heat sources as possible, like exhaust, engine block, etc.

**WARNING!**



Mechanical and hydraulic lifting devices can tip over or lower accidentally due to incorrect maneuvering or technical errors. A falling object can cause injury and/or loss of life to yourself and/or others. When working under the vehicle, always use stands, and ensure that the ground or floor is stable and level. Never crawl under a vehicle which is only supported by a jack.

**WARNING!**



The fuel system is under pressure. Do not open the fuel system until the pressure has been relieved. Refer to the appropriate vehicle service manual for the procedure and precautions for relieving the fuel system pressure.

**CAUTION!**



When installing this product always wear safety glasses and other appropriate safety apparel. A drilling operation will cause flying metal chips. Flying metal chips can cause eye injury.

**CAUTION:**



Installation of this product requires detailed knowledge of automotive systems and repair procedures. We recommend that this installation be carried out by a qualified automotive technician. Careless installation of this product can result in damage to the product, injury or loss of life to yourself and/or others.

## Compatible Fuels:

**Pump Gas**  
**Race Gas**  
**E85**

Aeromotive system components are not legal for sale or use on emission-controlled motor vehicles.

This pump assembly is a high-performance factory replacement unit. Key features:

- **Drops directly into the factory fuel tank (NO CUTTING REQUIRED).**
- **Utilizes OEM jet siphon in conjunction with factory jet siphon system plumbing.**
- **High flow pre-filter built into inlet of pump.**
- **Includes fuel level mounting bracket for factory fuel level sending unit.**

**NOTE: The use of Teflon braided line with machine crimped hose ends is recommended. This eliminates the possibility of fuel vapors permeating through the fuel line.**

Maximum continuous operating pressure should not exceed 65 psi.

The enclosed Aeromotive fuel pump utilizes AN-10 ORB (O-ring Boss Port) style for the outlet and -08 ORB for the return ports; these ports are **NOT PIPE THREAD** and utilize **NO THREAD SEALANT**.

### Pump Specifications:

	18090 Kit (Pump 2x #11145)	18091 Kit (Pump 3x #11145)
Outlet pressure/typical flow:	40 psi / 2x 381 LPH @ 13.5 V 60 psi / 2x 324 LPH @ 13.5 V	40 psi / 3x 381 LPH @ 13.5 V 60 psi / 3x 324 LPH @ 13.5 V
Continuous Operating Range:	30 psi – 65 psi @ 13.5 V	30 psi – 65 psi @ 13.5 V
Pump internal By-Pass Pressure:	120 psi	120 psi
Current Draw:	2x 15.3 amps @ 40 psi	3x 15.3 amps @ 40 psi

### Aeromotive Related Components:

#### **Fuel Filters:**

12341 10 micron microglass ORB-12  
 12350 10 micron microglass ORB-10  
 12305 filter bracket

#### **Check Valves:**

15107 (10AN)

#### **Fuel Pressure Regulators:**

13305 (-8 ORB ports)

#### **Fuel Pressure Gauge:**

15633 (dry 0-100psi)

#### **Outlet Cap Port Fittings:**

15607 (-8 ORB x -8 AN Male)  
 15608 (-10 ORB x -10 AN Male)  
 15610 (-10 ORB x -08 AN Male)  
 15139 (3/8" MNPT x 5/8 Quick Connect) – Included  
 15140 (-06 ORB x 5/16 Quick Connect) - Included

#### **Electrical Components:**

16307 (30A pump wiring kit)  
 16308 (60A pump wiring kit)

#### **Direct Injection High Pressure Pump Inlet Tee Fitting:**

15137 (2x -08 ORB Port x 3/8 Quick Connect)

**NOTE:** This pump module installation requires an experienced tuner/installer that is familiar with integrating the OEM direct injection system with a supplemental fuel system. This system is intended to fuel both the OEM direct injection system in conjunction with a supplemental fuel system. Integrating the direct injection wiring and plumbing with the supplemental wiring and plumbing should only be done by an experienced tuner/installer. Upgraded wiring is required to power the fuel pumps installed on this pump module. 10 gauge wire is recommended for powering an individual pump and 8 gauge wire is recommended for powering two pumps simultaneously. Part number 18091 (Triple 450 Pumps) requires 8 gauge wire to power the "Aux" terminals.

Vent Port - 3/8 FNPT (Use provided fitting PN: 15140 (3/8 MNPT x 5/8 Quick Connect))

Aux. Pump "+" Terminal

Aux. Pump(s) Ground Terminal "-"

Main Pump "+" Terminal

Main Pump Ground Terminal "-"

Return Port (-08 ORB)

Common Pump Outlet -10 ORB

Fuel Level Terminals

Alignment Indicating Mark

Vent Port -06 ORB (Use provided fitting PN: 15139 -06 ORB x 5/16 Quick Connect)

### OUTLET CAP LAYOUT

The following steps are typical of most installations:

1. Drain the fuel tank, relieve system pressure (refer to service manual for proper procedure), and disconnect the battery.
2. Remove the fuel tank from the vehicle following the manufacturer's suggested procedure (refer to service manual for proper procedure).
3. Remove the fuel line and vent tube by pressing the tabs on the quick connect fittings and unplug the wire connectors. Be sure to not damage the vent tube as this will be reconnected to the new outlet cap. Wipe the top of the fuel pump module clean to limit the amount of dirt and debris that can fall into the tank.



Remove Vent Tube – Save for Reassembly



4. Remove the lock ring from the top of tank. Remove the pump module from the tank by carefully lifting up on the module and then disconnecting the internal vent tube. **Note: The internal tank quick connect hose is reused, do not cut or destroy fittings during disassembly.** Be careful not to spill fuel or damage the fuel level sending unit during removal.

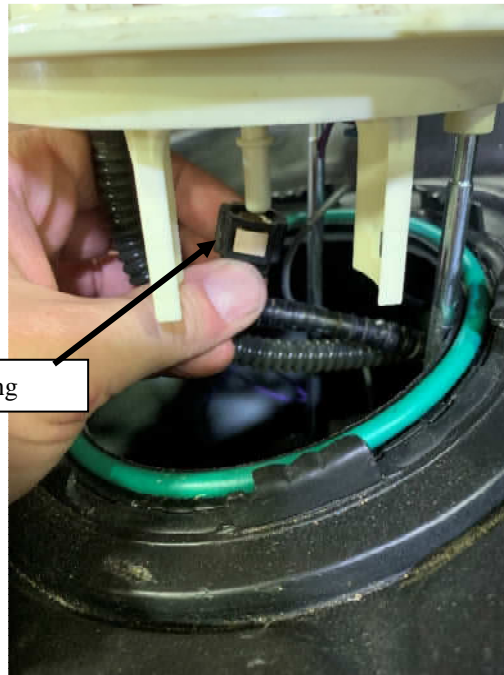

Remove Internal Vent Quick Connect Fitting

**CAUTION: Immediately wipe up any fuel spills from the hoses.**

5. Once the OEM fuel pump module is fully removed from the tank, carefully remove the fuel level sender from the OEM fuel bucket. To do this, depress the small tab shown in the following image, a small flat screwdriver is helpful for this step. Slide the fuel level sender down to remove from the fuel bucket. Unplug the fuel level sender wires from the bottom of the OEM fuel outlet cap.

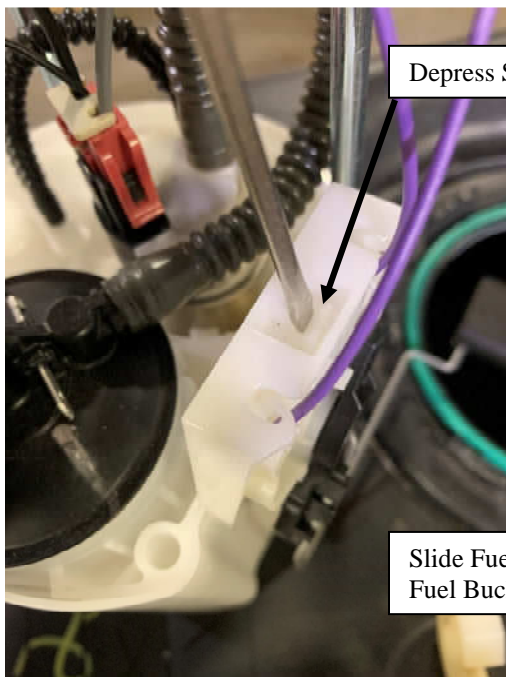

Depress Small Tab to Release from Fuel Bucket

Slide Fuel Level Sender Down to Remove from Fuel Bucket

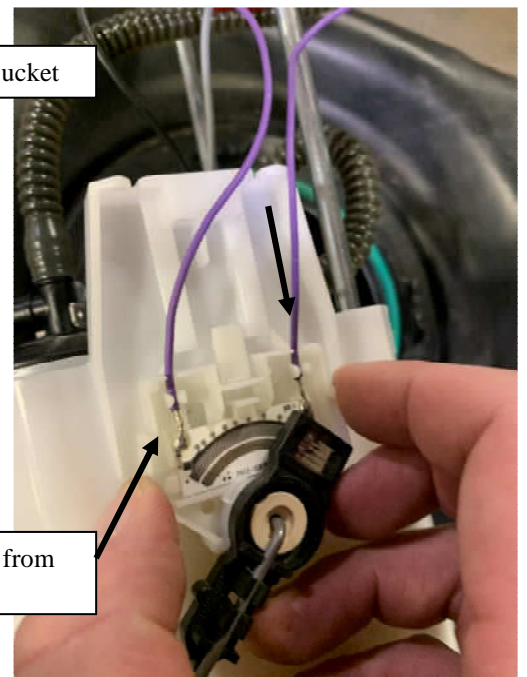

6. Cut the wires from the fuel level sender near the plug as shown in the below image, leave as much wire length as possible on the fuel level sender.

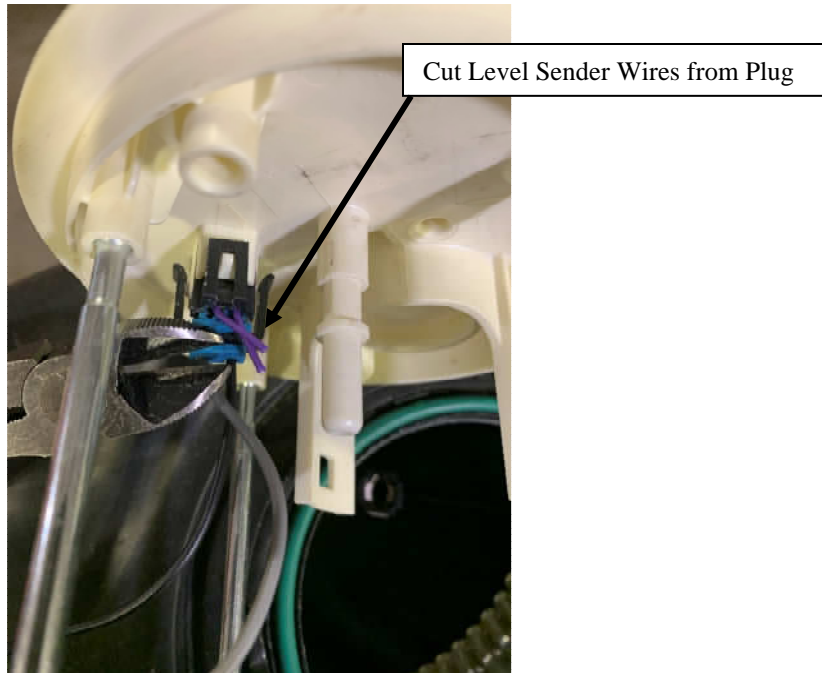

7. Strip the ends of the wires from the fuel level sender. Crimp on the new male blade connectors as shown in the following image.



8. Attach the OEM fuel level sender to the Fuel Level Sender Mounting Bracket as shown in the below image. To do this, simply slide the fuel level sender on the bracket until the small plastic tab is captured by the small tab on the bracket. See picture below. **Note: The fuel level sender bracket is made to be used with two different tank depths. The 23-gallon tank is commonly used in the short wheelbase trucks and measures approximately 11.50" from the fuel pump hole in the tank. The 36-gallon tank is commonly used in the longer wheelbase trucks and measures approximately 9.75" from the fuel pump hole in the tank. The fuel level sender should be placed on the correct bracket position based on the tank depth. See pictures below:**

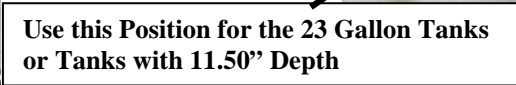
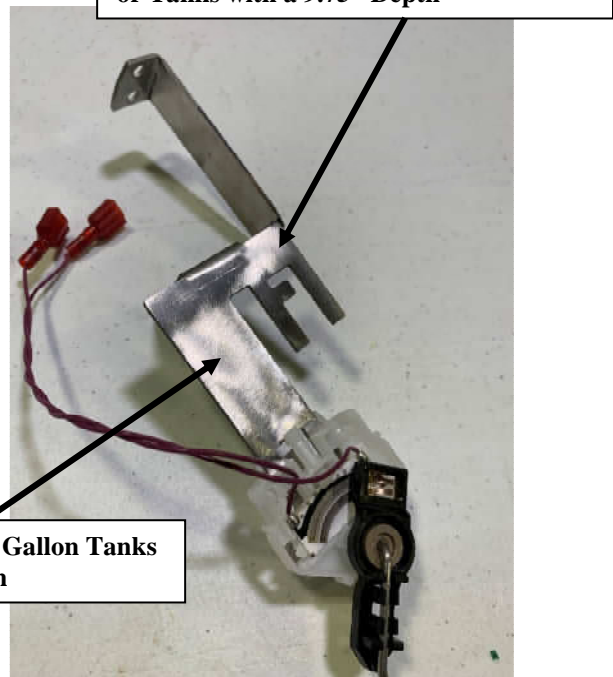
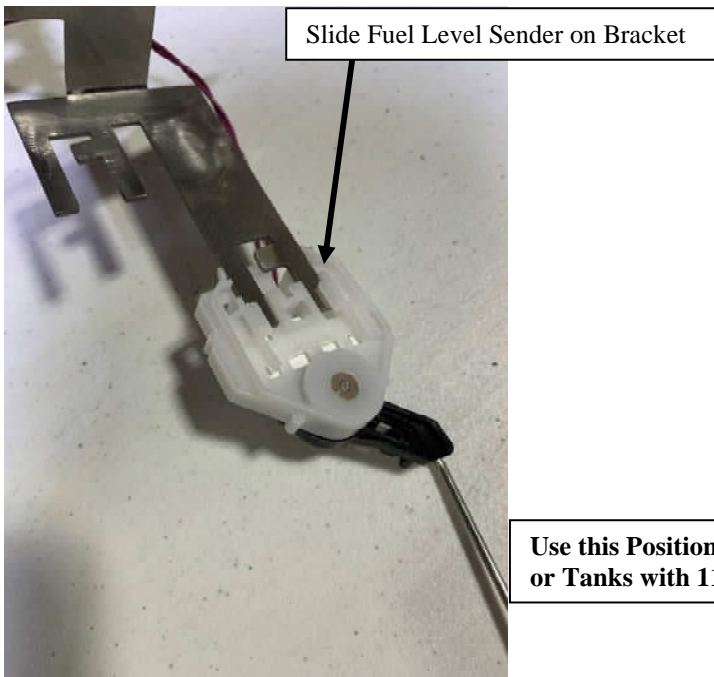

9. The pump assembly is height adjustable to accommodate the two different tank depths mentioned above. To adjust the pump assembly to your tank's specific depth, see the pictures below. **Note: The pump spacer when flush with the bottom of the pump hanger rod is set for the 11.50" tank depth (23-gallon tank). If your tank is 9.75" deep (36-gallon tank), you will need to adjust the depth of the pumps and return line, see pictures below.**



First, Loosen the Socket Head Cap Screw (Use 5/32 Allen Wrench) and Slide the Return Hose Bracket Up the Pump Hanger Rod Until It Can't Go Any Farther Due to the Rod Bend. Tighten Screw Once the Bracket is in the Correct Position.

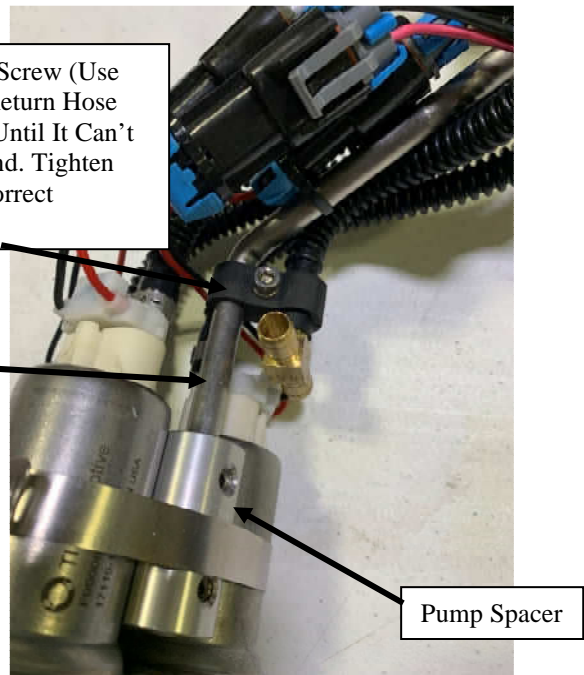

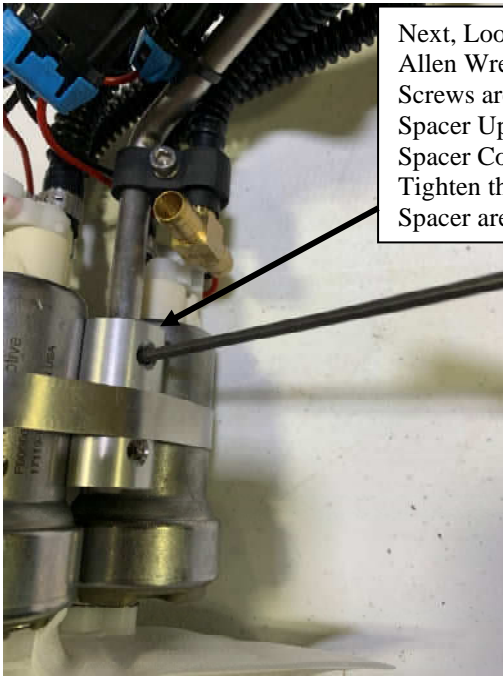

Next, Loosen the Two Set Screws (Use 1/8" Allen Wrench) in the Pump Spacer. Once the Screws are Loose, Slide the Pumps and Pump Spacer Up the Pump Hanger Rod Until the Pump Spacer Contacts the Return Hose Bracket. Tighten the Set Screws Once the Pumps and Spacer are in the Correct Position.

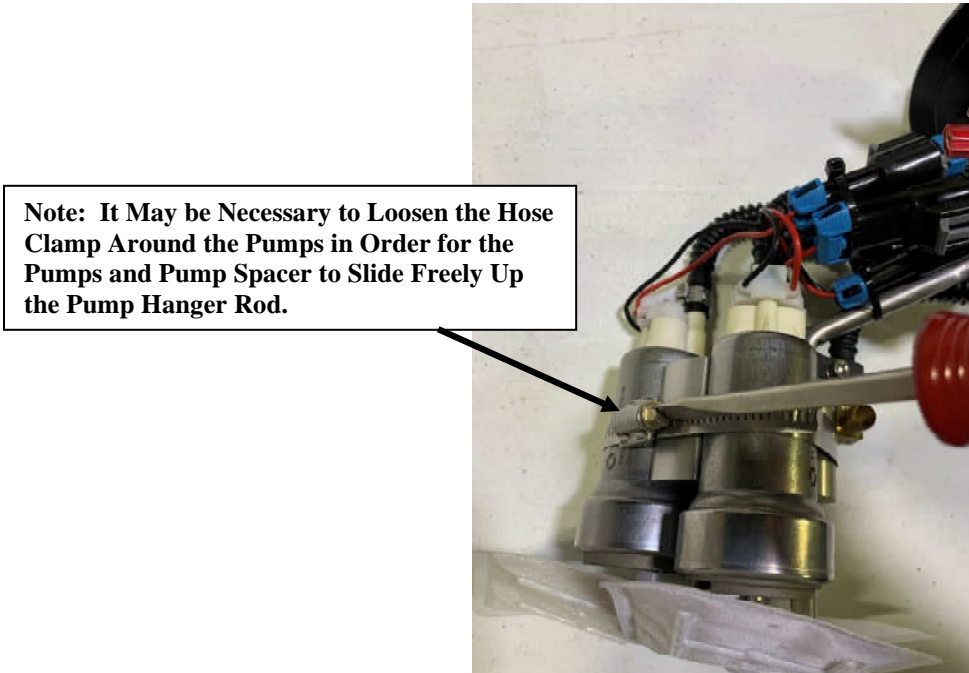
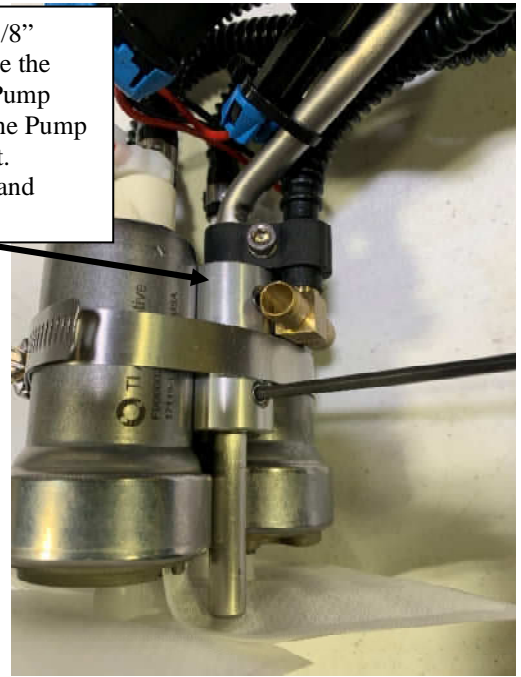

**Note: It May be Necessary to Loosen the Hose Clamp Around the Pumps in Order for the Pumps and Pump Spacer to Slide Freely Up the Pump Hanger Rod.**

10. If they are not already installed; install each fuel pump strainer (pre-filter) on each fuel pump.



11. Next, install the provided foam and basket assembly into the tank. To do this, fold the foam and basket in half and insert into the tank. Once inside the tank, the foam and basket should be positioned to the left and towards the front of the tank. See pictures below.

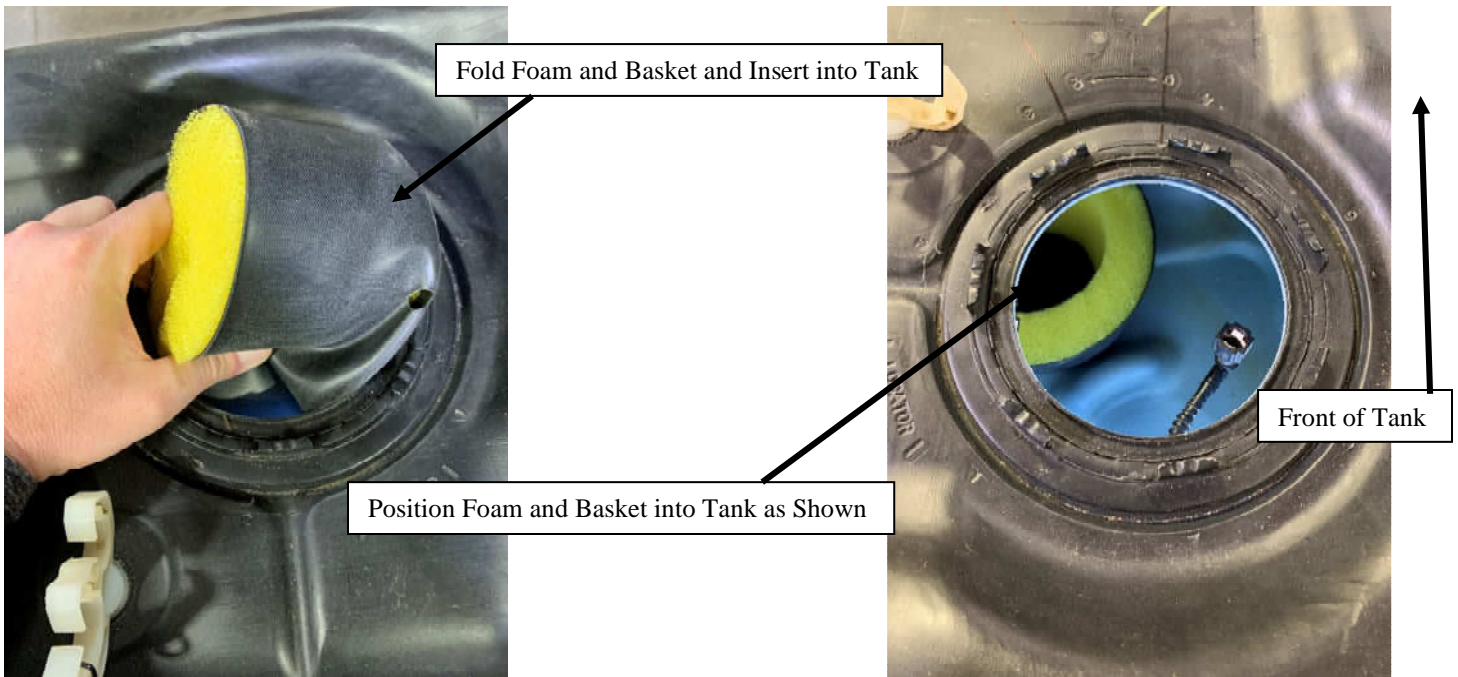

12. Once the foam is correctly positioned in the tank, loosely insert the pump assembly through the hole. The pumps need to land in the center of the foam and basket assembly. **Note: The pumps are more easily positioned in the foam and basket if the pump assembly is rotated slightly when inserting into the tank.** See pictures below.

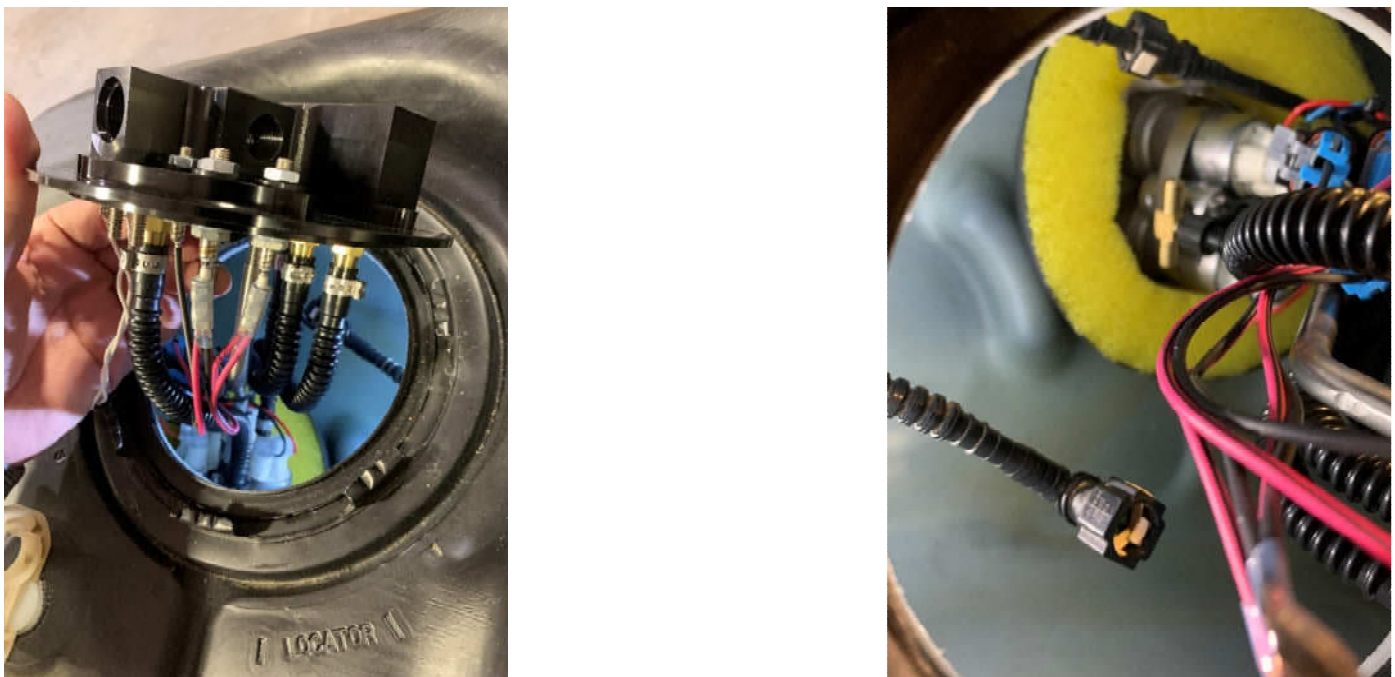

13. Once the pump assembly is loosely inserted inside the tank, connect the internal tank vent fitting and hose to the 5/16" quick connect fitting shown in the image below. Ensure the connector is fully engaged and is secured on the fitting; the fitting should "click" when fully engaged.



Attach Internal Vent Fitting and Hose to 5/16" Quick Connect Fitting



14. Next, install the fuel level sender and fuel level sender bracket into the tank. To do this, move the pump assembly towards the outboard side of the tank (side opposite of the driveshaft) to gain extra room to install the fuel level sender. Once the pump is out of the way, loosely insert the fuel level sender and bracket assembly into the tank. Next, connect the two wires from the fuel level sender to the two white wires connected to the bottom of the outlet cap from the (LVL) terminals. See pictures below.

Loosely Insert Fuel Level Sender and Bracket into the Tank.



Connect Fuel Level Sender Wires to the White Wires from the Outlet Cap.

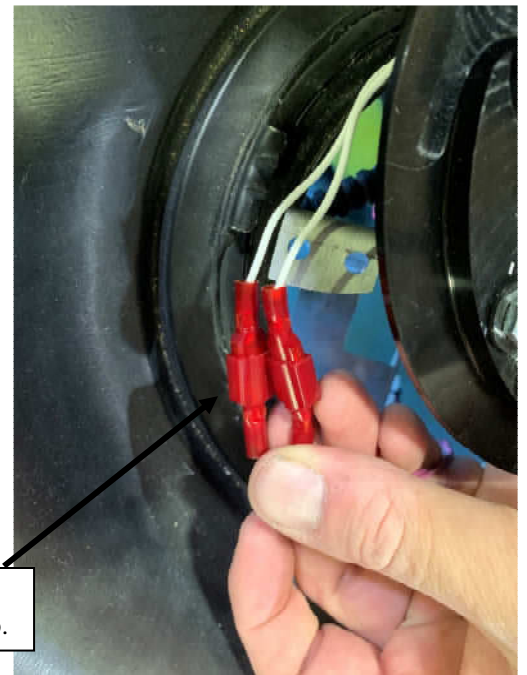

15. Next, position the fuel level sender bracket on the bottom of the Outlet Cap. There are two 10-24 stainless steel studs on the bottom of the Outlet Cap that the fuel level sender bracket will attach to. Position the bracket on the studs and connect to the Outlet Cap with the two provided 10-24 Nyloc nuts. **Note: A small 3/8" wrench works well to tighten the 10-24 nuts.** See pictures below.

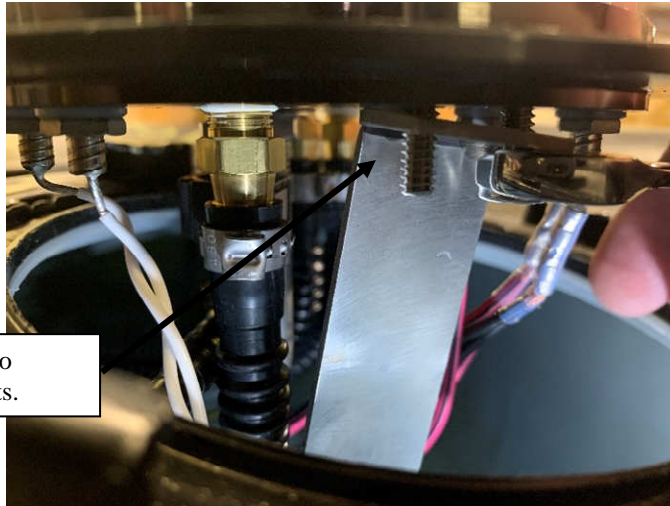

Connect Fuel Level Sender Bracket to Outlet Cap with 2 – 10-24 Nyloc Nuts.

16. Once the internal tank vent hose and fuel level sender wire connections are made, install a new tank gasket (not included) around the outlet cap and position in the tank seal groove. Ensure the gasket is properly seated in the groove prior to fully installing the fuel pump assembly. **Note: Ensure the pumps are still positioned correctly within the foam and basket assembly before fully installing the pump in the tank.**



Install New Gasket Prior to Fully Pushing the Pump Assembly into the Tank.

17. Rotate the pump assembly to align the marking on the outlet cap with the “Locator” marking on the tank. The correct position of the Outlet Cap is shown in the picture below. **Note: Ensure the Outlet Cap is properly aligned prior to securing the lock ring, the fuel level sender will read incorrectly if the markings are misaligned, or the Outlet Cap is incorrectly positioned.**

Position Outlet Cap as Shown to Allow for Correct Operation of the Fuel Level Sender

5/8" Quick Connect x 3/8" NPT Fitting (Use Thread Sealant)

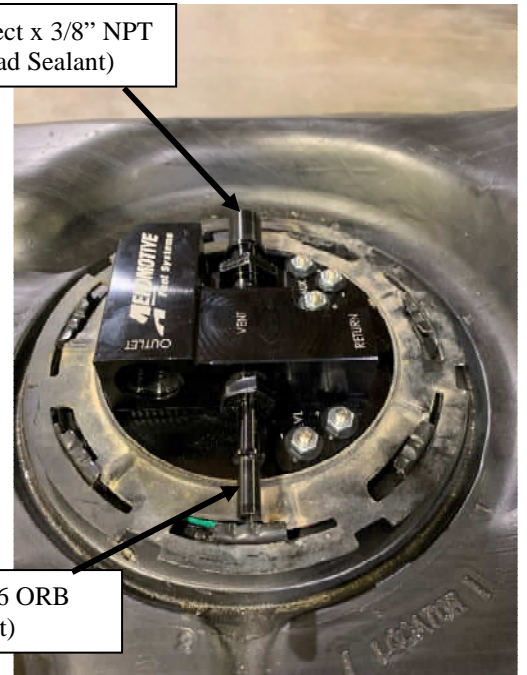

5/16" Quick Connect x -06 ORB Fitting (No Thread Sealant)

18. Once the markings are properly aligned, secure the pump assembly to the tank with the OEM lock ring.
19. If not already installed; install the two provided Vent Port quick connect fittings in their corresponding outlet cap ports. See picture above. Then re-install the external vent tube on the outside of the tank that was removed during disassembly. Secure the quick connect fitting and push the tube back into its position as shown in the picture below.

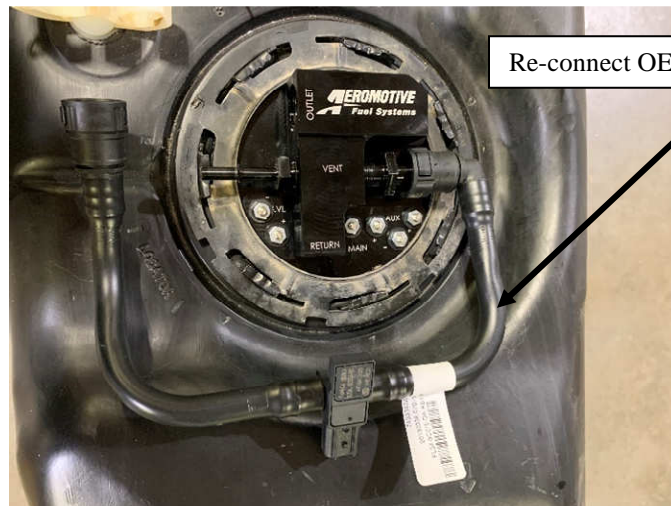

Re-connect OEM Vent Tube to Outlet Cap

20. As mentioned above, upgraded wiring is required to power the new pumps, wiring the pumps to feed the OEM direct injection fuel system to work in conjunction with the supplemental fuel system should only be performed by an experienced tuner/installer. Connect electrical power (12 VDC) to each of the fuel pump power terminals. Make sure you use stranded, insulated copper wire, in the sizes shown, with matching crimp-type connectors for all connections. **CAUTION: The pump must be connected through a fused power source and not connected directly to the battery.** Connect each of the Aeromotive fuel pumps as shown in the following diagram: **NOTE: ONE RELAY AND FUSE PER PUMP "SIDE" (MAIN OR AUXILIARY TERMINALS).**

## Wiring (per Pump)

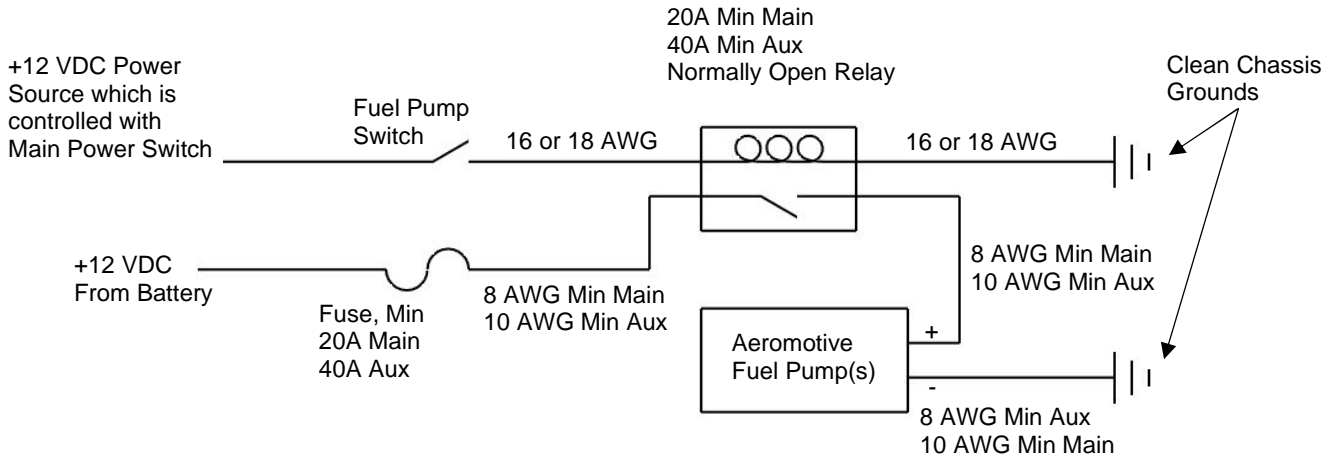

21. Run all necessary increased/upgraded plumbing and wiring to the outlet cap. **Note: A 90 degree -10 ORB x -10 or -08 direct port hose end works best to route the fuel feed line out of the outlet cap (i.e. Fragola PN: 689781BL or PN: 689710BL). A -08 90-degree hose end works best to route the return fuel line from the outlet cap.** Route the fuel lines under the vehicle being sure to keep them away from heat and moving suspension components. Each pump terminal set (Main and Auxiliary) for 18090/18091 kits will need its own relay and power wire. Aeromotive offers wiring kits, PN: 16307 and 16308, which may be used.

**CAUTION: While performing the following steps, if any fuel leaks are detected, immediately turn the fuel pump OFF, remove any spilled fuel and repair the leak(s) before proceeding!**

22. Turn the fuel pump(s) ON **without starting the engine**, allow the pump to run for several seconds and check the fuel pressure. If there is no pressure, turn the fuel pump OFF, wait one minute, then turn the fuel pump ON and recheck the pressure. Repeat this fuel pump OFF and ON procedure until the fuel pressure gauge registers pressure or you detect a fuel leak. It may be necessary to loosen the fuel line fitting at the pressure regulator to bleed off excessive air in the system. Tighten any fuel line fittings which were loosened and ensure that any spilled fuel is cleaned up and removed from the vicinity of the vehicle. If no pressure is registered on the gauge after running the pump for several seconds and you have found no leaks, check all fuel and electrical connections to determine the cause.
23. Once the fuel pressure gauge registers pressure, start the engine. The gauge on the fuel pressure regulator should register between 35 and 60 psi. Adjust the fuel pressure regulator to the desired setting.
24. Test drive the vehicle to ensure proper operation and re-check the fuel system for leaks. **If any leaks are found, immediately discontinue use of the vehicle and repair the leak(s)!**

## Contact Us

RGA NUMBER REQUIRED FOR ALL RETURNS TO AEROMOTIVE.

To obtain an RGA number, please call (913) 647-7300 and ask for the Returns and Repairs department or complete the online form under the "Rebuilds" section at [www.aeromotiveinc.com](http://www.aeromotiveinc.com).

- **Shipping & Returns**  
Aeromotive Inc.  
11414 W 79th Street.  
Lenexa, KS 66214

**General Inquiries and Tech Line:** (913) 647-7300

**General Email:** [info@aeromotiveinc.com](mailto:info@aeromotiveinc.com)

**Tech Email:** [tech@aeromotiveinc.com](mailto:tech@aeromotiveinc.com)

*The Aeromotive Tech Lines are open Monday through Friday from 9:30AM to 5:00PM Central Standard Time.*



**WARNING:** This product can expose you to chemicals, including chromium, which is known to the State of California to cause cancer or birth defects or other reproductive harm. For more information, visit: [www.p65Warnings.ca.gov](http://www.p65Warnings.ca.gov)

### ***AEROMOTIVE, INC. LIMITED WARRANTY***

This Aeromotive Product, with proof of purchase dated on or after January 1, 2003, is warranted to be free from defects in materials and workmanship for a period of one year from the original date of purchase. No warranty claim will be valid without authentic, dated proof of purchase.

This warranty is to the original retail purchaser and none other and is available directly from Aeromotive and not through any point of distribution or purchase.

If a defect is suspected, the retail purchaser must contact Aeromotive directly to discuss the problem, possible solutions and obtain a Return Goods Authorization (RGA), if deemed necessary by the company. Please call 913-647-7300 and dial option 3 for the technical service dept. All returns must be shipped freight pre-paid to the company and with valid RGA before they will be processed.

Aeromotive will examine any product returned with the proper authorization to determine if the failure resulted from a defect or from abuse, improper installation, misapplication or alteration. Aeromotive will then, at it's sole discretion, return, repair or replace the product.

If any Aeromotive product is determined defective, buyer's exclusive remedy is limited in value to the sale price of the good. In no event shall Aeromotive be liable for incidental or consequential damages.

Aeromotive expressly retains the right to make changes and improvements in any product it manufactures and sells at any time. These changes and improvements may be made without notice at any time and without any obligation to change the catalogs or printed materials.

Aeromotive expressly retains the right to discontinue at any time and without notice any Aeromotive product that it manufactures or sells.

This warranty is limited and expressly limits any implied warranty to one year from the date of the original retail purchase on all Aeromotive products.

No person, party or corporate entity other than Aeromotive shall have the right to: determine whether or not this Limited Warranty is applicable to any Aeromotive product, authorize any action whatsoever under the terms and conditions of this Limited Warranty, assume any obligation or liability of any nature whatsoever on behalf of Aeromotive under the terms and conditions of this Limited Warranty.

This Limited Warranty covers only the product itself and not the cost of installation or removal.

This Limited Warranty is in lieu of and expressly excludes any and all other warranties, expressed or implied. This Limited Warranty gives you specific legal rights, and you may also have other rights which vary from state to state.