

Edelbrock[®]

SUPERCHARGERS



Edelbrock Supercharger

2019-2021 GM Truck 1500 5.3L and 6.2L

2020-2021 GM SUV 1500 5.3L and 6.2L

Excluding 2019 Silverado LD and Sierra LDT

Part #15665, 15666, 156650 and 156660



WARNING!

The supercharger bypass valve is factory installed and adjusted intended to be vacuum operated only. DO NOT move the solenoid actuator lever by hand or adjust the stop point. Moving the lever manually will damage the solenoid and the system will not function properly. Damage to the bypass assembly from manual movement will not be covered under manufacturer warranty.



ATTENTION!

READ BEFORE ANY PARTS REMOVAL!

GM offered different variations of water pumps on the 2019 and newer trucks. Before beginning any parts removal or installation, inspect the water pump on the truck and compare to the two images below. Note that the image on the right has a machined surface and two threaded holes compared to the unmachined surface of the pump on the left.

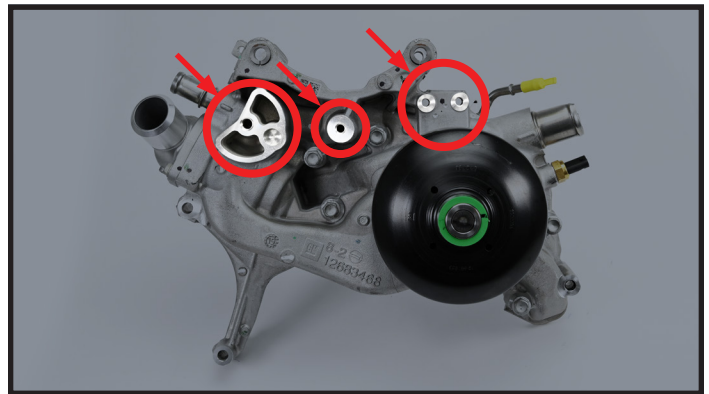
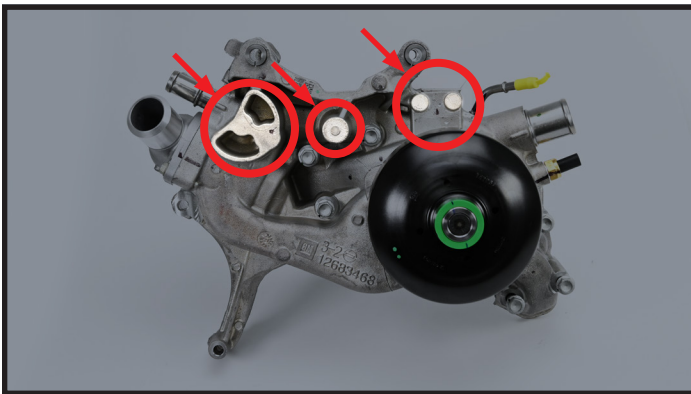

If your truck does not have the pump with the machined surface and threaded holes like the one on the right, you will need to replace the water pump before proceeding with the supercharger installation.

GM Part # 12707680 is a replacement water pump listed for a 6.6L gas engine application, but this is also the correct pump for 2019-2021 5.3L and 6.2L applications, and is the same as the early production pumps that came on these trucks as pictured on the right. If your water pump looks like the one on the left, you will need to purchase this water pump and swap it as part of the supercharger installation.

If you are swapping the water pump, you will also need an AC Belt GM Part # 12699889. Removal of the water pump requires unbolting the AC compressor, and removal of the belt involves cutting it off.

Follow the instructions in a GM service manual to remove and replace both the AC compressor and the water pump. This should not involve removing the refrigerant lines so no recharging of the system is needed.



INTRODUCTION

Thank you for purchasing the Edelbrock Supercharger System for the 2019-2021 GM 1500 Trucks and 2020-2021 SUVs (excluding the 2019 Silverado LD and the 2019 Sierra LDT). This system utilizes R2650 Eaton Gen VI TVS Supercharger rotors housed inside of our Dual Pass-3 Core intercooled rotor case. Paired with bolt-on runners, and a redesigned lid, this new package will fit under the factory hood with no modifications to the stock body or hood. The supercharger features an inverted design which expels air upward and through the first pass of the intercooler. Air pressure then builds in the plenum, before being drawn down through the intercooler core another time.

The supercharger is 50-state emissions legal, and includes a 3-year 36,000 mile warranty, where applicable, so there are no worries when installing on a brand new vehicle. Tuning the vehicle to specification different from those specified by Edelbrock, LLC will void the warranty, may cause engine damage, and will make the vehicle no longer compliant to emissions regulations,

TOOLS AND SUPPLIES REQUIRED

- Ratchet and Socket Set including but not limited to: 7mm, 8mm, 10mm (standard, deep and swivel), 11mm, 12mm, 13mm and 15mm
- Breaker Bar: 1/2"
- Allen Wrenches: 5mm, 6mm
- Torx Drives: T15, T30
- Panel Puller
- Flat Blade & Phillips Screwdrivers
- Coolant Drain Bucket
- 50/50 Coolant Mixture (4.5 quarts)
- Side Cutters
- Torque Wrench
- Pliers OR Hose Clamp Removal Tool
- Blue and Red Thread Retaining Compound
- O-ring Lube
- Masking Tape
- Shop Rags
- Wire Ties



IMPORTANT WARNINGS

Before beginning the installation, use the enclosed checklist to verify that all components are present in the box then inspect each component for damage that may have occurred in transit. If any parts are missing or damaged, contact Edelbrock Technical Support (800-416-8628), not your parts distributor.



WARNING: Installation of this supercharger will result in a significant change to the performance characteristics of your vehicle. It is highly recommended that you take some time to familiarize yourself with the added power and how it is delivered. This must be done in a controlled environment. Take extra care on wet and slippery roads as the rear tires will be more likely to lose traction with the added power. It is never recommended to turn off your vehicles traction control system.

Proper installation is the responsibility of the installer. Improper installation will void all manufacturer's standard warranties and may result in poor performance and engine or vehicle damage.

Inspect all components for damage that may have occurred in transit before beginning installation. If any parts are missing or damaged, contact Edelbrock Technical Support, not your parts distributor.

Due to the complexity of the Edelbrock E-Force Supercharging system, it is recommended that this system only be installed by a qualified professional with access to a service lift, pneumatic tools, and a strong familiarity with automotive service procedures. To qualify for the optional supplemental warranty, it is necessary to have this system installed by a Certified ASE Technician at a licensed business, GM Dealership, or an Authorized Edelbrock Installer. Failure to do so will void and/or disqualify any and all optional supplemental warranties offered with this system. Please contact the Edelbrock Technical Support department if you have any questions regarding this system and/or how your installer of choice will affect any warranty coverage for which your vehicle may qualify.

Any previously installed aftermarket tuning equipment must be removed and the vehicle returned to an as stock condition before installing the supercharger.

Any equipment that directly modifies the fuel mixture or ignition timing of the engine can cause severe engine damage if used in conjunction with the Edelbrock E-Force Supercharger System. This includes, but is not limited to: OBDII programmers, MAF sensors, adapters and any other device that modifies signals to and/or from the ECU. Aftermarket bolt-on equipment such as underdrive pulleys or air intake kits will also conflict with the operation of the supercharger and must be removed prior to installation. Use of any of these products with the E-Force Supercharger could result in severe engine damage.

IMPORTANT WARNINGS (CONTINUED)

Please employ proper towing etiquette when towing steep grades. Turn off Air Conditioner and avoid aggressive towing behaviors to avoid any overheating that may occur. **DO NOT** exceed the manufacturer's maximum tow rating for the vehicle.



91 octane or higher gasoline is required at all times. If your vehicle has been filled with anything less, it must be run until almost dry and refilled with 91 or higher octane gasoline twice prior to installation.

Any failures associated with not using premium 91 octane gasoline or higher, will be ineligible for warranty repairs.

It is also recommended that you check the Edelbrock Tech Center Website for any updates to this installation manual. Please refer to the lower right hand corner to verify that you have the latest revision of this installation manual before beginning the installation.

Tech Center: http://www.edelbrock.com/automotive_new/misc/tech_center/install/index.php



WARNING: Installation of this supercharger and charge air cooler may require removal and replacement of front grille, front bumpers, or other pieces which may be equipped with Advanced Driver Assistance Systems (ADAS). ADAS Systems include, without limitation:

- Forward Collision Warning
- Auto braking
- Lane Departure Warning
 - Lane Keeping Assist
 - Blind Spot Warning
 - Rear Cross Traffic
 - Rearview Camera
 - And various other OEM ADAS Equipment

It is the responsibility of the installer to ensure that all necessary ADAS systems that require post-repair calibrations/targeting/aiming is performed by qualified repair facilities. Edelbrock assumes no liability whatsoever with respect to any damages or losses with respect to any ADAS systems.

Edelbrock Authorized Installer Disclaimer

Authorized installers of Edelbrock products are independent companies over which Edelbrock has no right of control. Edelbrock LLC makes no claims regarding the abilities, expertise or competency of individual employees of any authorized installer. Each authorized installer is an independent company and makes its own independent judgments. Edelbrock LLC specifically disclaims any responsibility to any party including third parties for the actions, or the failure to act, of individuals, agents or a company authorized in the installation of Edelbrock LLC products.

INSTALLATION HARDWARE IDENTIFICATION GUIDE

(Parts Are Not To Scale)

BAG #1 - FEAD HARDWARE				
Item	P/N	QTY.	Description	Torque Spec
1	36-4056	1	Bolt, Hex Flange, M10 x 110mm	30 ft-lbs
2	36-4015	1	Bolt, Hex Flange, M10 x 75mm	30 ft-lbs
3	36-1531	1	Bolt, Hex Flange, M8 x 35mm	18 ft-lbs
4	82-0123	2	Washer, M10	N/A
5	82-0120	1	Washer, M8	N/A
6	38-0281	1	Idler Boss, M10	N/A
7	38-0282	1	Idler Boss, M8	N/A



1



2



3



4



5



6



7

BAG #2 - INTERCOOLER HARDWARE				
Item	P/N	QTY.	Description	Torque Spec
1	46-2155	8	Hose Clamp, 3/4"	
2	36-1552	6	Bolt, Hex Flange, M6 x 10mm	
3	36-1507	1	Bolt, Hex Flange, M6 x 16mm	
4	12-3032	2	Spacer, .625" OD x .250"	
5	12-3034	2	Spacer, M12 x 10mm	



1



2



3



4



5

BAG #3 - MANIFOLD/RUNNER HARDWARE				
Item	P/N	QTY.	Description	Torque Spec
1	36-4053	12	Bolt, Hex Flange, M6 x 40mm	8 ft-lbs
2	36-1516	1	Bolt, Hex Flange, M6 x 20mm	8 ft-lbs



1

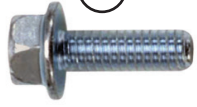

2

BAG #4 - AIR INTAKE HARDWARE				
Item	P/N	QTY.	Description	Torque Spec
1	46-2164	2	Hose Clamp, 5/8"	
2	51-4292	1	O-Ring, 2-154	



1

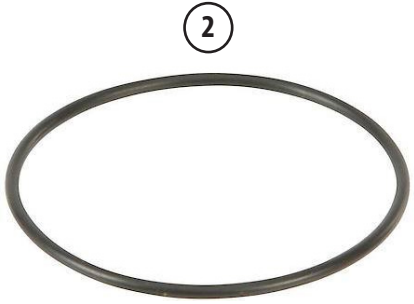

2

BRACKET IDENTIFICATION GUIDE

(Parts Are Not To Scale)

SUV LTR BRACKETS				
Item	P/N	QTY.	Description	Torque Spec
1	38-0279	1	Upper / Passenger LTR Bracket	N/A
2	38-0278	1	Upper / Driver LTR Bracket	N/A
3	38-3506	1	Lower / Passenger LTR Bracket	N/A
4	38-3505	1	Lower / Driver LTR Bracket	N/A
5	38-0276	1	Bracket, Surge Tank	N/A
6	38-0227	1	Bracket, Water Pump	N/A



HOSE IDENTIFICATION GUIDE
(Parts Are Not To Scale)

AIR INTAKE AND INTERCOOLER HOSES			
Item	P/N	QTY.	Description
1	22-1632	1	Hose, Driver Side PCV
2	56-1650	1	31" Hose, Passenger Side PCV 5/8"
3	56-0026	1	Surge Tank to Water Pump
4	56-0027	1	Water Pump to LTR
5	56-0028	1	LTR to Intercooler
6	56-1527	1	3.25" Hose, Surge Tank to Intercooler

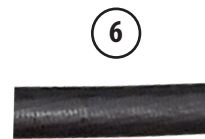

WIRE HARNESS GUIDE
(Parts Are Not To Scale)

WIRE HARNESS			
Item	P/N	QTY.	Description
1	37-3609	1	Water Pump Harness
2	37-1599	1	ETC Extension Harness
3	37-1046	1	TMAP/LIN Bridge Harness
4	37-1021	1	MAP Sensor Harness Extension

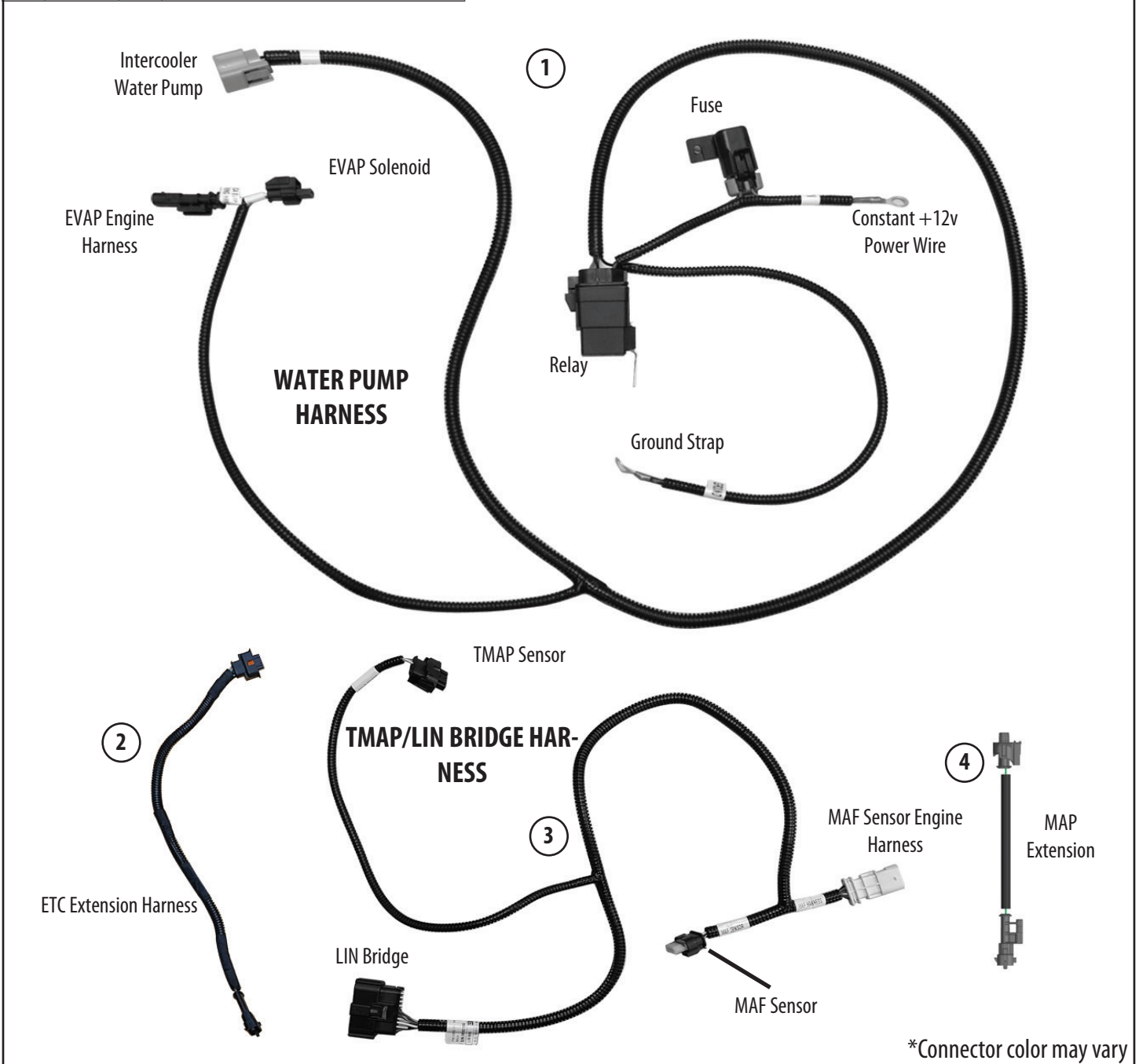

LTR BRACKET & HOSE ROUTING DIAGRAM

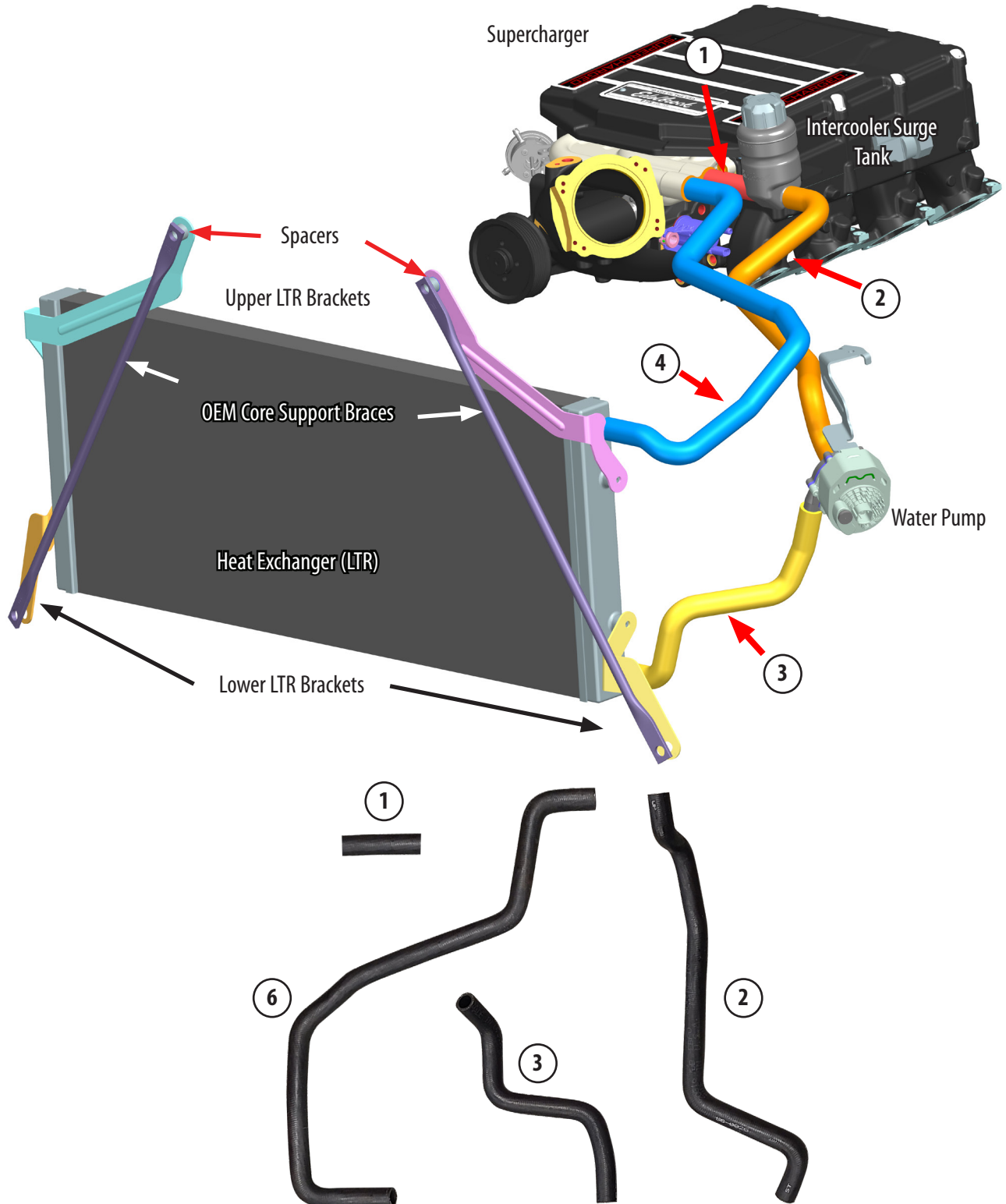

ECU REFLASH PROCESS

ECU Reflash Process

NOTE: Do the steps to send in the ECU for reflash BEFORE starting the Supercharger Installation. The ECM exchange process will take 5-8 business days.

1. Contact calibration@edelbrock.com with your name, address, phone number, VIN, Supercharger part number (e.g. 15665 or 15666) and Supercharger serial number to receive your UPS return label as soon as possible. The serial number is hand stamped on the back top left of the housing. Do NOT remove the ECM until confirmation is received from Edelbrock.
2. Disconnect the negative cable from the battery.

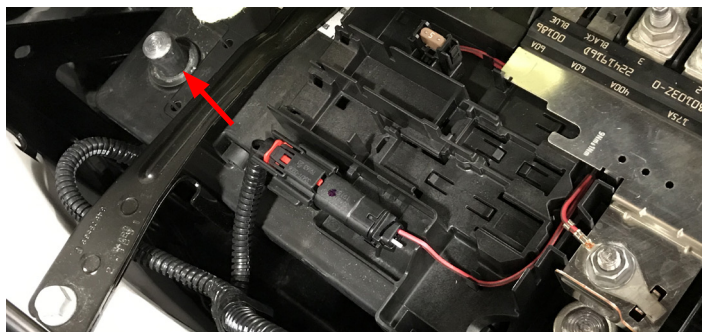

3. Remove inner fender cover from the front drive side wheel well. Remove the stock ECM from the front driver side wheel well.



4. Fill out the attached ECU information label being sure to hand write in the supercharger serial number. Apply the label to the ECU, without covering the original GM labels on the ECU.

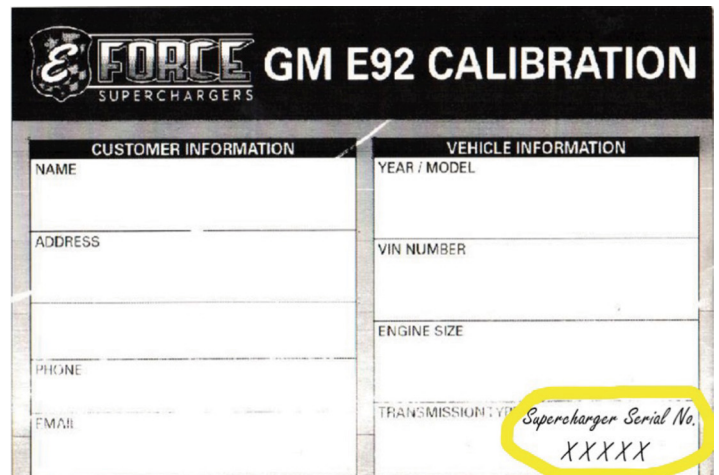

e-FORCE GM E92 CALIBRATION SUPERCHARGERS	
CUSTOMER INFORMATION	VEHICLE INFORMATION
NAME	YEAR / MODEL
ADDRESS	VIN NUMBER
PHONE	ENGINE SIZE
EMAIL	TRANSMISSION TYPE
	Supercharger Serial No. XXXXXX

5. Use the enclosed shipping box included in the Supercharger kit and insert the ECU with the label from the previous steps. Seal the box and apply the UPS shipping label from Edelbrock, then arrange for a UPS pickup. Ship to Trifecta Performance Inc. via the enclosed packaging and emailed UPS return label. The ECM exchange process will take 5-8 business days.
6. Once the ECU has been returned, it is acceptable to reinstall the ECU and start with the rest of the supercharger installation.

SUPERCHARGER INSTALLATION

NOTE: Fascia removal will vary between models and trim levels.

1. Using a 10mm socket, disconnect the negative battery terminal.

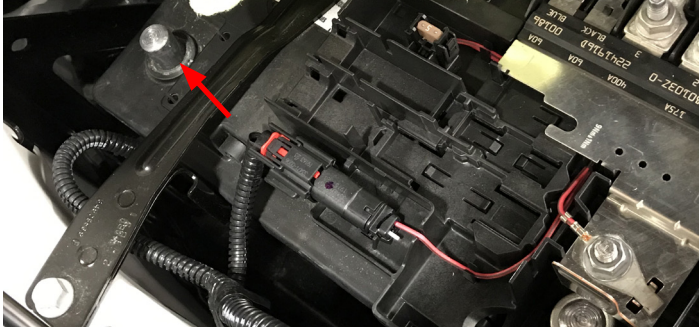

2. Using a T15, remove the 2 screws on the hood release handle. Remove handle.



3. Remove 10 clips holding the upper radiator cowl in place. Remove cowl.

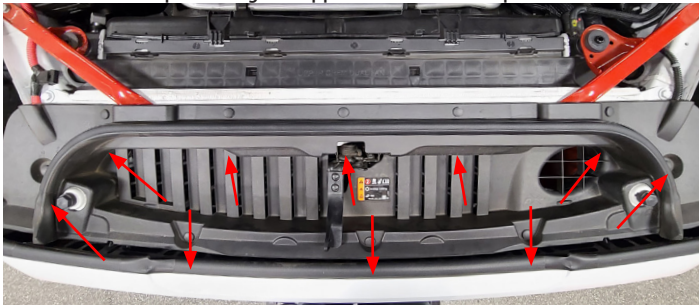

4. Remove (4) 10mm bolts from top of grill.

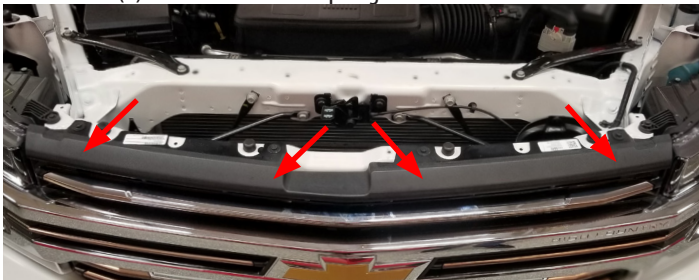

5. Carefully pull grille forward. Pay attention to these grille clip points when pulling.

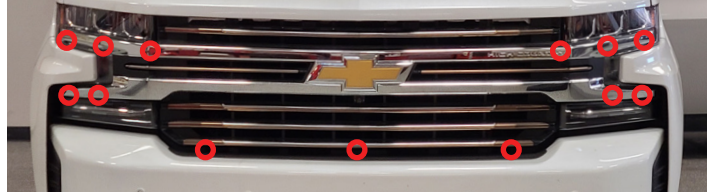

6. Using a 10mm socket, remove (9) bolts attaching the shutters to the core support. Unplug shutter control harness. Unplug and remove the shutter assembly.

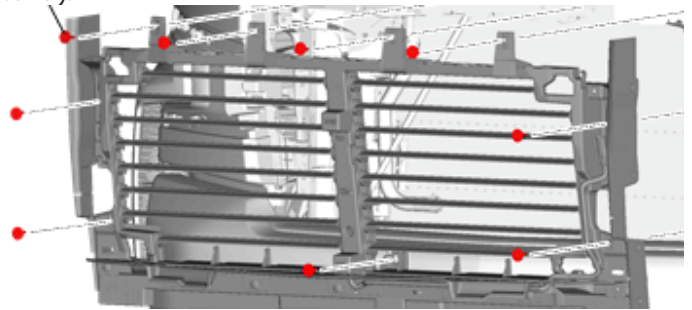

7. Unplug the horn. Use a 10mm socket to remove the horn bracket.

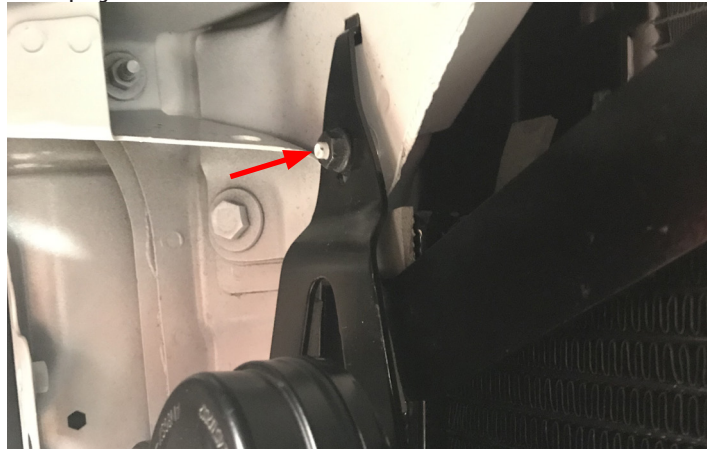

8. Remove (2) cross support bars using a 15mm socket. Set aside. These will be reused.

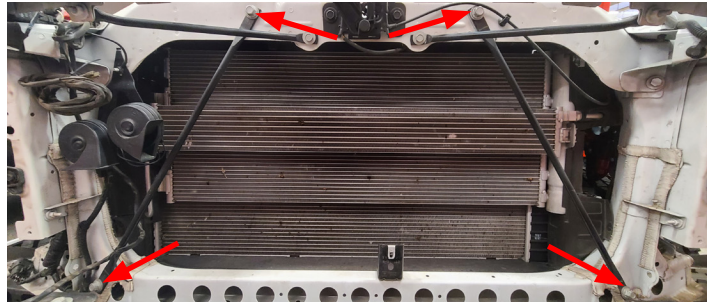

9. Remove (1) clip holding the snorkel and pull out.



10. Detach the wire harness from the two tabs located on the top of the intake manifold. Unplug the throttle body and use a 10mm socket to remove (4) bolts holding the throttle body to the intake manifold. Disconnect MAP, EVAP connections and disconnect hoses.

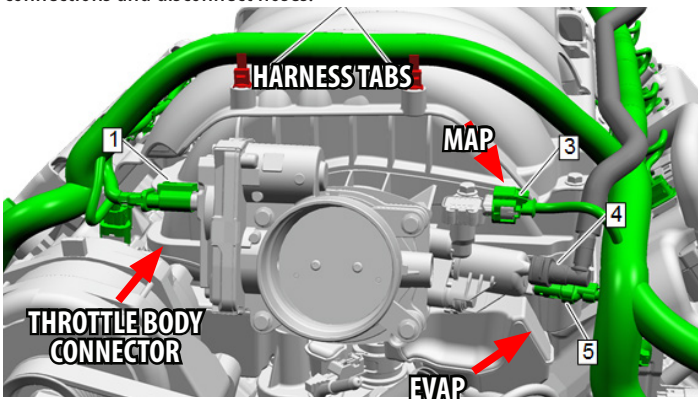

11. Remove (2) hose clamps and (1) PCV hose from the intake tube and remove.

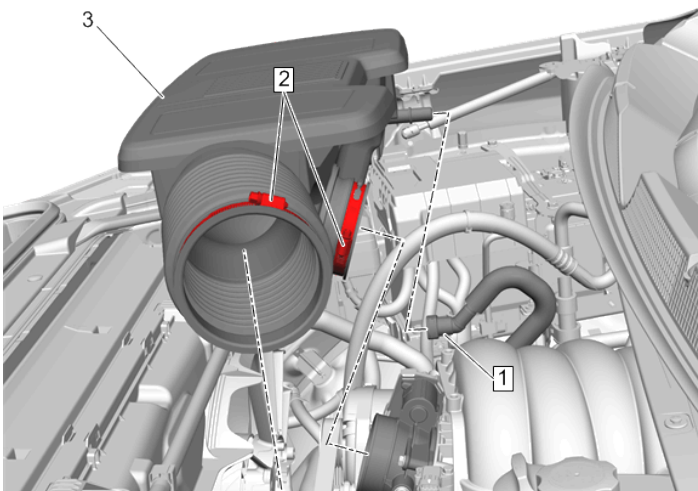

12. Disconnect the (3) harness retainers from the driver's side of the engine.

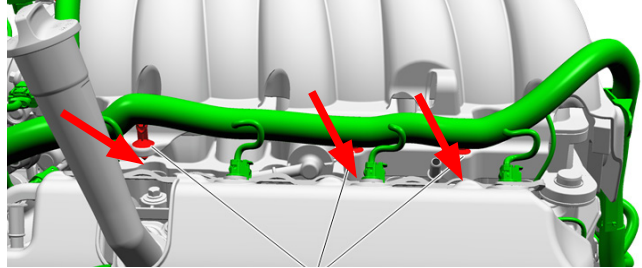

13. Disconnect the (4) harness retainers from the passenger's side of the engine.

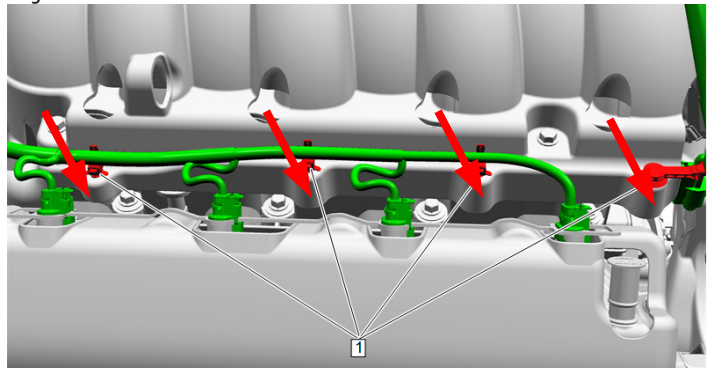

14. Using a 10mm socket, remove ten (10) bolts securing the intake manifold to the cylinder heads.



15. Pull the intake out to access the (3) rear harness retainers and detach harness from rear of intake.

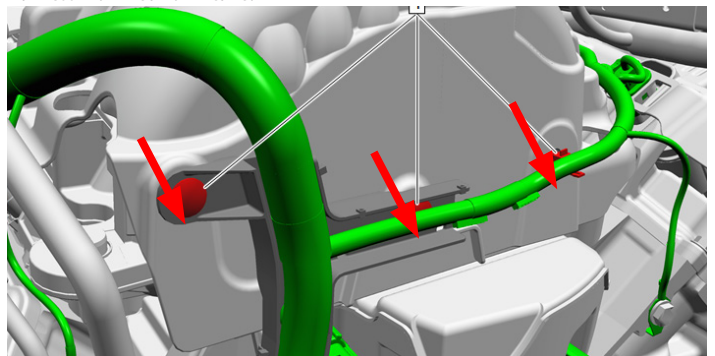

16. Remove the foam insulation from the valley cover and discard. Clean the intake port surfaces with a shop rag. Cover the ports with protective tape to keep out debris.

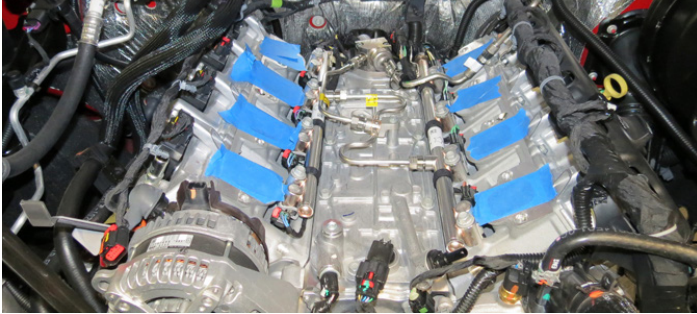

17. Cut or remove the accessory belt. It will not be reused.



18. Disconnect all plugs and cable to the alternator. Remove the inner alternator bolt and discard. Loosen the outermost alternator bolt and swing out towards the passenger side of the engine.

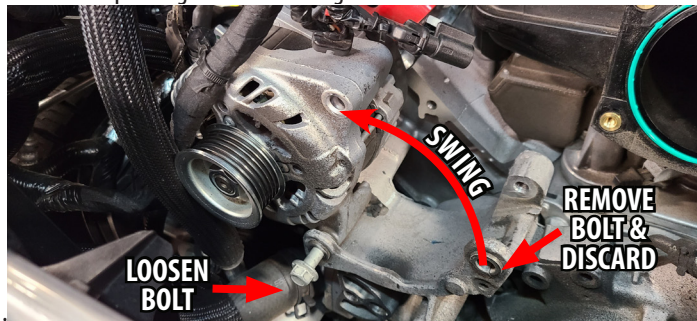

19. Remove the O-ring gaskets from the factory intake manifold.



20. Clean and inspect the O-ring gaskets and replace torn or damage O-rings as needed. Using a razor blade, or equivalent, remove the tips off all eight (8) factory O-ring gaskets.

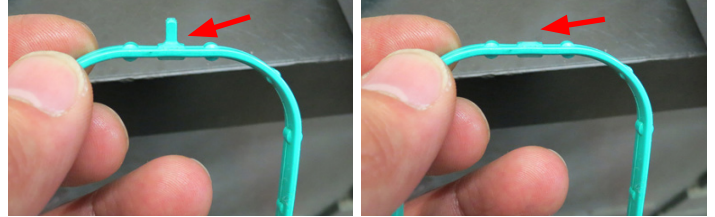

21. Install the eight (8) modified O-ring gaskets onto the runners.

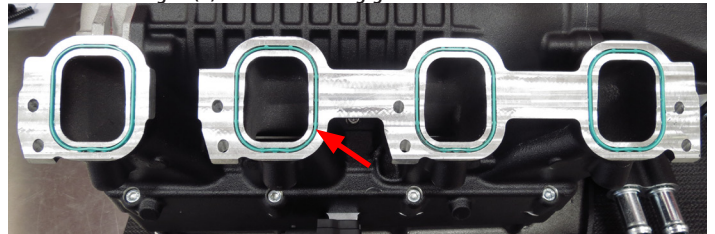

Remove the protective tape from the cylinder head. With the help from an assistant, carefully lower the supercharger into the vehicle with the original harness underneath the supercharger nose. A notch is located on the supercharger nose to clear the factory harness. (Red circle) (**NOTE: Do not hold onto the bypass actuator when lowering the supercharger onto the engine**). Align the manifold to the engine before proceeding.

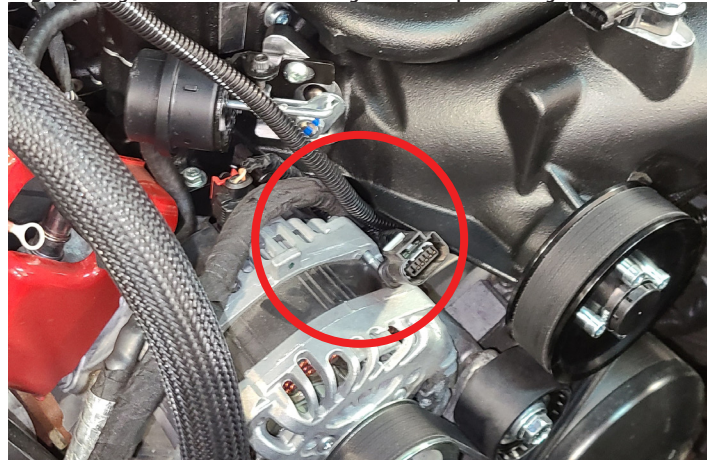

22. Apply Blue thread locker to the eight (8) M6 x 40mm hex flange bolts from Bag #3. Using a 10mm socket, secure the manifold to the engine using the torque sequence below. Torque bolts to 4 ft-lbs and then to 8 ft-lbs. **NOTE:** A short swivel-head 10mm socket is highly recommended.

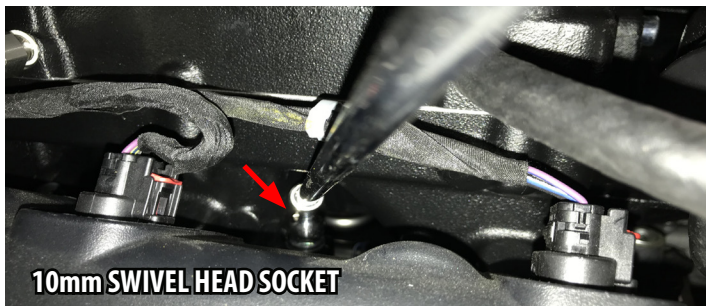
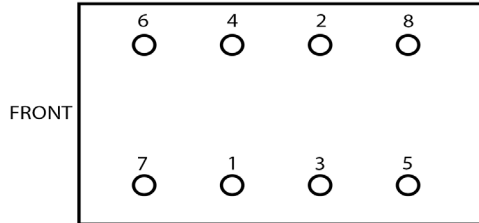

23. Using O-ring lube, install the provided O-ring into the supercharger inlet.



24. Reinstall the throttle body using the provided (4) M6 x 40mm bolts. Check to make sure the throttle body is in the correct orientation.

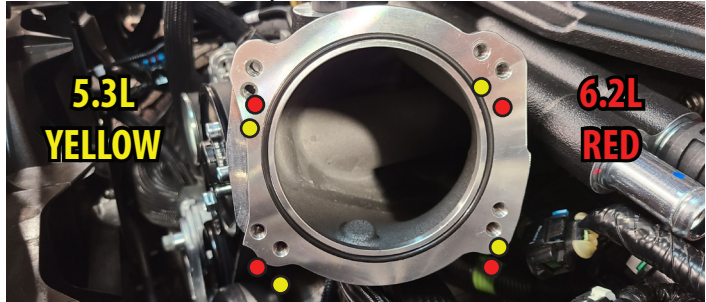

25. Using a 15mm socket, remove the bolt holding the idler to the tensioner. This smooth idler will be reused later in the installation.



26. Using the same bolt removed in the previous step, apply Red loctite to the bolt, and install the supplied grooved idler pulley to the tensioner using the supplied M8 washer.

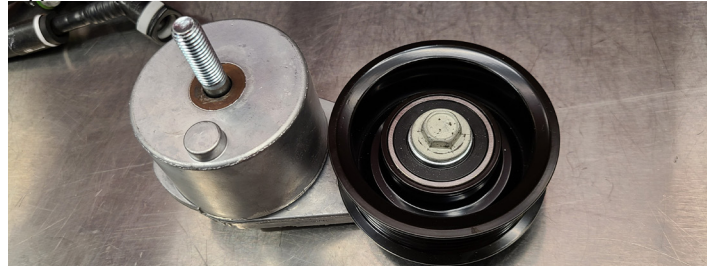

27. Using a 15mm socket, install the tensioner using the supplied 75mm bolt and a M10 washer.

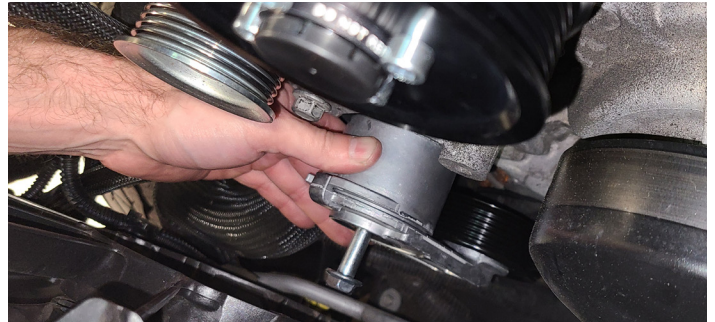

28. Place the M10 x 110mm bolt, M10 washer into the smooth idler provided in this kit. Place the M10 aluminum boss onto the opposite side as pictured below.

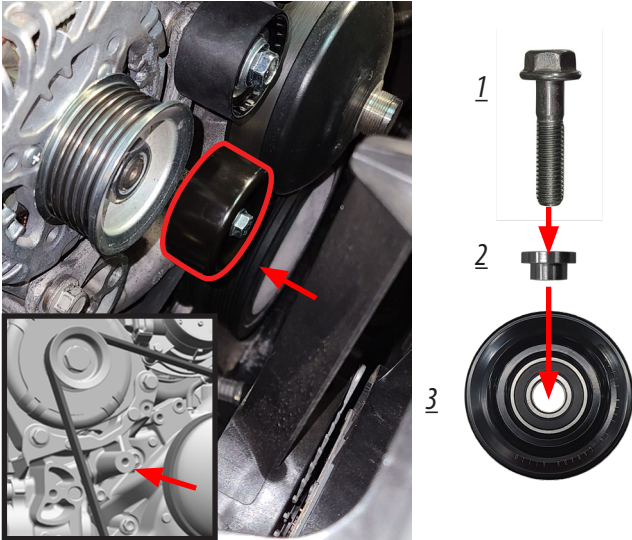

29. Place the M10 x 110mm bolt, 22mm OD washer into the smooth idler provided in this kit. Place the M10 aluminum boss onto the opposite side as pictured below.

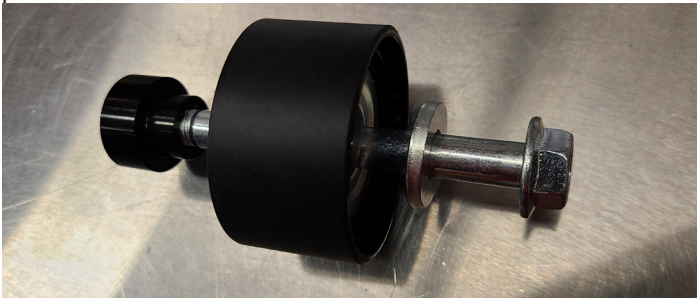

30. Swing alternator back into position. Install idler and 110mm bolt assembly into the alternator mount using Blue Loctite. This bolt will replace the one that was removed earlier in this install.

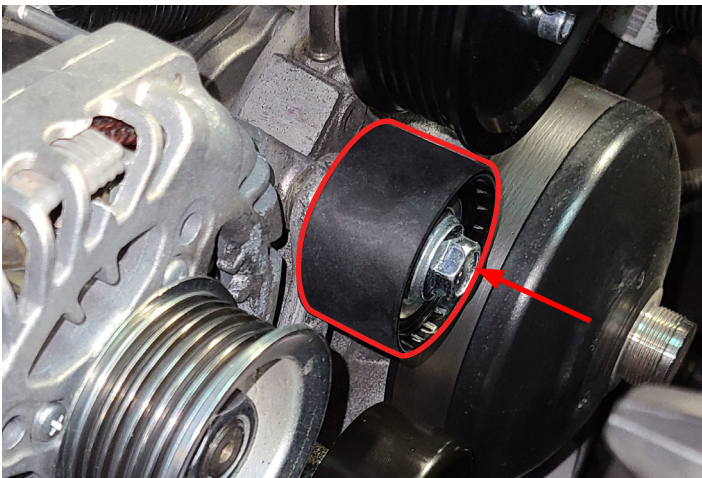

31. Using a 15mm socket, remove the vestigial grooved idler on the driver's side of the engine. Or you may leave it installed. In either case it will no longer be used.

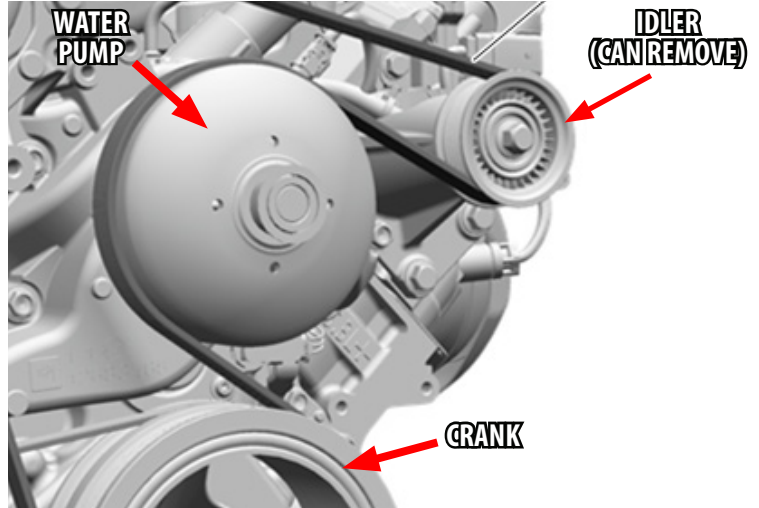

32. Install the provided belt.

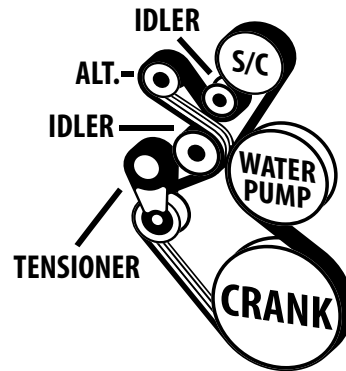

33. Using a sharp razor, carefully cut the hoses to remove the factory fittings from the passenger side PCV hose.



34. Install the fittings onto the provided 31" x 5/8" hose using hose clamps.



35. Install the hose assembly onto the passenger side PCV port located on the valve cover.

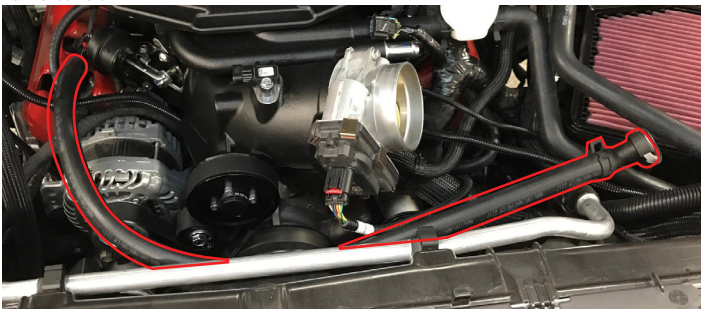

36. Place hose clamps inboard of all hose ends. Install hoses onto the LTR as pictured. Coolant ports should face the driver side with ports positioned towards the rear. **NOTE:** Position hose clamp tabs so they face the rear of the vehicle as to clear the LTR brackets.

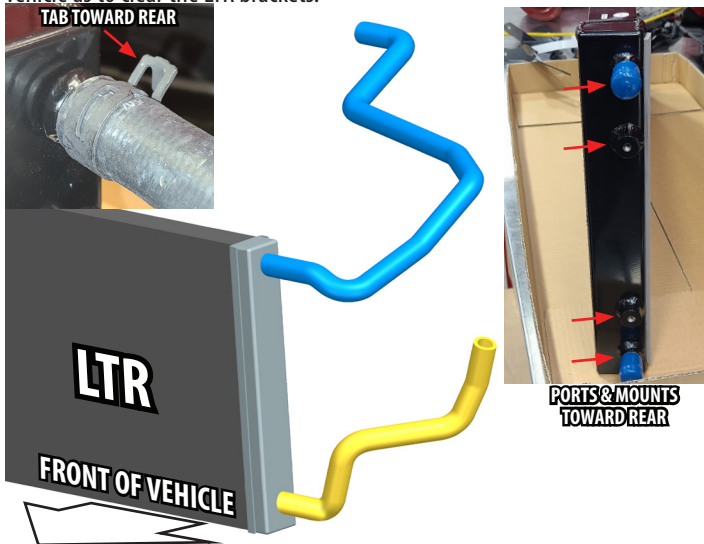

37. Feed LTR hoses through the gap in the core support located on the driver's side of the radiator. **NOTE:** Protect the LTR from damage from the lower center shutter support

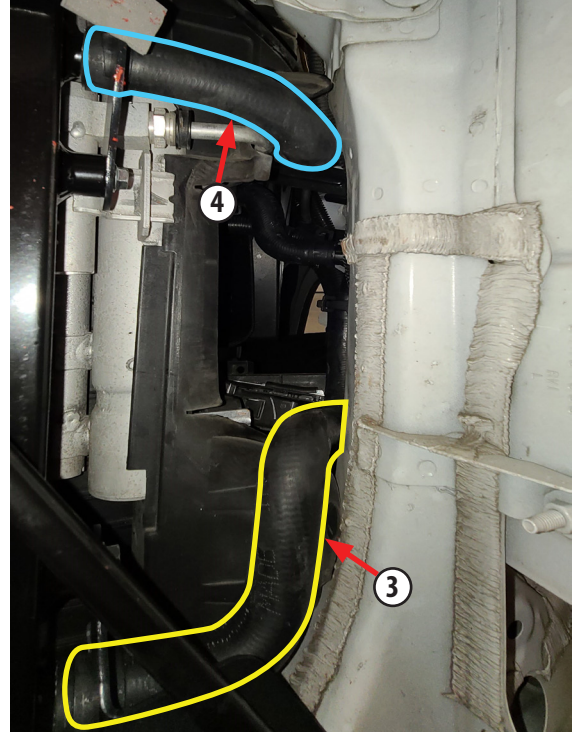

38. Place rubber isolator onto pump as shown below.

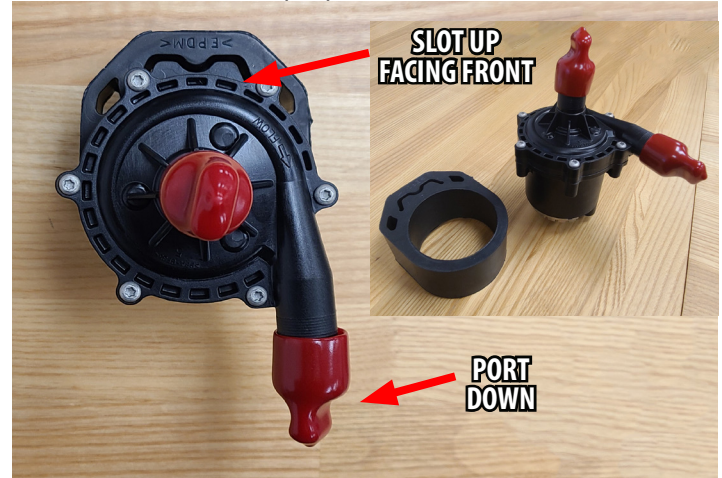

39. Install the pump assembly onto the lower LTR hose and clamp with previously installed hose clamp. Next, remove the nut holding the lower airbox to the fender support. Install the Water Pump bracket to the airbox stud and slide the water pump and isolator onto the bracket. Reuse the factory nut to secure the bracket. Tip: It is easier to get the water pump into position behind the headlight before inserting the bracket.

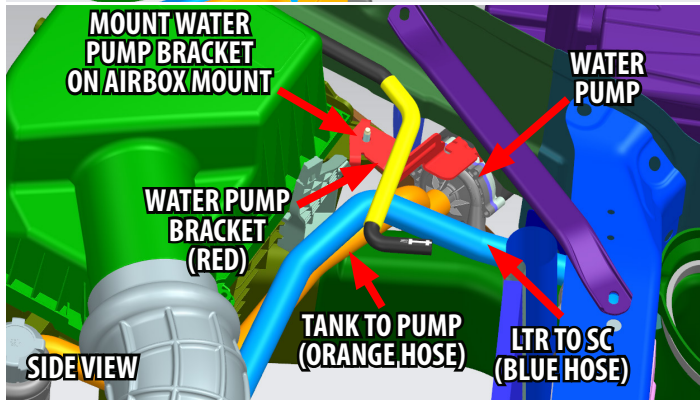
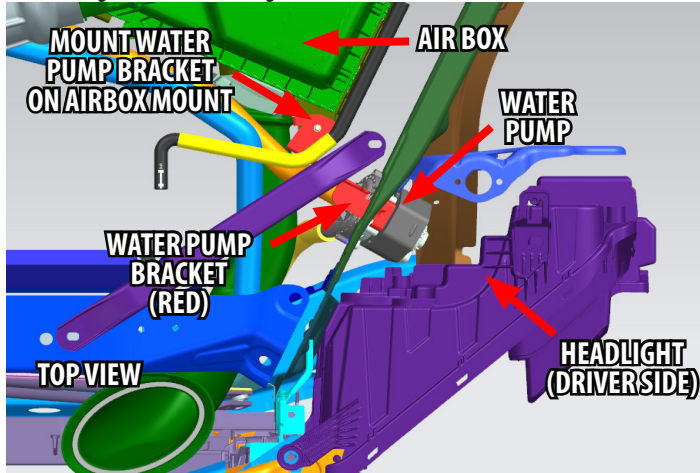

40. Install EVAP and connect the supplied EVAP/Water Pump harness. Plug the OEM EVAP plug into the harness and connect original EVAP hose. Install the provided driver side PCV hose from the valve cover to the PCV port in the supercharger nose.



41. Assemble the surge tank using hardware bag #2.

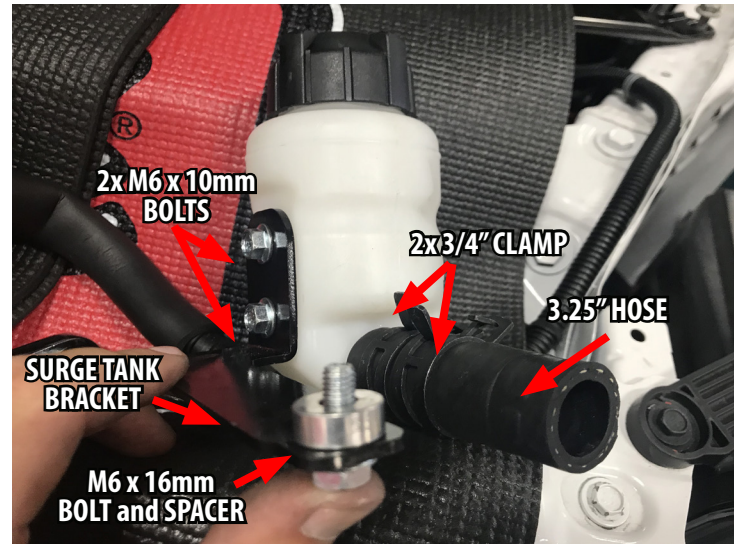

42. Install the surge tank assembly to the rearward port on the supercharger. Bolt the bracket underneath the supercharger lid.

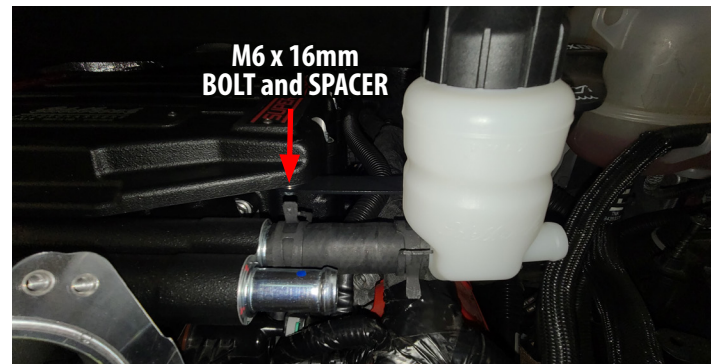

43. Connect the rest of the hoses as shown with clamps.

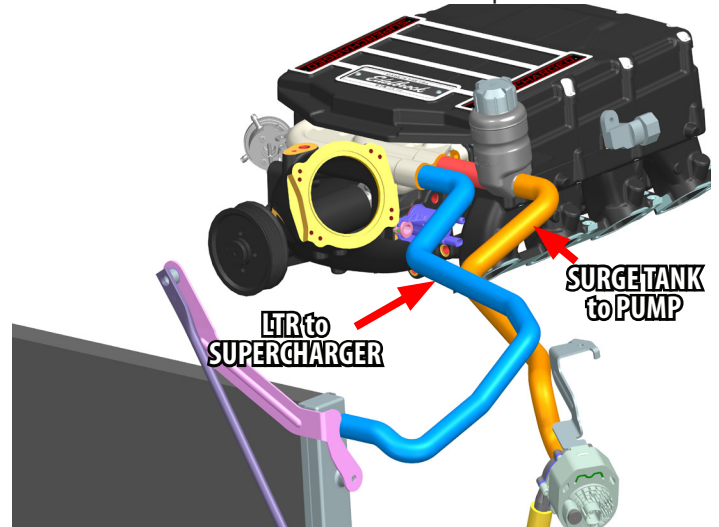

44. Using (4) M6 x 10mm bolts, install the LTR brackets to the LTR as shown.

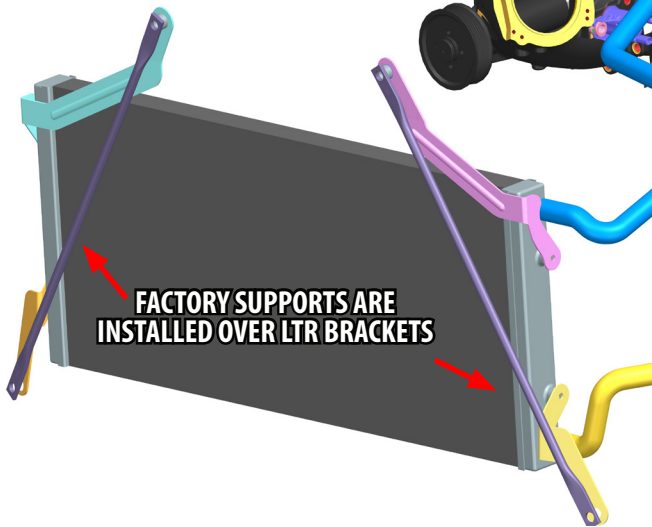

45. Using the factory bolts, reinstall the factory core support braces over the LTR brackets. Be sure to add the M12 spacers between the upper LTR brackets and core support brace.

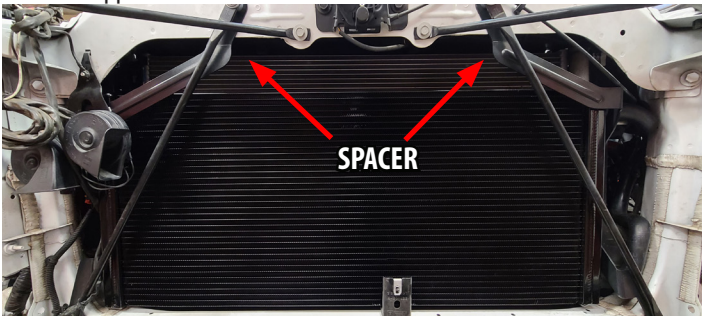

46. Remove the MAP sensor from the factory intake manifold and mount it the supercharger nose using the provided M6 x 20mm bolt. Connect the MAP Extension harness to the MAP and connect the plug to the original MAP connector.



47. Route the MAP extension harness (previously installed) over to the MAP

sensor. Be sure the cable isn't binding.

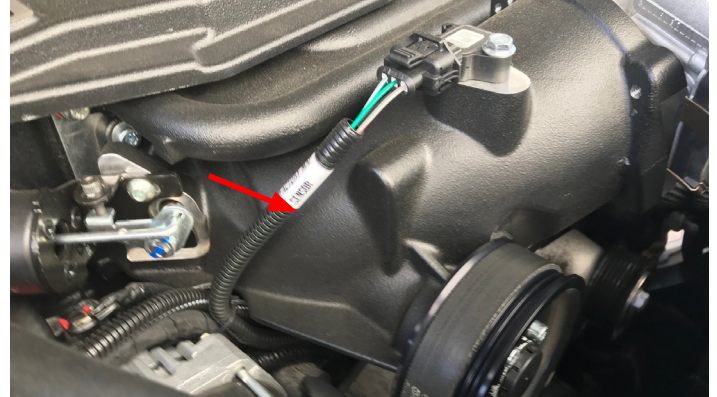

48. Insert the provided K&N Air Filter at this time.



49. Install intake tube using the provided hose clamps and connect the passenger side PCV.

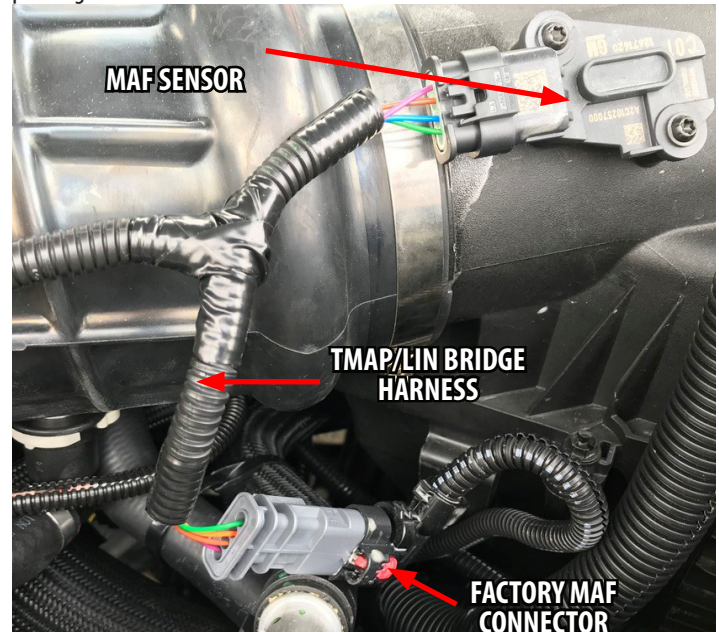

50. Install intake tube using the provided hose clamps and connect the passenger side PCV.



51. Connect the TMAP\LIN BRIDGE harness to the TMAP sensor located on the driver side of the manifold.



52. Connect the Water Pump Harness to the water pump.

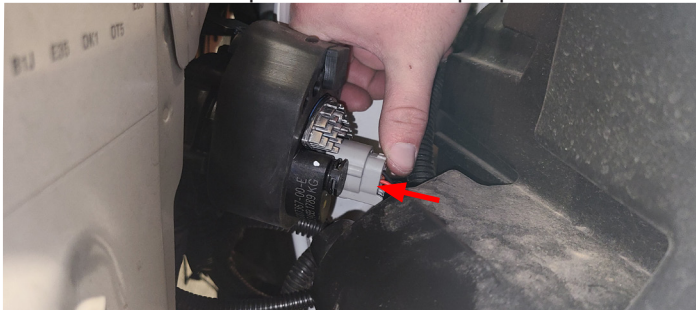

53. Connect the Water Pump Harness 12V positive lead to the 12V positive post located here. Double check that EVAP trigger connectors are connected.



54. Fasten the ground lead underneath the ground post located on the passenger side fender near the hood shock. Secure wiring away from pulleys.



55. Place LIN Bridge behind air filter box and insert connector from harness. Secure in place with double-sided foam tape. **WARNING: DO NOT PLACE THE LIN BRIDGE OVER ANY EXISTING LABELS**



56. Place supplied spacer from hardware bag #2 onto horn mount stud as shown. Reinstall the horn assembly and fasten using the factory nut. Connect horn harness at this time.

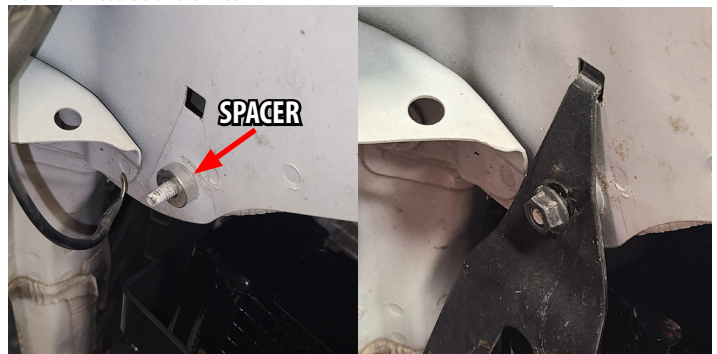



Edelbrock Supercharger System
2019-2021 GM Truck 1500
2020-2021 GM SUV 1500
5.3L and 6.2L Installation Instructions

57. Reconnect batter and all other connections. Reinstall front fascia in the reverse order of removal.



Congratulations on the successful installation of your new Edelbrock E-Force Supercharger System. If you have any questions, please call our Technical Support hotline at 800-416-8628 and one of our technicians will be happy to assist you.

CAUTION: Check ADAS sensors as described under the “Important Warning” section in the beginning of this document.

58. Fill the surge tank with a 50/50 mixture of coolant and distilled water. Reconnect the battery and key on the accessory power vehicle and listen for the pump. Pump will automatically shut off if no coolant is flowing through the pump. Check all connections for leaks. Read the guide on the last page on filling the supercharger cooling system. Check the system for leaks before reinstalling the front fascia.



59. Disable the Air Filter Life Display.

* Display the Air Filter Life on the Driver Information Center (Dashboard display).

* On the steering wheel Press > to move to the Reset/Disable display area.

Select “Disable” and then press the √.

* Press √ to confirm the disable.

60. Install the CARB EO Label: WARNING: This label is required to aid inspection of the vehicle under the California Smog Check program. Prep the surface that the label will be affixed to with isopropyl alcohol. Peel the label off of the backing sheet and place in an under hood location near the Vehicle Emissions Control Information Label.

61. Install the 91 Minimum Octane Label: Prep the surface that the label will be affixed to with isopropyl alcohol. Peel the label off of the backing sheet and place inside of the fuel door.

WARNING: This label is required to aid inspections of the vehicle under the California Smog Check Program



How to Prime the Edelbrock E-Force Intercooler Systems.



The electric water pump used on this Edelbrock E-Force Supercharger System has a built-in micro-processor that will vary pump cycle speed when air bubbles are present in the system. If a significant amount of air is trapped in the system, the pump may cycle at a slower speed and pulsations are likely to occur resulting in poor cooling performance.

For the best result, it is highly recommended to use a Radiator Cooling System Vacuum Purge and Refill Kit to properly evacuate the air from the intercooler system before filling with a 50/50 mixture of coolant and distilled water. If one is not available, the following procedure will be adequate.

1. Using the Lisle 24680 Spill-Free Funnel, or equivalent, secure the appropriate filler neck adapter to the surge tank.
2. Attach the funnel and fill with a 50/50 mixture of coolant and distilled water until the funnel is half full.
3. Turn the ignition to the ON position and listen for the pump's electric motor to cycle. Air bubbles will begin to purge from the system as the coolant level drops. Add coolant to the funnel as necessary. *NOTE: Do NOT let the coolant level in the funnel run empty as this may introduce air into the system.*
4. To build more pressure in the intercooler system, try squeezing the intercooler hoses while the pump is cycling. Building pressure in the system will help purge the trapped air from the intercooler system.
5. Cycle the ignition OFF and wait a few seconds for the pump to come to a stop.
6. Cycle the ignition ON again and repeat until the sound of the electric pump is continuous without any pulsation. *NOTE: During water pump start-up, it is normal for a slight pulsation to occur. Once the pump has reached its maximum cycle speed, no pulsations should be present.*
7. Periodically inspect the water pump flow after a few drive cycles and re-fill the intercooler system as necessary.
8. Several drive cycles may be required to completely purge the air from the intercooler system. During a drive cycle, the intercooler system will build up pressure as the supercharger temperature increases. Any residual air trapped in the system will gradually bleed out of the surge tank as the system reaches a pressure above 5psi.

WARNING: Always avoid removing the surge tank cap when the engine is hot. The hot coolant is under pressure and may spray out causing burns.