

MAGNUSON

SUPERCHARGERS

Installation Instructions for: Intercooled Supercharger System 2009-2014 CTS-V and 2012-2015 ZL1 Camaro



Step-by-step instructions for installing the best in supercharger systems.

*** PREMIUM GASOLINE FUEL REQUIRED ***

ATTENTION!

Your **MAGNUSON SUPERCHARGER** kit is sensitive to corrosion!

Use only the vehicle manufacturer recommended coolant for your engine in the intercooler system as well.



Magnuson Superchargers
1990 Knoll Drive, Bldg A, Ventura, CA. 93003
(805) 642-8833
magnusonsuperchargers.com

INSTALLATION MANUAL

Magnuson Superchargers Magnum DI
Intercooled Supercharger System
GM LSA Engines

Please take a few moments to review this manual thoroughly before you begin work: Make a quick parts check to be certain your kit is complete (see shipper parts list in this package). If you discover shipping damage or shortage, please call your dealer immediately. Take a look at exactly what you are going to need in terms of tools, time, and experience. Review our limited warranty with care. When unpacking the supercharger kit **DO NOT** lift the supercharger assembly by the black plastic bypass actuator. This is pre-set from the factory and can be altered if used as a lifting point!

Caution: Relieve the fuel system pressure before servicing fuel system components in order to reduce the risk of fire and personal injury. After relieving the system pressure, a small amount of fuel may be released when servicing the fuel lines or connections. In order to reduce the risk of personal injury, cover the regulator and fuel line fittings with a shop towel before disconnecting. This will catch any fuel that may leak out. Place the towel in an approved container when the job is complete.

This supercharger system requires the use of only premium gasoline fuel, 91 octane or better. It is NOT compatible with E85, Ethanol, or Flex fuels.

Magnuson Superchargers recommend that you run a minimum of one (1) tank of premium fuel through your vehicle prior to installation of the system to prevent any possible damage that may occur due to running the supercharged engine on lower octane fuel. **DO NOT add octane booster to your vehicle.**

Magnuson Superchargers systems are designed for engines and vehicles in “GOOD” mechanical condition. Magnuson Superchargers recommend that a basic engine system “Health Check” be performed prior to the installation of this supercharger system. Be sure to check for any pending or actual OBDII codes and fix/repair any of the stock systems/components causing these codes. If there are codes prior to the installation they will be there after the installation.

Magnuson Superchargers also recommend the following services to be performed on your vehicle before starting and running the vehicle post supercharger system installation:

- Fuel and Air Filter change
 - Engine oil and oil filter change using the vehicle manufacturer’s specified products
- NOTE: It is VERY IMPORTANT to use the factory specified oil viscosity. The original equipment manufacturer has selected this grade of oil to work with your other engine systems such as hydraulic chain tensioners and variable cam controls. Deviation from this specification may cause these systems to fail or not function properly. Please refer to your owner’s manual for the recommended oil viscosity for your engine and application.
- On newer vehicles not requiring new spark plugs it is important to verify the spark plug air gap.

On older vehicles Magnuson Superchargers recommend these additional services to be performed:

- New spark plugs with the air gap set at the factory specifications OR new specifications if required by the installation manual.
- Engine coolant system pressure test, flush and refill.
NOTE: YOU MUST USE THE GM SPECIFIED COOLANT MIXTURE!
- Non “Magnuson Approved” calibrations or “tuning” will Void ALL warranties and CARB certification.

Tools Required

- Metric wrench set
- ¼" , 3/8" and ½" drive metric socket set with a 27mm (Standard & Deep)
- 3/8" and ½" drive foot pound and inch pound torque wrenches
- Phillips and flat head screwdrivers
- 1/2" breaker bar
- Fuel line quick disconnect tools (included in kit)
- Drain pan and funnel
- Hose cutters
- Hose clamp pliers
- Safety glasses
- Small pry bar
- Metric Allen socket set 3/8" drive
- Shop vacuum cleaner

IMPORTANT

NOTES:

- 1. For the purpose of these instructions, all references to left hand side or right hand side shall be interpreted as if being seated in the driver seat of the vehicle.**
- 2. It is IMPORTANT to utilize 91 Octane gasoline or better with your supercharger system. Before starting this installation, on an empty tank, fill your tank to full with 91 Octane gasoline or better.**
- 3. Never add Octane booster to your fuel. If you have used Octane Booster in the past, replace your spark plugs and check your O2 sensors before completing your supercharger install.**
- 4. Your supercharger system is sensitive to corrosion. Use only the OEM recommended coolant mixture for your supercharger system as well as your engine.**
- 5. Please remember to follow all safety rules that apply when working, including:**
 - **Wear eye protection at all times**
 - **Do not work on a hot engine**
 - **Be careful around fuel – use shop towels to catch any spills and dispose of towels properly**

Contact Information:

Magnuson Superchargers
1990 Knoll Drive, Bldg A
Ventura, CA 93003

Sales/Technical Support Line: (805) 642-8833
Website: www.magnusonsuperchargers.com
Emails: sales@magnusonsuperchargers.com
support@magnusonsuperchargers.com

Supercharger Belt: Gates Micro-V K080660HD

NOTE TO CUSTOMERS WITH MODIFIED VEHICLES:

The Magnuson calibration included with this kit is intended to work on stock vehicle configurations, including stock trim levels and stock OEM vehicle options. Modifications to your stock vehicle including, but not limited to, engine, flywheel, clutch, torque converter, transmission, wheels, tires, axles, gears, driveshafts, induction system, exhaust system and additional weight (ie. bumpers, racks, etc.) can have a significant impact on your vehicle's calibration and may require modifications to our calibration as supplied.

While we attempt to minimize the need for modifications during our development process, it is impossible for our team to account for all possible build variations/combinations, and in some cases it may be necessary for you to supply an additional element of customization for your vehicle—custom calibration—and to work, at your own direction and expense, with a local service facility to address your unique combination of hardware and make calibration adjustments as necessary.

Please be aware that standard product warranties and governmental emissions certifications are predicated on stock vehicle configurations, and vehicle modifications and calibration changes may affect or even void powertrain warranty and emissions certification status (such as CARB emissions certification). It is the sole responsibility of the customer making a warranty claim to prove that any vehicle modifications and calibration changes were within warranty. It also is the sole responsibility of the customer to determine if the modifications and changes comply with all local, state and federal emissions standards.

Table of Contents

Section 1: Tuning Vehicle Computer and Initial Steps	6
Section 2: Factory Supercharger Removal	8
Section 3: Valley Plate Removal and Supercharger Preparation	14
Section 4: Supercharger Installation, Hoses and Electronics	21
Section 5: Coolant Fill and Final Testing	29

NOTE: For the purpose of these instructions all references to left or right side are assumed to be as indicated from the seated position in the driver seat of the vehicle.

Section 1: Tuning Vehicle Computer and Initial Steps

1. **If your kit has a provided handheld tuner follow the instructions in the provided pamphlet to install your tune. Your handheld tuner may not match the one shown.**



2. Your Intercooler system is sensitive to corrosion. It's very important to use the OEM recommended engine coolant mixture in your supercharger system as well.



3. Your system requires the use of minimum 91 Octane gasoline fuel. This system is **NOT** compatible with E85 fuel.



4. Remove both closeout trim panels on the driver and passenger side by lifting the front up.



5. Remove the supercharger engine cover by lifting at the front.



6. Open the trunk and look at the arrow location shown below to find the battery and fuse access panel. Remove the panel.



7. Remove the fuse for the fuel pump and start the vehicle and allow it to run out of fuel. (Fuse is located behind the fuse panel) Remove the screw holding the panel to access the fuses.



8. Remove the ground from the battery. Make sure to cover the ground post to keep the cable from touching it.



Section 2: Factory Supercharger Removal

9. Remove the strut brace. Use a 18mm socket to remove the nut and bolt from each side.



10. Use a ½ inch drive breaker bar at the curved yellow arrow to remove the supercharger drive belt. (Counterclockwise)



11. Remove the clean air tube from the throttle body and the airbox. Disconnect the PCV line from the tube at the blue arrow. Remove the worm drive tension using a 8mm socket at the yellow arrows.



12. Remove the radiator closeout panel. (6 push clips)

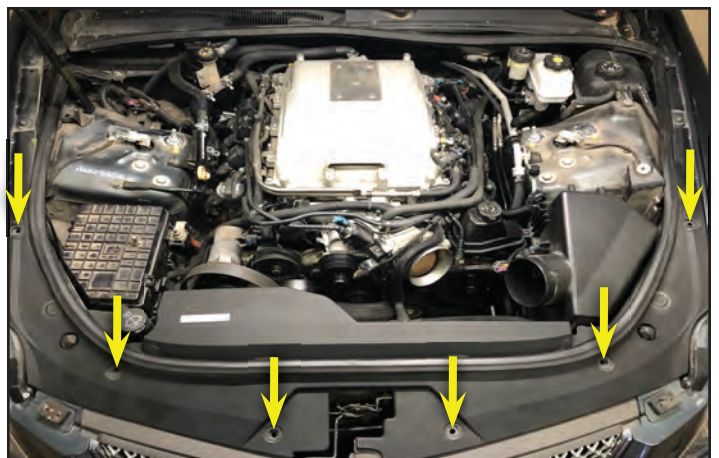

13. Unbolt the M6 bolt (10mm socket) from the airbox at the arrow location. Remove the airbox assembly from the vehicle. Install a new air filter if the current filter is dirty.



14. Remove the PCV hose from the driver side valve cover at the arrow location.



15. Remove the PCV hose from the passenger side valve cover at the arrow location.

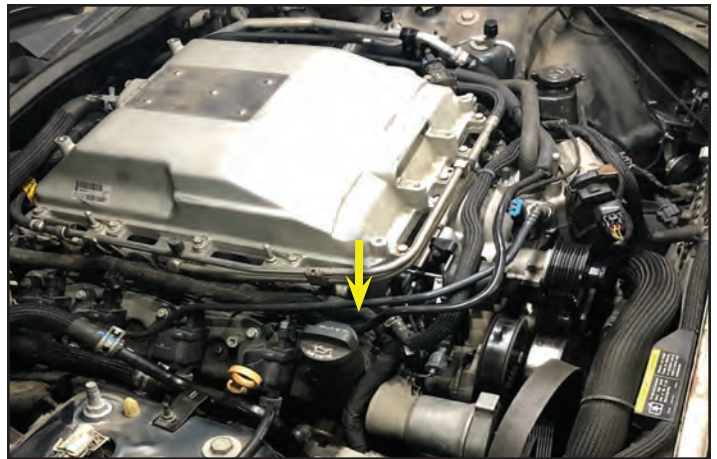

16. Remove the electrical connectors from the EVAP solenoid and throttle body.

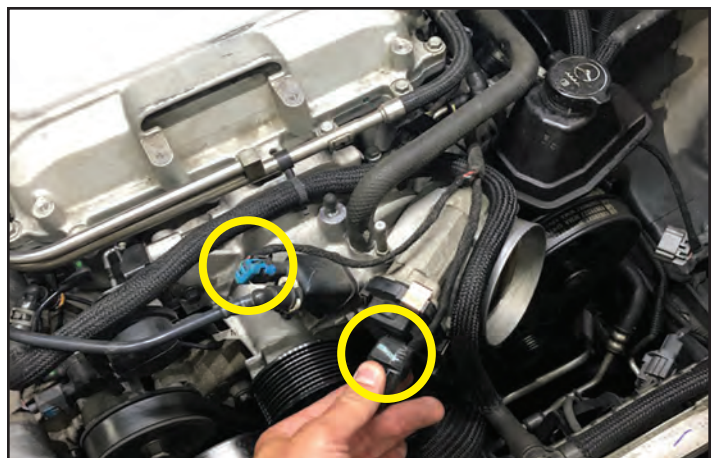

17. Remove the electrical connectors from the MAP sensor, IAT sensor and barometric pressure sensor.

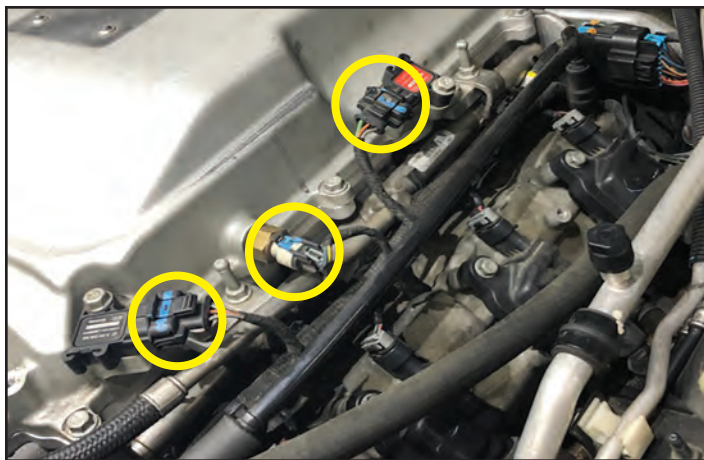

18. Remove the EVAP hose from the EVAP solenoid and the brake aspirator hose from the supercharger inlet.

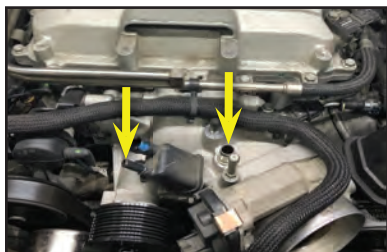

19. Remove the steam vent clamp from the fuel rail crossover.



20. Move the hose from the last step over out of the way as shown here.



21. Remove the throttle inlet pressure sensor connector.



22. Use a vacuum tool to remove the coolant from the intercooler system.



23. Remove the upper and lower charge air cooler hoses.



24. Remove the 17 supercharger lid bolts with a 10mm socket.

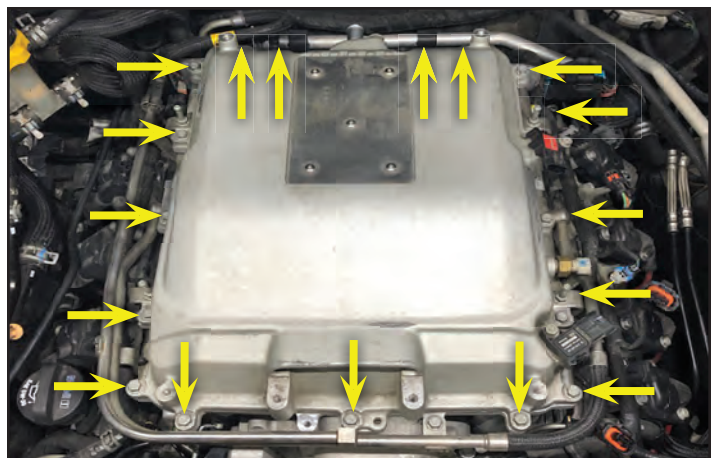

25. Remove the supercharger lid.

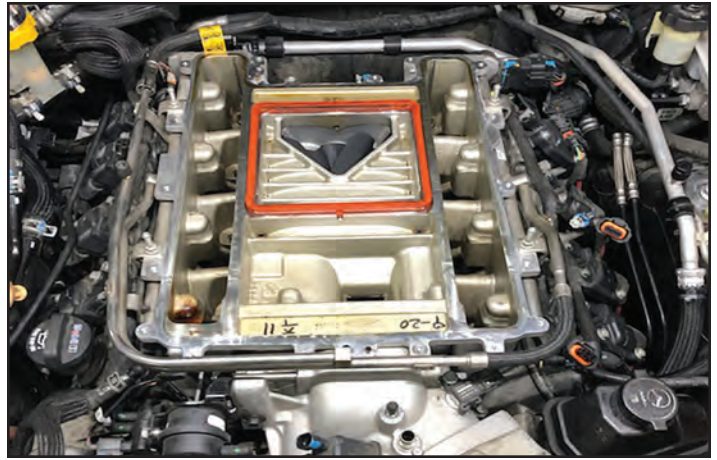

26. Remove the fuel line lock clip highlighted in green and shown with an arrow.



27. Use the provided 3/8" tool to disconnect the fuel rail. This process is discussed in the next step. Move the fuel line to the side to allow more access to the supercharger.



28. **Eye protection is necessary.** (Note: This is a Z06 fuel line but the process is the same) Place rags under the fuel line connection. Place the provided plastic tool over the fuel line at the green arrow location shown.
 A. Push the fuel supply line in towards the plastic tool.
 B. Now pull the plastic tool towards the fuel supply line.
 C. Pull on the fuel supply line to remove. Be careful while releasing the connection because fuel will spill. Properly dispose of any fuel soaked rags.

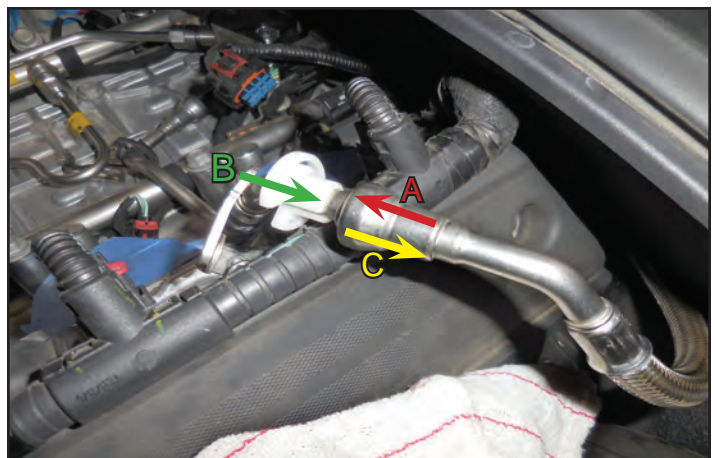

29. Disconnect the 8 fuel injector electrical connectors. Remove the clips holding the electrical harness to the rails.



30. Disconnect the 8 connectors from the coil packs (4 are shown here). Move the harness to the side to gain more room.

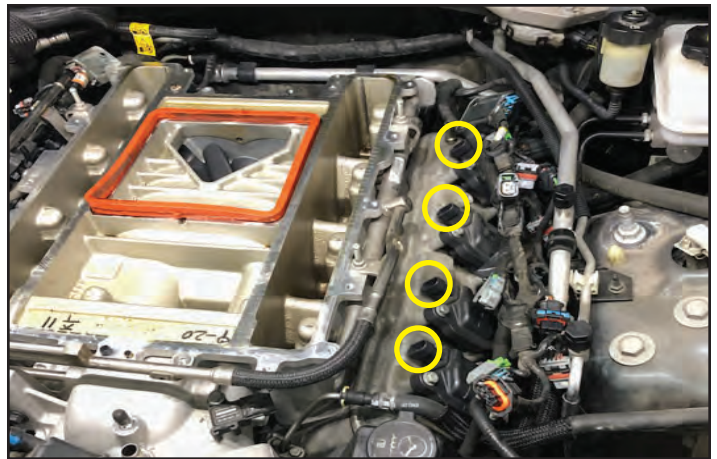

31. Remove electrical connector mount from the back of the supercharger. Use a 10 mm socket. Use a pick tool and remove the connector from the bracket. Repeat the process on the passenger side.

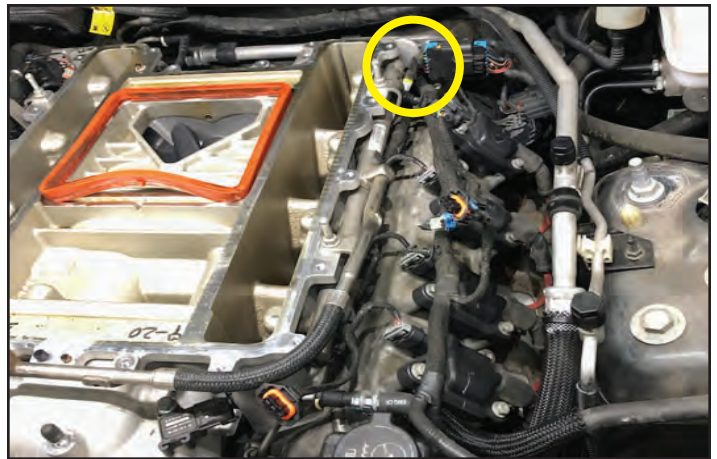

32. Remove the electrical connector from the bypass solenoid control valve.



33. Remove the 10 supercharger to head bolts with an 8mm socket.

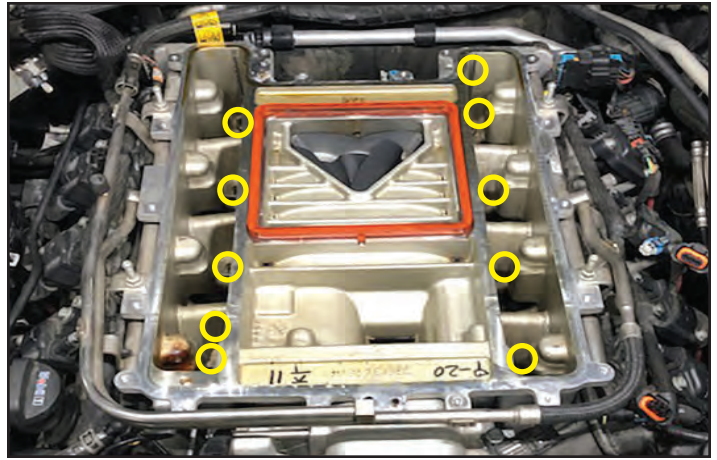

34. Lift the supercharger slightly and disconnect the PCV running to the valley plate. Remove the supercharger from the cylinder heads.



35. Clean the intake ports and tape over them to keep debris from falling in. After the intake ports are covered use a vacuum and suck up any debris on the valley plate.



Section 3: Valley Plate Removal and Supercharger Preparation

36. Disconnect the oil pressure switch from the valley plate.



37. Remove the 11 valley plate bolts with a 13 mm socket.

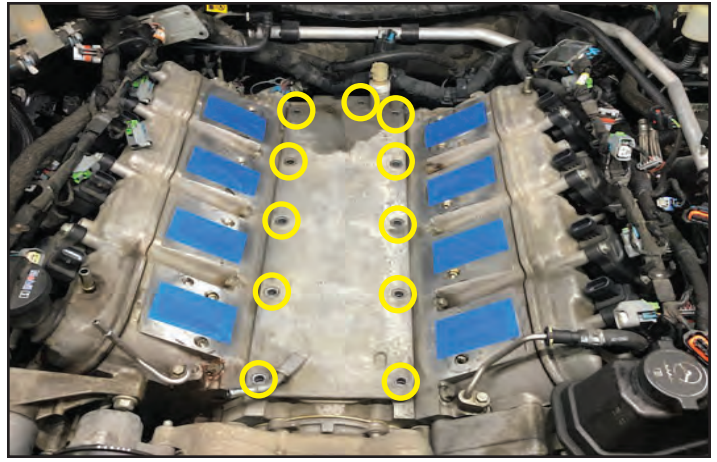

38. Clean the valley plate surface.



39. Gather the valley cover plate and install the O-rings as shown. (Use some Lubriplate grease to help with the installations of the O-rings into the groove)

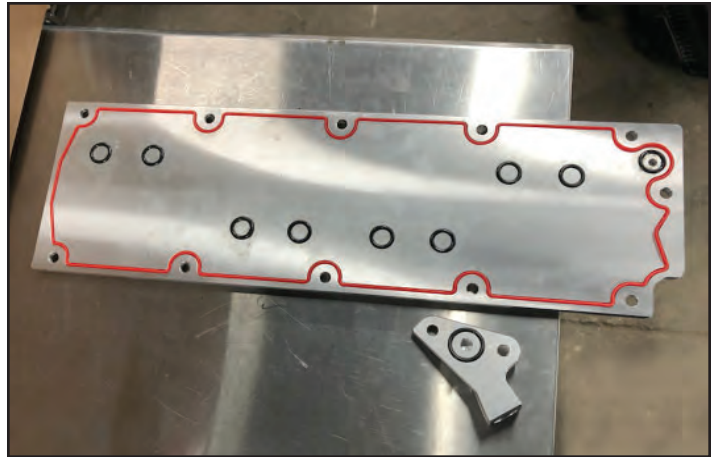

40. Install the valley plate onto the engine. Use the 2 longer bolts on the back where the oil pressure sensor mount is located. (Circled in yellow)

Torque the plate to 18 ft-lbs using a 5mm Allen head socket.



41. Gather the old valley cover and remove the oil pressure sensor using a 27mm (1-1/16") deep well socket.

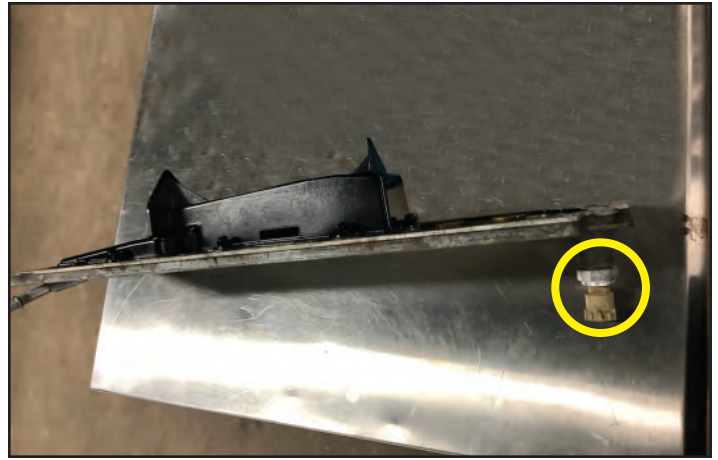

42. You may need to put some new thread sealer on the threads of the sensor. Torque the sensor to 15-24 ft-lbs. Connect the electrical connector.



43. Remove the 4 bolts holding the stock fuel rail to the stock superchargers with a deep 10mm socket.

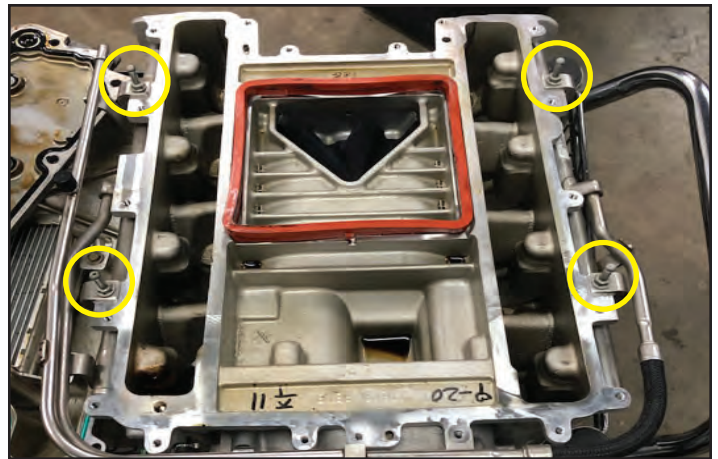

44. Remove the injectors from the clips and gather the 8 injectors from the fuel rail. Replace any damaged O-rings.

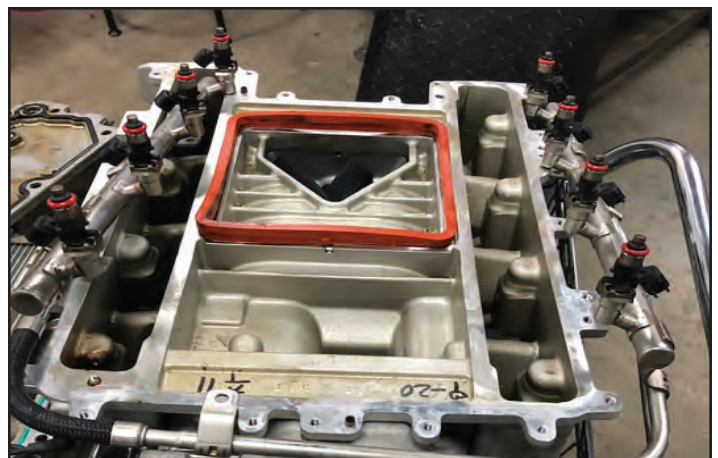

45. Use a 10mm socket to remove the 4 bolts holding the fuel rails to the new supercharger. (2 per side)

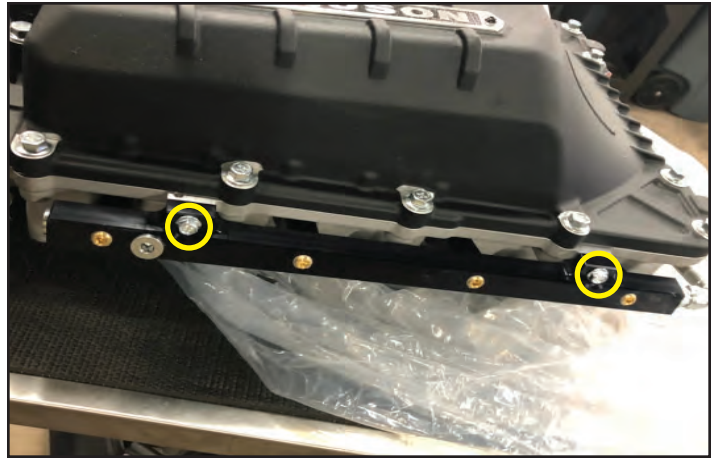

46. Use Lubriplate grease on the O-rings of the injectors. Install the injectors into the fuel rail as shown.

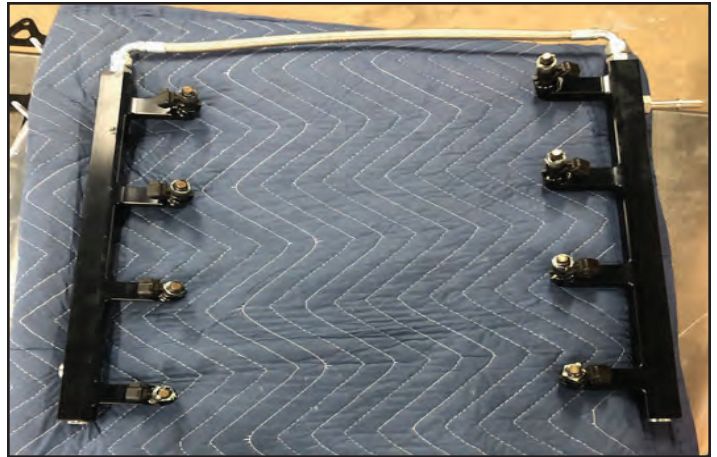

47. Reinstall the fuel rails and torque the fuel rail mounting bolts to 11 ft-lbs.



48. Remove the ambient air pressure sensor (yellow circle) the air intake temperature sensor (blue circle) and the manifold absolute pressure sensor (red circle) from the stock supercharger. (10 mm socket for pressure sensors.)

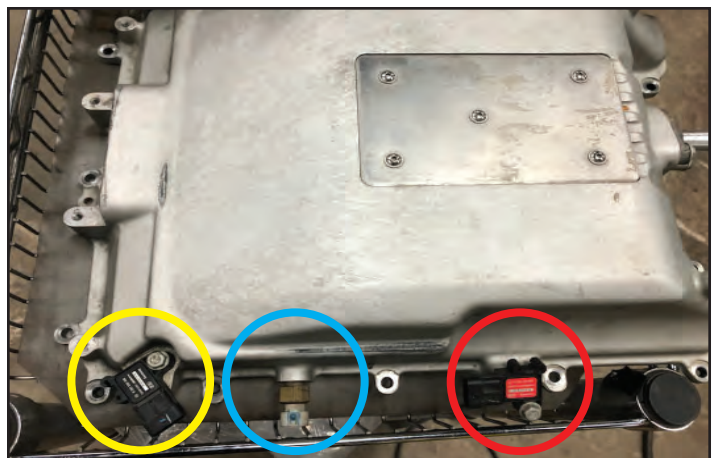

49. Remove the air inlet pressure sensor from the stock supercharger with a 10 mm socket. This will be installed to the provided throttle body adapter.



50. Remove the factory steam vent pipes from the engine. Keep the bolts as they will be reused in the next step.

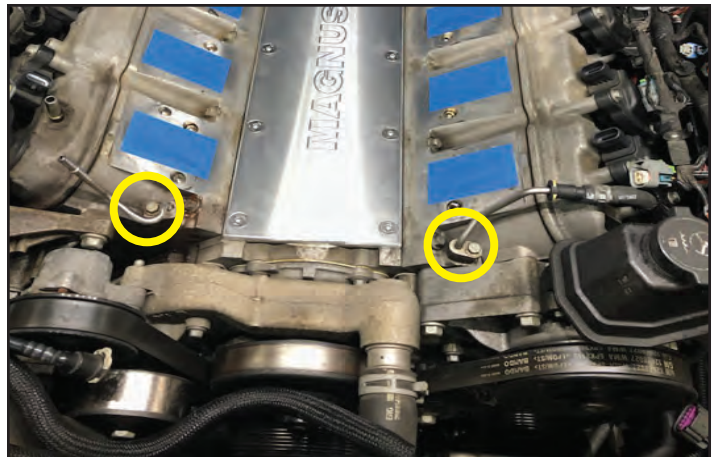

51. Clean the mounting surface for the steam crossover pipe and remove the old O-rings if they are present. Ensure that the new provided crossover has O-rings installed and install it as shown. Reuse the stock bolts and torque to 11 ft-lbs.

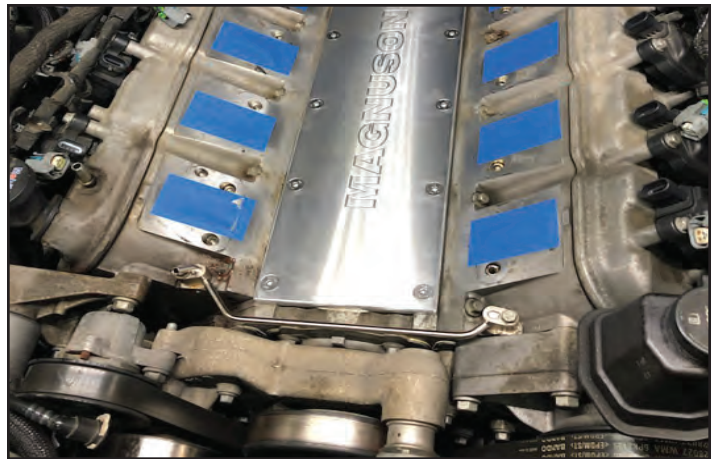

52. Install the manifold air temperature sensor that was removed from the stock supercharger in the location shown with the circle.



53. Install the manifold absolute pressure sensor removed from the stock supercharger. Install in the circled location shown using a M6x20mm bolt.



54. Gather the supplied throttle body adapter and 4 M6 x 25mm bolts. Install the OEM air inlet pressure sensor at the location shown with the circle.

NOTE: Port locations may be slightly different from the image.



55. Make sure the gasket is in place before installing the throttle body adapter to the supercharger housing. **Torque bolts to 108 in-lbs.**

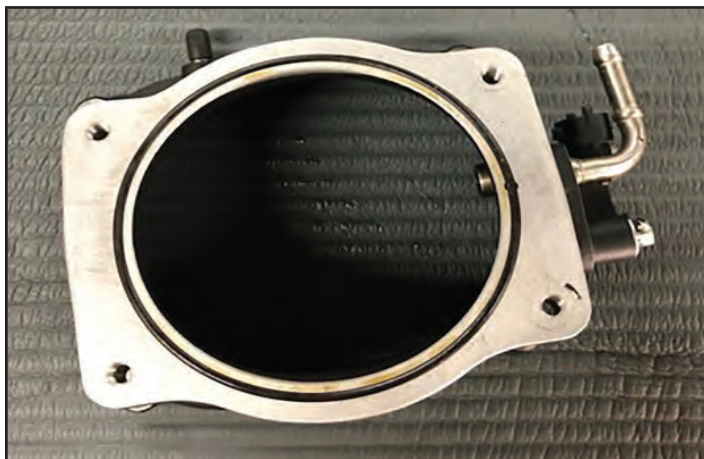

56. Mount the inlet pressure sensor on the inlet of the supercharger using the provided M6x20mm bolt.



57. Remove the supercharger lid bolts using a 13 mm socket. The 4 rear bolts only need to be loosened. (15 bolts total)

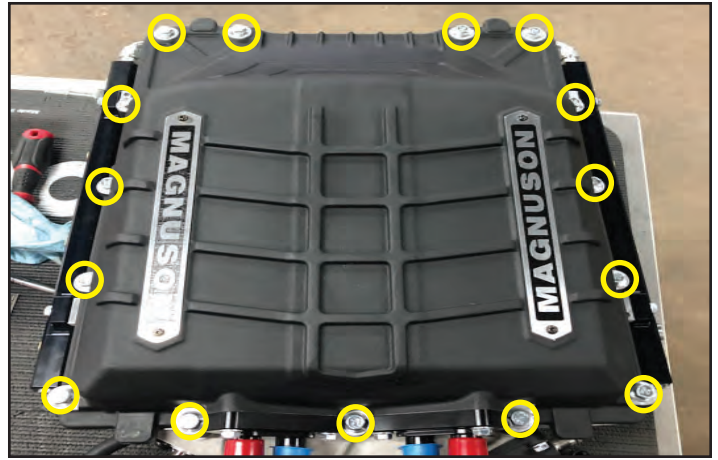

58. Use a tubing cutter and remove 7-9mm from the PCV tube on both passenger and drivers side valve covers.



59. Install the PCV 90 degree elbows with hose menders onto both PCV ports on the valve covers.



60. Remove the tape from the intake ports.
Make sure no debris falls into the ports.



Section 4: Supercharger Installation, Hoses and Electronics

61. Use a piece of wood or something solid to place under the supercharger to keep it elevated off of the cylinder heads. Connect the 8 electrical connectors to the coils and the 8 electrical connectors to the fuel injectors.



62. Remove the wood and set the supercharger down on the intake ports. Use blue Loctite on the M6x40mm bolts. **Torque the bolts to 108 in-lbs following the sequence in the back of the manual.**



63. Install the supercharger lid. Use caution making sure not to roll the O-ring. **Torque the bolts to 18 ft-lbs following the sequence in the back of the manual.**



64. Connect the fuel line to the fuel rail. Push/pull on the connector to make sure it is engaged.



65. Connect the inlet pressure sensor electrical connector.

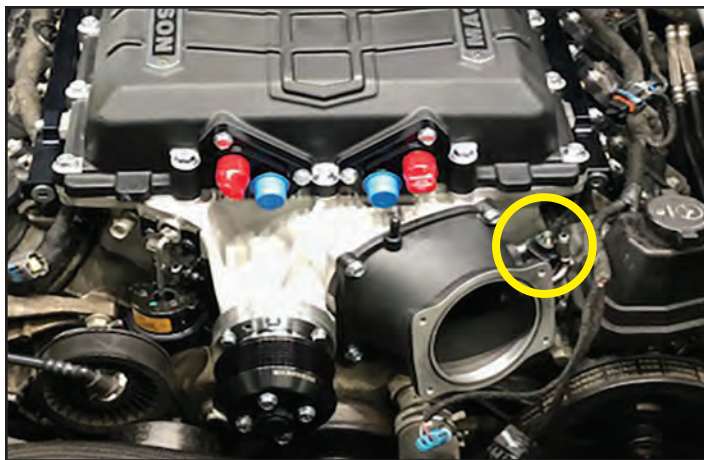

66. Remove the throttle body from the stock supercharger. (4xM6 bolts with 10 mm socket)



67. Using the takeoff hardware from the previous step, installed the supercharger on the new supercharger. Note: On CTS-V with power steering you may need to sand some of the lip off of the reservoir at yellow circle area below.

Torque to 108 in-lbs and connect the electrical connector.



68. Mark the brake aspirator hose 5 inches from the 90 degree bend.



69. Cut the hose at the mark from the last step and install it as shown. You may need to remove the map sensor connectors to get the hose installed. Be sure to reconnect the sensor when you done.



70. Remove the bypass solenoid valve from the stock supercharger shown below. Mount the solenoid using a zip tie to the harness near the electrical connector. Connect the electrical connector to the solenoid.



71. Re-install the supercharger drive belt using the routing shown at the back of this manual.



72. Cut 23 inches from the bulk 3/8 PCV hose.



73. Install the hose from the last step (highlighted in green) onto the mender that was installed on the passenger valve cover in a previous step. The other end connects to the clean air tube.

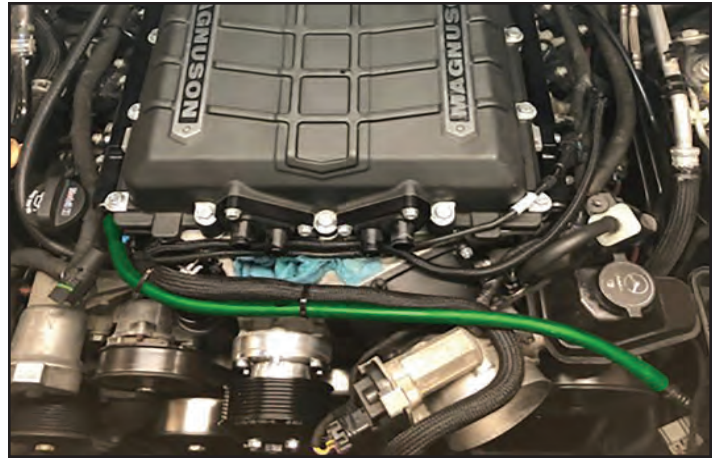

74. Gather the OEM Barometric pressure sensor, locate the harness shown and connect electrical connector.

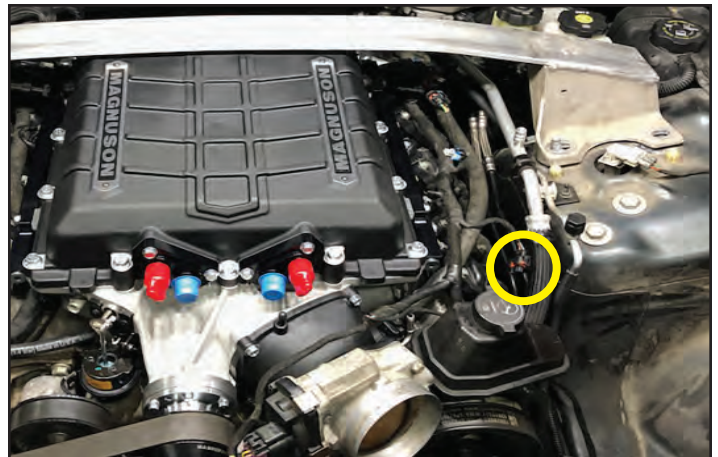

75. Remove the coil bolt from the number 3 cylinder. Gather the provided M6x35mm bolt and mount the ambient air pressure sensor that was removed from the stock supercharger and coil together.



76. Gather the provided IAT sensor jumper harness (highlighted in green). Connect the jumper to the oem harness on the driver's side valve cover. Route the harness over the supercharger and connect the other end to the IAT sensor at the circle location.



77. Gather the provided MAP sensor jumper harness (highlighted in green). Connect the jumper to the oem harness on the driver's side valve cover. Route the harness over the supercharger and connect the other end to the MAP sensor which is located next to the IAT sensor from the last step.



78. Remove the EVAP solenoid from the stock supercharger inlet.



79. Route the stock EVAP line around the back of the supercharger as shown.



80. Connect the EVAP line from the last step to the EVAP solenoid at the red arrow. Connect the EVAP solenoid to the harness at the yellow arrow.



81. Use 5.5 inch of the provided 5/16 EVAP hose. Connect the hose (highlighted in green) to the EVAP solenoid and the supercharger inlet.



82. Locate the drivers side steam vent hose. Cut the hose on each side of the "T" fitting at the yellow lines shown here. Install the provided hose mender between the cut hoses and secure them using 2 Oetiker clamps.

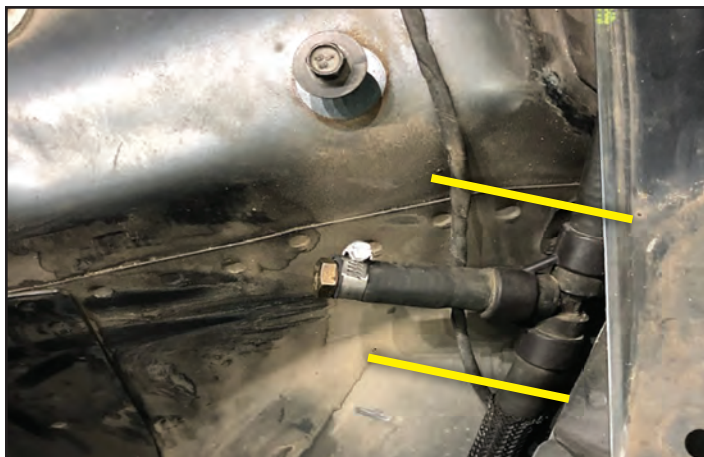

83. Route the passenger side steam vent hose as shown. Use the provided clamp on the steam port below the bypass valve.



84. Reinstall the factory airbox. Install the MAF sensor connector at yellow circle.



85. Install the factory clean air tube. Tighten clamps using an 8 mm socket.



86. Cut 47" of bulk PCV hose. Install the provided restrictor into the hose and secure it using an Oetiker clamp. Install the hose into the fitting on the rear valve cover and route it over to the open port on the passenger's side of the supercharger. Failure to install the restrictor into the PCV hose will cause excessive oil consumption.



87. Reinstall the factory strut tower brace.



88. Re install the front closeout panel along with the side closeout panels.



89. Gather the four 4"x36"x3/4" ID 90-degree coolant hoses and cut them to 2-3/8" on the short side and 36" on the long side measured from the outside edge as shown here. Cover the hoses with the provided sleeving and shrink tube.

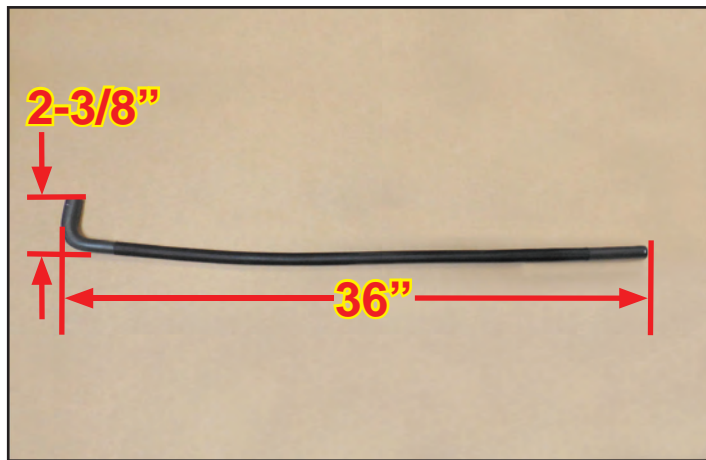

90. Route the four hoses from the last step as shown.

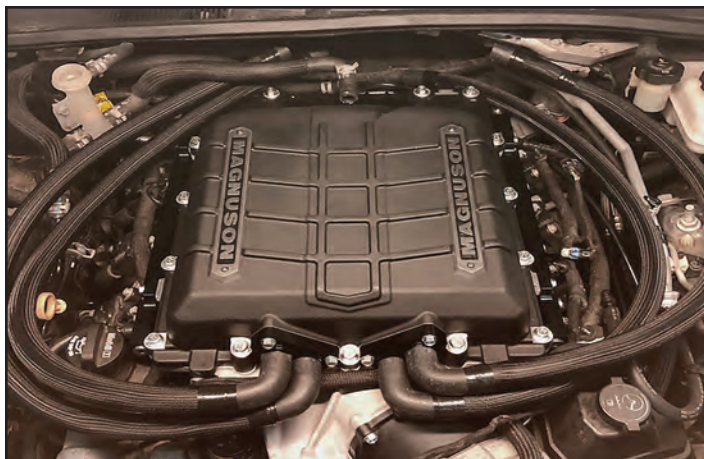

91. Install the 4 constant tension clamps on the front of the supercharger intercooler hoses.

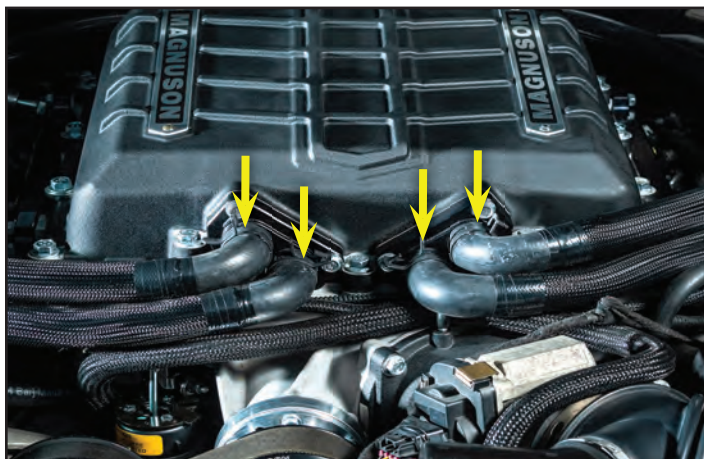

92. Using 2 power grip clamps, secure the lower charge air cooler hoses to the provided coolant "T". Use the original constant tension clamp on the oem hose as shown.



93. Install the upper hoses into the other “T” using 2 power grip clamps. Connect the OEM upper hose that returns to the degas bottle for the intercooler to the “T” at the arrow location.



Section 5: Coolant Fill and Final Testing

94. We highly recommend using a vacuum fill tool to check for leaks and to fill the system.



95. Reconnect the battery negative terminal in the trunk and replace the associated covers reversing the removal steps.



Make sure that you have followed step #1 in this manual to load the proper supercharger calibration to your vehicle's ECM.



96. Start your engine checking for leaks and listening for any unusual sounds or vibrations. There will be a slight whining as the rotors spin. This is a normal sound. Listen for any knocking or pinging (detonation). This vehicle requires 91 octane gasoline fuel and any residual lower octane fuel can create detonation. Run your engine for 5 minutes and shut down.



97. Let the engine cool down and check your intercooler and top off as necessary.



98. Affix the octane requirement fuel sticker to the inside of the fuel door as reference.

*** Use only premium gasoline fuel, 91 octane or better. ***



99. Test drive vehicle for the first few miles under normal driving conditions. **Do not perform any wide open throttle runs.** Listen for any noises, vibrations, engine misfire or anything that does not seem normal. The supercharger does have a slight whining noise under boost conditions, which is normal.



100. Check & bleed the charge air cooler reservoir as needed. After the initial test drive gradually work the vehicle to wide open throttle runs, listen for any engine detonation (pinging). If engine detonation is present let up on the throttle immediately. Most detonation causes are low octane gasoline still in the tank.

After you finish your installation and road test your vehicle, please fill out the warranty registration. This can be found on our website.

If you have questions about your vehicles performance, please check with your installation facility.



Appendix

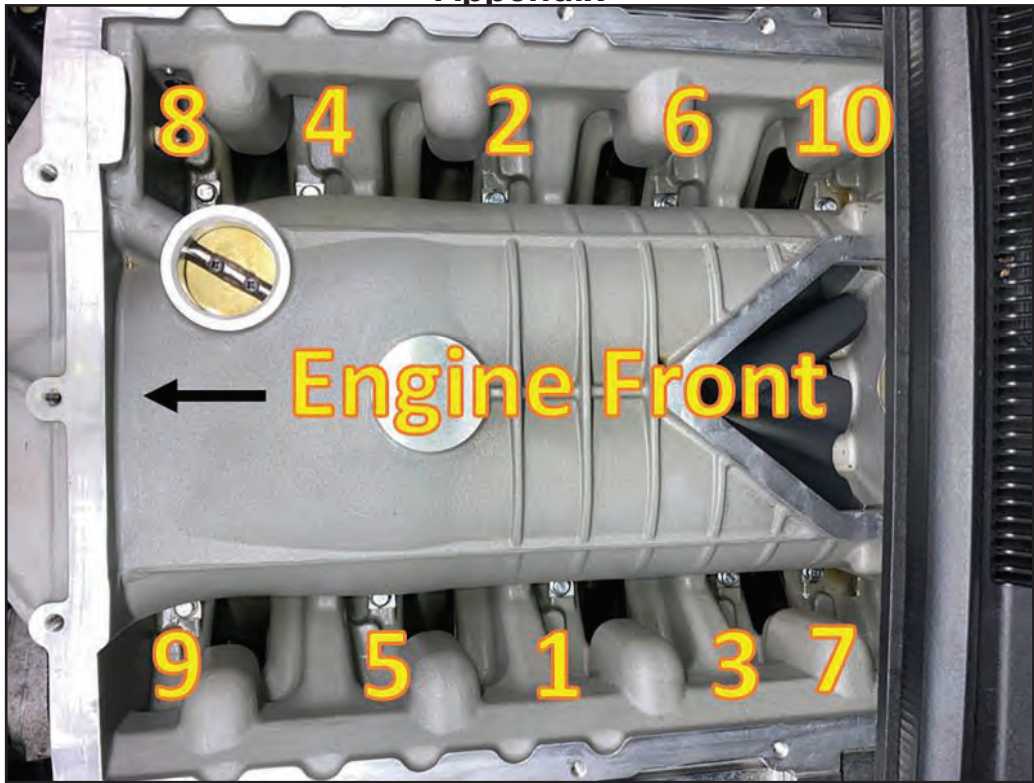

**Supercharger Torque Sequence
(108 in-lbs Final Torque)**

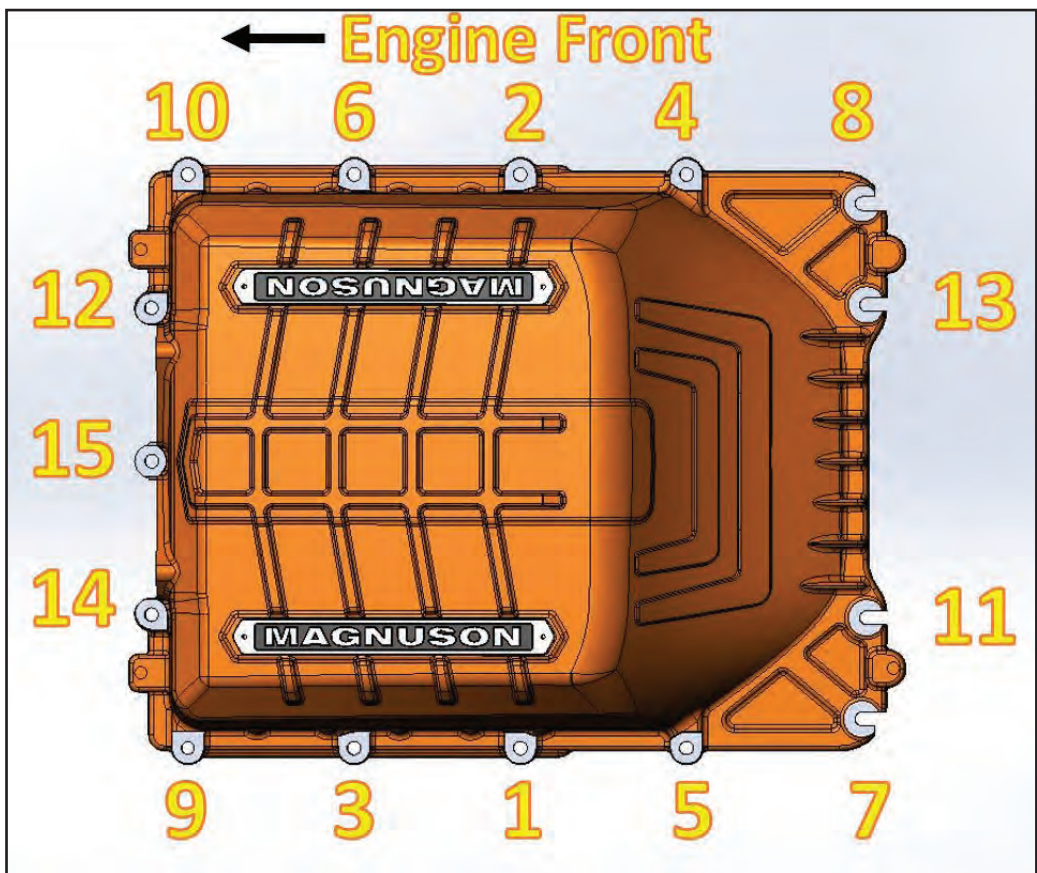

**Lid Torque Sequence
(18 ft-lbs Final Torque)**

Appendix

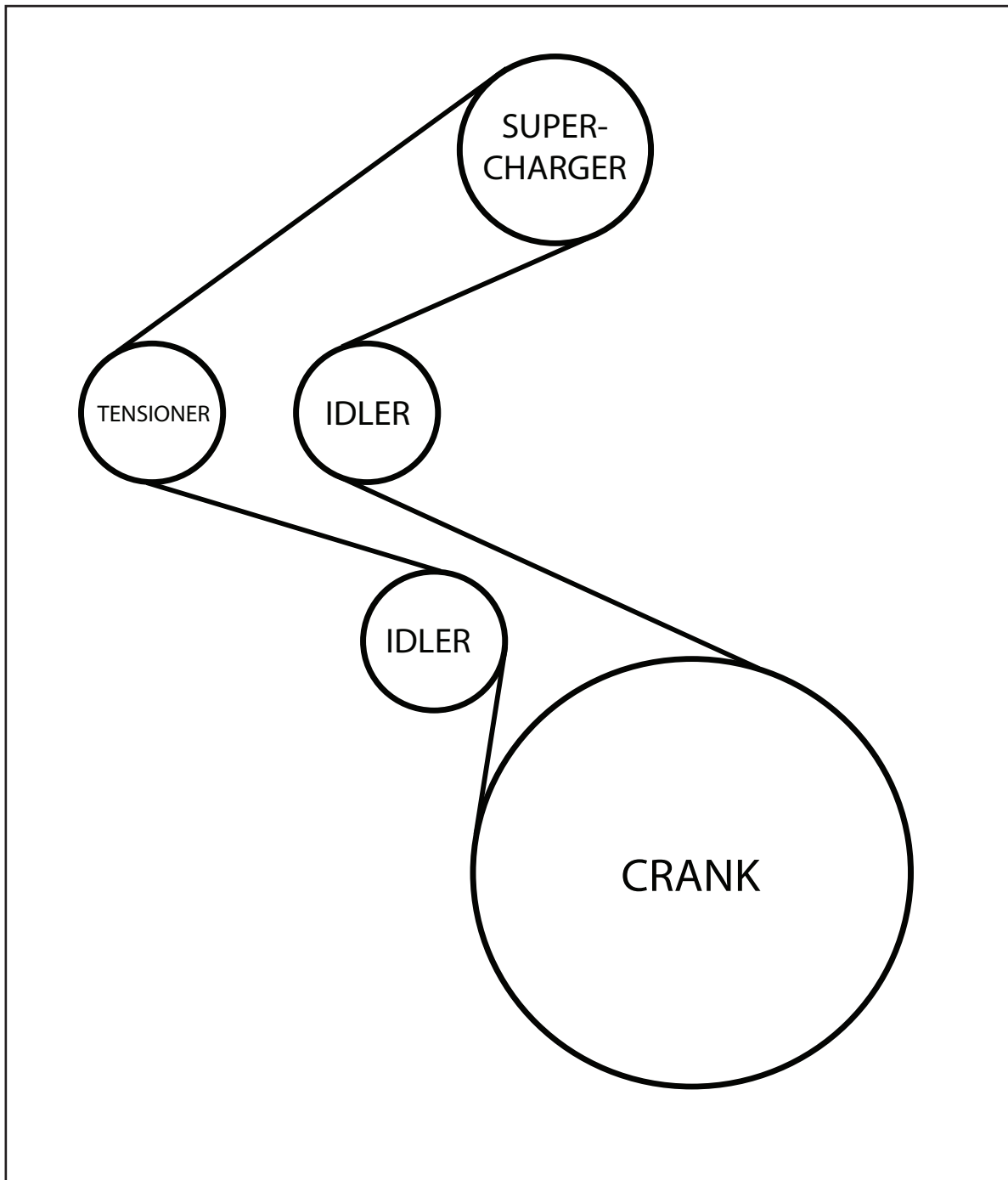

LSA Supercharger Belt Routing Diagram

Notes

Notes

Notes



Please enjoy your Magnuson Supercharged performance responsibly.

This supercharger system requires the use of only premium gasoline fuel, 91 octane or better. The use of non-premium fuel can cause engine failure and will void your warranty. It is NOT compatible with E85, Ethanol, or Flex fuels.

NOTE: Your supercharger system is sensitive to corrosion. You must use the GM specified coolant mixture in the intercooler system as well as your radiator.

MAGNUSON
SUPERCHARGERS