

MAGNUSON

SUPERCHARGERS

Installation Instructions for:
2016+ Toyota Tacoma 3.5L



Step-by-step instructions for installation of
the supercharger system.

*** PREMIUM GASOLINE FUEL REQUIRED ***



ATTENTION!
Your **MAGNUSON SUPERCHARGER** kit
is sensitive to corrosion!
Use **only the vehicle manufacturer**
recommended coolant for your engine in
the intercooler system as well.

Magnuson Superchargers
1990 Knoll Drive, Bldg A, Ventura, CA 93003
(805) 642-8833 phone
magnusonsuperchargers.com

INSTALLATION MANUAL

Magnuson Supercharger Kit: Toyota Tacoma 3.5L

Please take a few moments to review this manual thoroughly before you begin work: Make a quick parts check to be certain your kit is complete (see Bill of Material (BOM) parts list inside the accessory box). If you discover shipping damage or shortage, please call our office immediately. Take a look at exactly what you are going to need in terms of tools, time, and experience. Review our limited warranty with care.

Use only premium gasoline fuel, 91 octane or better.

Magnuson Superchargers recommend that you run a minimum of one (1) tank of premium fuel through your vehicle prior to installation of the system to prevent any possible damage that may occur due to running the supercharged engine on lower octane fuel.

Magnuson Supercharger systems are designed for engines and vehicles in “GOOD” mechanical condition. Magnuson Superchargers recommend that a basic engine system “Health Check” be performed prior to the installation of this supercharger system. Be sure to check for any pending or actual OBDII codes and fix/repair any of the stock systems/components causing these codes. If there are codes prior to the installation they will be there after the installation.

Magnuson Superchargers also recommend the following services to be performed on your vehicle before starting and running the vehicle post supercharger system installation:

- **Unless an engine has less than 5000 miles, it is HIGHLY recommended that new spark plugs are used for this installation. Ensure that the plugs are gapped to Toyota specifications.**
- Fuel Filter change
- Engine oil and filter change using brand name oil (organic or synthetic) and filter

Note: It is VERY IMPORTANT to use the factory specified oil viscosity. The original equipment manufacturer has selected this grade of oil to work with your other engine systems such as hydraulic chain tensioner and variable cam controls. Deviation from this specification may cause these systems to fail or not function properly. Please refer to your owner’s manual for the recommended oil viscosity for your engine and application.

- On newer vehicles not requiring new spark plugs it is important to verify the spark plug air gap.

On older vehicles Magnuson Superchargers recommend these additional services be performed:

- New spark plugs with the air gap set at the factory specifications OR new specifications if required by the installation manual.
- Coolant system pressure test and flush. **NOTE: YOU MUST USE TOYOTA SPECIFIED COOLANT MIXTURE!**

Non “Magnuson Approved” calibrations or “tuning” will Void ALL warranties and CARB certification.

Our supplied calibration is designed for use with the components provided in this kit. Any adjustment to the intake, or exhaust systems or other engine components may adversely affect engine performance and may trigger your check engine light.

Tools Required

Metric wrench set

Metric 3/8" and 1/2" drive metric socket set (standard & deep)

3/8" and 1/2" drive ft-lbs and in-lbs torque wrenches

Metric Allen socket set 3/8 drive

Metric Allen wrenches

Phillips and flat head screwdrivers

Serpentine belt tool

Funnel

Drain pan

Hose cutters

Safety glasses

Nut driver

Compressed air

Air gun

Impact gun and socket set

Heat gun

Torx socket set 3/8 drive

E6 External Torx Tool

E8 External Torx Tool

6.2 Quarts of Oil (Manufacturer's Specification) and Oil Filter

Contact Information:

Magnuson Superchargers

1990 Knoll Drive, Bldg A

Ventura, CA 93003

Sales/Technical Support Line (805) 642-8833

Websites www.magnusonsuperchargers.com

Email sales@magnusonsuperchargers.com

Table of Contents

Section 1: Initial Preparation	5
Section 2: Coolant System Drainage and Grill Removal	6
Section 3: Intake Manifold Removal	11
Section 4: Lower Intake Manifold Preparation and Installation	19
Section 5: Oil Cooler Spacer Installation	24
Section 6: Crank Pulley and Idler Bracket Installation	27
Section 7: Harness and Hose Rerouting	33
Section 8: LTR and Pump Installation	35
Section 9: Pump Electrical Connection	41
Section 10: Coolant Hose Routing	49
Section 11: Supercharger Preparation and Installation	52
Section 12: EVAP Routing	61
Section 13: Coolant Reservoir and Belt Installation	64
Section 14: Radiator Hose and Inlet Installation	67
Section 15: Oil and Coolant Fill and Final Testing	72

NOTE TO CUSTOMERS WITH MODIFIED VEHICLES:

The Magnuson calibration included with this kit is intended to work on stock vehicle configurations, including stock trim levels and stock OEM vehicle options. Modifications to your stock vehicle including, but not limited to, engine, flywheel, clutch, torque converter, transmission, wheels, tires, axles, gears, driveshafts, induction system, exhaust system and additional weight (ie. bumpers, racks, etc.) can have a significant impact on your vehicle's calibration and may require modifications to our calibration as supplied.

While we attempt to minimize the need for modifications during our development process, it is impossible for our team to account for all possible build variations/combinations, and in some cases it may be necessary for you to supply an additional element of customization for your vehicle—custom calibration—and to work, at your own direction and expense, with a local service facility to address your unique combination of hardware and make calibration adjustments as necessary.

Please be aware that standard product warranties and governmental emissions certifications are predicated on stock vehicle configurations, and vehicle modifications and calibration changes may affect or even void powertrain warranty and emissions certification status (such as CARB emissions certification). It is the sole responsibility of the customer making a warranty claim to prove that any vehicle modifications and calibration changes were within warranty. It also is the sole responsibility of the customer to determine if the modifications and changes comply with all local, state and federal emissions standards.

Any reference to left or right side of vehicle is given from driver's seat perspective.

Section 1: Initial Preparation

1. **If your kit has a provided handheld tuner follow the instructions in the provided pamphlet to install your tune. Your handheld tuner may not match the one shown.**



2. Your Intercooler system is sensitive to corrosion. It's very important to use the OEM recommended coolant mixture in your supercharger system as well.



3. Your system requires the use of a minimum 91 Octane gasoline fuel. This system is **not** compatible with E85 fuel.



4. Remove the fuel cap to depressurize the fuel system.



5. Remove the fuel pump 15 Amp NO.4 Fuse from the hood fuse panel shown here with the yellow arrow. Start the vehicle to release pressure from the fuel rail/line prior to disassembly. Once you have purged the fuel pressure you can replace the fuse.

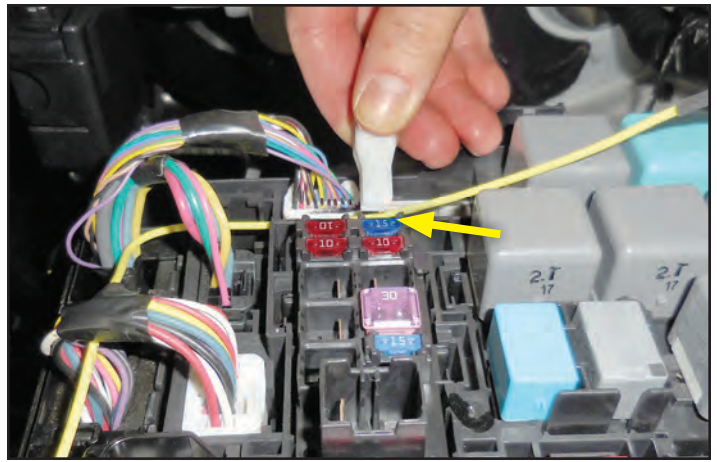

6. Remove the negative battery cable with a 10mm wrench. The battery is located in the left front area of the engine compartment. Insulate the wire removed in the last step with a towel or tape and tuck it behind the battery to prevent it from making a connection. Also cover the negative terminal with an appropriate cap.



Section 2: Coolant System Drainage and Grill Removal

Allow the engine to cool down before draining any fluids.

7. **Not on all vehicles have this accessory.** The upper black plate is light weight steel and has 4 bolts retaining it. The lower TRD skid plate is very heavy so you will need some help with its removal. **Have someone hold the TRD skid plate** while you remove the 6 bolts holding it in place (4 shown with arrows).



8. Drain the engine oil, and replace the oil filter at this time. **Do not fill the engine oil until after the oil cooler spacer has been installed in a later step. There is a reminder in Section 15 about the oil fill.**



9. Place a hose from the spigot of the radiator petcock to a clean drain pan to allow reuse. Open the petcock valve shown with the yellow arrow here. Remove the radiator cap to allow the coolant system to drain faster. If the coolant is clean enough you will be able to reuse it. **Ensure that you close the petcock after all the fluid has been drained.**



10. Unplug the electrical connection shown with an arrow.



11. Use a pick to push in on the tabs that hold the fastener shown with the arrow in order to release it.



12. Use a 10mm nut driver to remove the bolts shown at the arrow locations for the grill support.



13. Remove the plastic rivet, highlighted in green and shown with an arrow, holding the grill near the drivers side headlight with a small screwdriver. Repeat the process from the last step on the plastic rivet located by the other headlight.

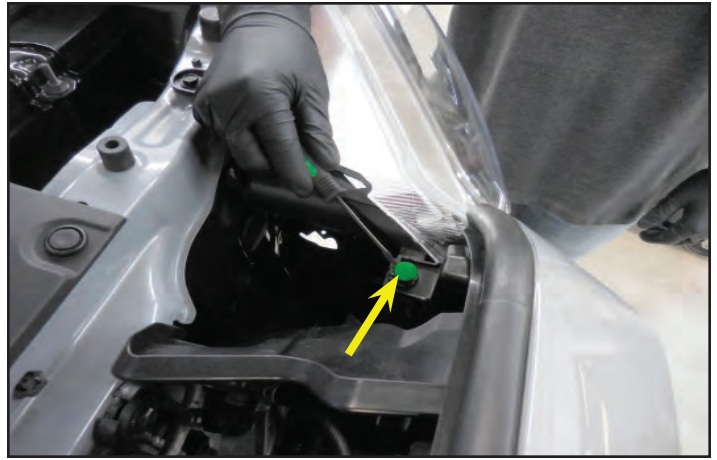

14. Once the upper fasteners have been removed grab the grill at the lower location shown with the arrow and pull outwards. This process should release the retainers on the bottom of this side of the grill. Repeat the process from the last step on the other side of the grill. Remove the grill and place it in a safe area.



15. Remove the two horns at the arrow locations using a 12 mm socket wrench. Unplug the electrical connections for the horns and set them aside.

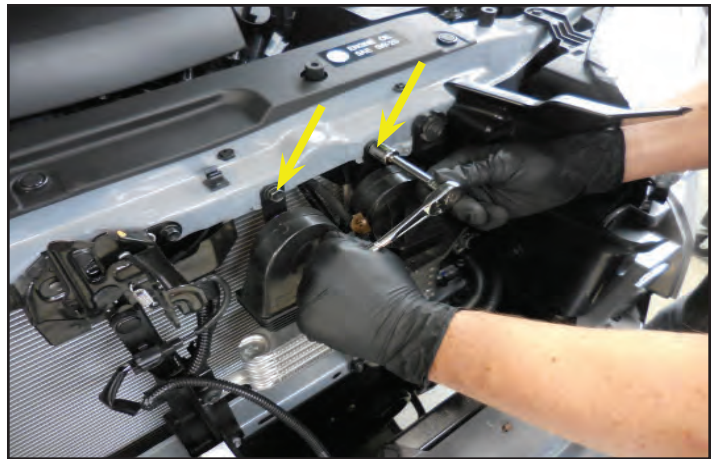

16. Remove the cover for the bolt shown with the arrow.

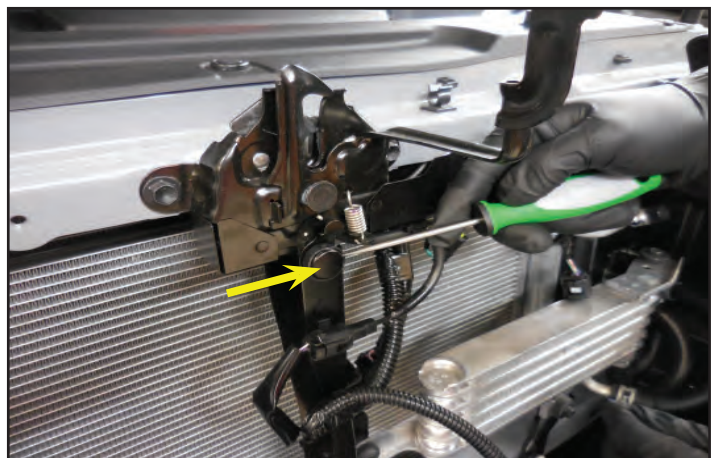

17. **This is only on the 2018+ Tacoma.** Unplug the electrical connection at the arrow location.

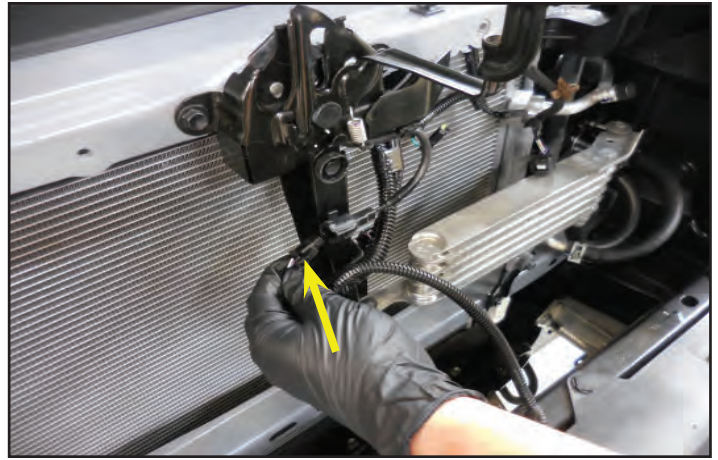

18. For 2018+ Tacoma remove the female plug side of the electrical connection, shown with an arrow, from the bracket. For 2016/17 unhook the harness mount.

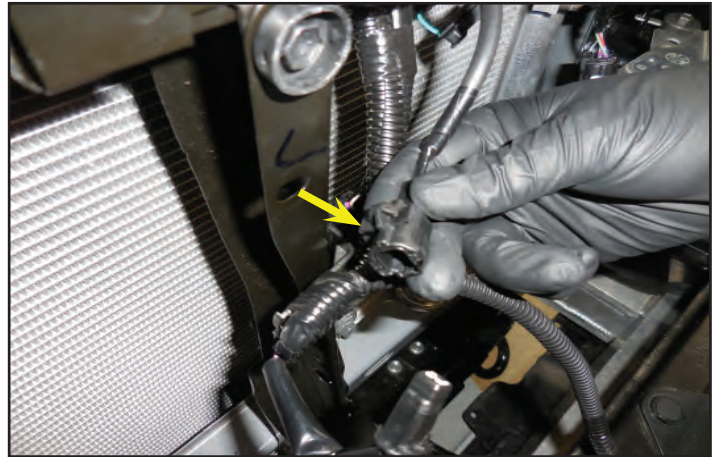

19. Remove the bolt that is under the cover shown here with an arrow using a 10 mm socket wrench.

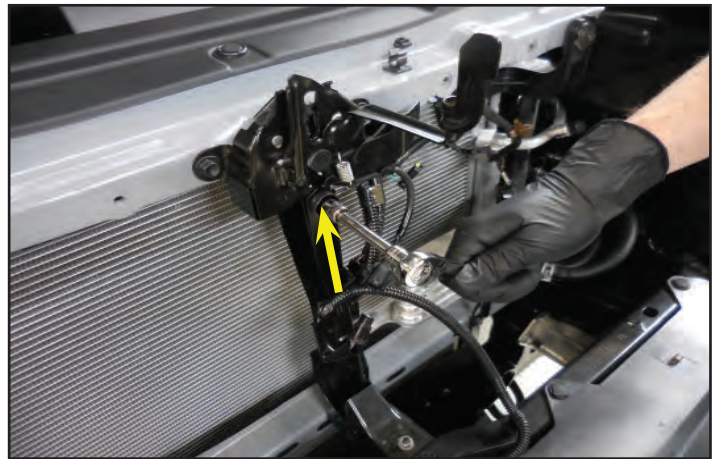

20. Remove the two bolts holding the hood latch assembly using a 10 mm socket wrench.

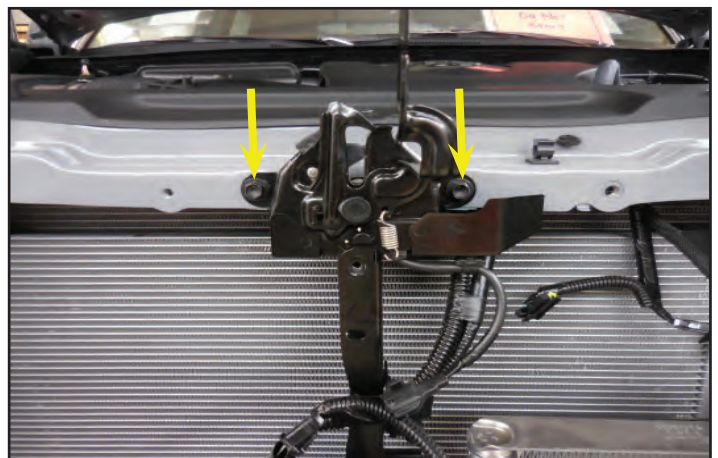

21. Remove the cable housing from the hood latch assembly. Disconnect the ball end of the release cable from the hood latch assembly by pulling up. Set the hood latch assembly aside for now.

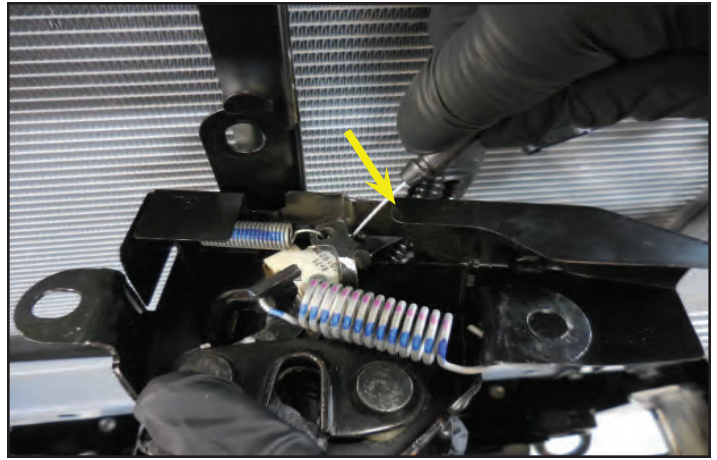

22. Remove the rivet/push pin shown with an arrow at the plastic side closeout. Passenger side shown.



23. Pry loose the clip shown at the arrow location. Passenger side shown.



24. Release tab at arrow location and push through.



25. Release tab on opposite side at arrow location and push through.



26. Pull clip out and repeat on other side.



27. Remove the plastic side closeout. Tip inward for removal.



Section 3: Intake Manifold Removal

28. Pull up at the front of the engine cover to release it and remove it from the truck.



29. Unplug the MAF electrical connection.



30. Pry the retainer open to remove the electrical cable for the MAF sensor.



31. Remove the connector holding the MAF sensor wire from the back of the air box resonator at the arrow location.



32. Loosen the hose clamp at the throttle body (yellow arrow) using a 10mm socket. Release the hose clamp from the vent hose and pull the hose loose (red arrow).

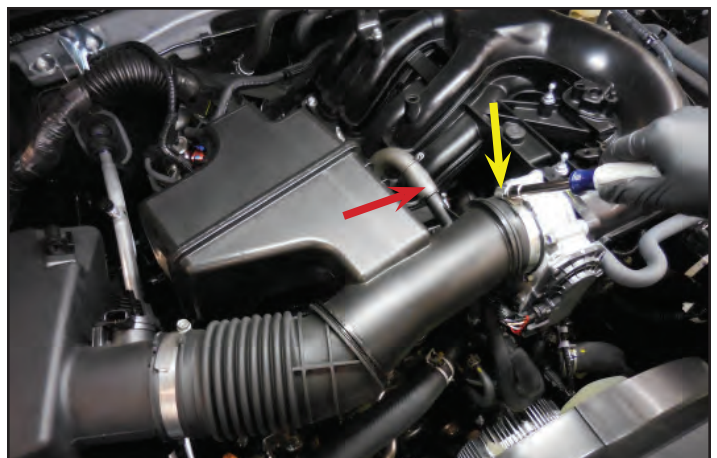

33. Release the two spring clips that hold the airbox lid near the fender. Lift up the airbox lid along with the clean air hose assembly and remove it from the truck. Reuse the lid at a later step. The air duct will be replaced. Remove the air filter and inspect for cleanliness. Replace if necessary. Place the air filter in a bag to keep it clean.



34. Unplug the throttle body electrical connection (red arrow). Remove the 4 throttle body bolts with a 10 mm socket (yellow arrows). These bolts will be reused. Disconnect the hoses and set the throttle body aside in a safe place until reused in later steps.

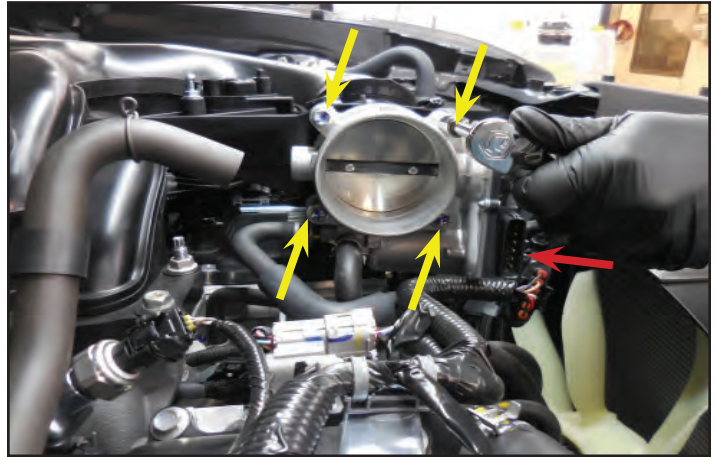

35. Unplug the VSV electrical connection shown at the yellow arrow location and release the hose clamp and pull the hose at the red arrow.

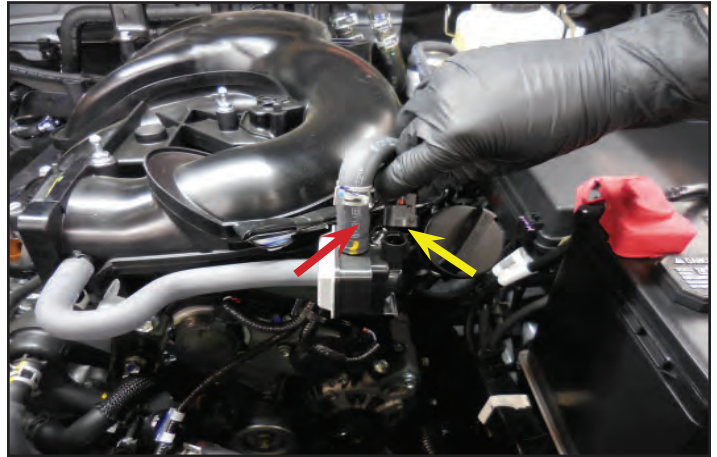

36. Pull the hose shown out of the way.



37. Release tabs on the underside and press the wire retaining fitting out of the location shown with the arrow.

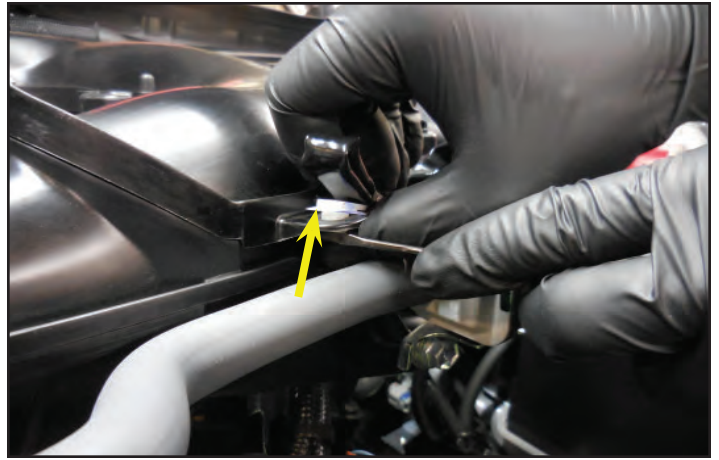

38. Release tabs through middle slots and pry the wire retaining fitting out of the location shown with the arrow.

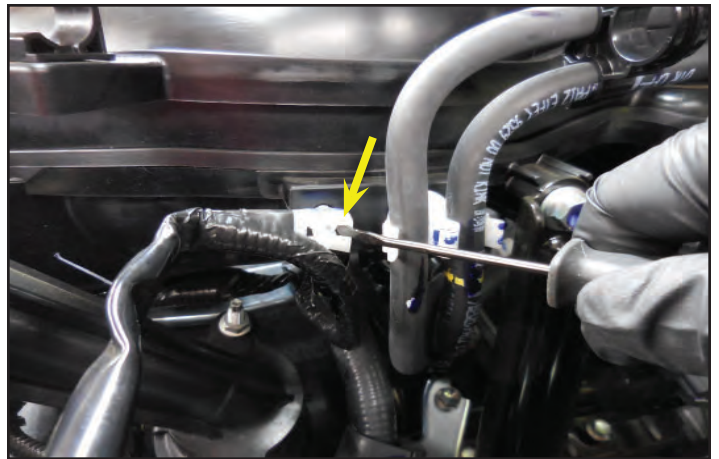

39. Pull the hose shown with the arrow away from its retainer.

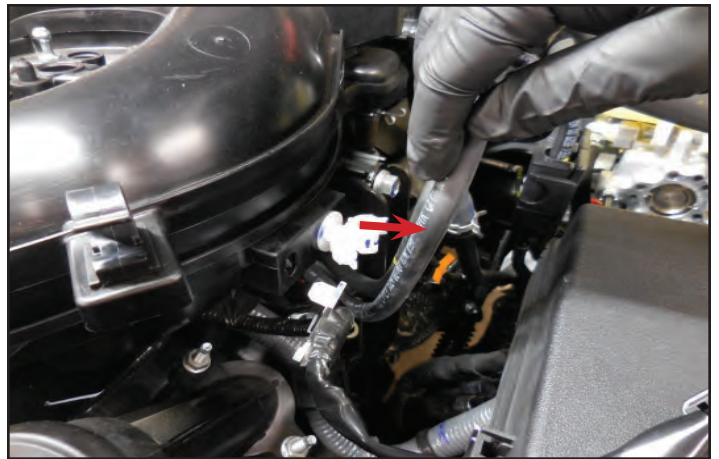

40. Remove the PCV hose line shown from the intake manifold.



41. Remove the bolt holding the heater hose bracket at the rear of the intake manifold using a 10 mm socket wrench. This bracket will not be reused.

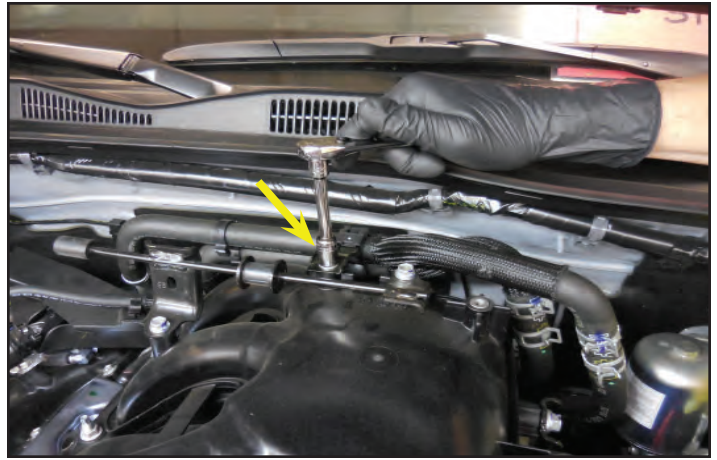

42. Remove the bracket bolt at the rear of the intake manifold using a 12 mm socket wrench. The bracket will be reused, but the bolt will not.



43. Remove the bracket bolt at the middle of the intake manifold using a 12 mm socket wrench. The bracket will be reused, but the bolt will not.



44. Remove the bracket bolt at the front of the intake manifold using a 12 mm socket wrench. Completely remove the bracket at this point by removing the bolt on the timing cover. The bracket and both bolts will not be reused.



45. Remove the 6 bolts and 2 nuts holding the upper intake manifold to the lower intake manifold using a 12 mm deep socket wrench.

It is VERY important to not contaminate your work environment or allow any debris to fall into the exposed ports, or engine damage can occur.



46. Disconnect the vent hose shown. This will be reused later.



47. Unplug the fuel rail pressure sensor.



48. Unplug the electrical connection going to the fuel injector rail.

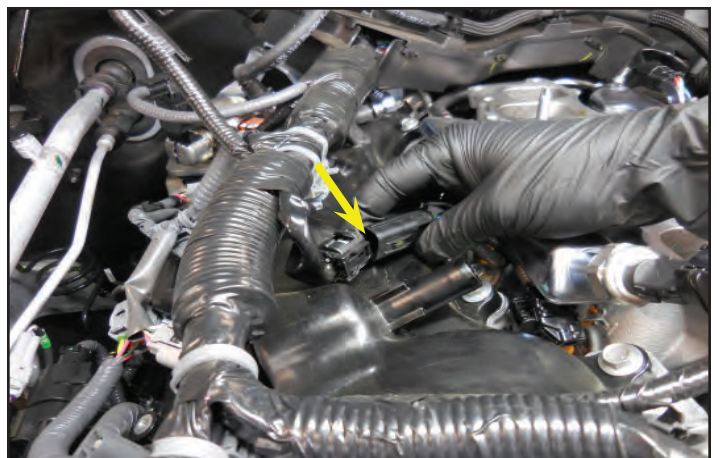

49. Unplug the electrical connection going to the other fuel injector rail.



50. **Have some shop towels ready for fuel spillage. Wear safety glasses while removing the fuel line fittings.** Disconnect fuel inlet to fuel rail. NOTE: Pull up on the blue locking tab and pull to remove. NOTE: Be prepared to wipe any excess fuel from line and rail before proceeding. **Cap and plug the fuel line fittings.**



51. Remove the 10mm nut and stud shown at the arrow that holds the bracket in place. These will be reused later.



52. Un-clip the harness at the arrow location and lift the wire harness up from the back of the engine and secure it out of the way to allow the removal of the lower intake manifold.



53. Remove the nuts and bolts holding the lower intake in place using a 12 mm socket wrench. The nuts are at the corners and the bolts are in the middle. You may need to lift up on the harness and push back to clear the fuel crossover. Pull the lower intake manifold out of the truck.

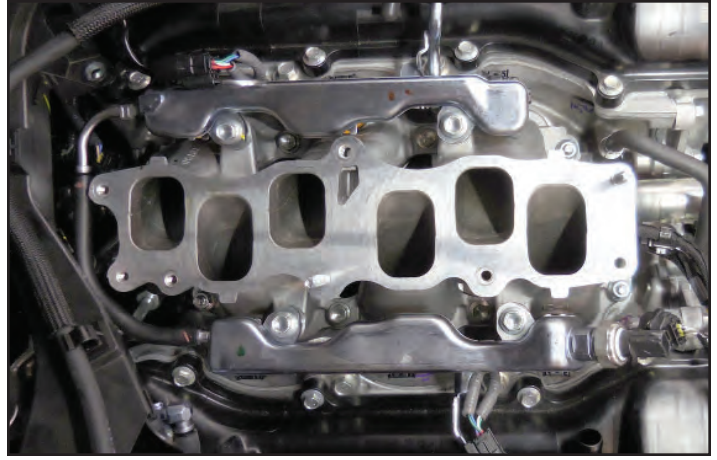

54. **Ensure that you do not damage the fuel injectors as you place the manifold upside down on a clean table.**



55. Carefully remove the intake gaskets. Carefully clean and inspect the OEM gaskets. The black surfaces are rubber so be care not to scratch. Replace if damaged. Toyota P/N: 17177-0P030



56. Carefully clean up the surface around the intake ports. Use isopropyl alcohol to clean the surface around the ports. **Make sure nothing enters the intake ports.** Apply blue tape over the ports to prevent anything from entering the engine.



Section 4: Lower Intake Manifold Preparation and Installation

57. Prepare the lower intake manifold for fuel injector removal. **Once again ensure that you do not damage the injectors as you flip the assembly over. Find a block of plastic or wood that is thicker than the protruding ends of the fuel injectors to rest the manifold on while it is turned over.**



58. Flip the lower intake manifold over on top of the a wood or plastic block. **Ensure that the injectors do not contact any surfaces.**



59. Remove the 4 bolts shown with arrows using a 12mm socket wrench. These bolts will be reused. Remove the fuel rail assembly from the lower intake manifold. Pull up at each injector to avoid spilling fuel.

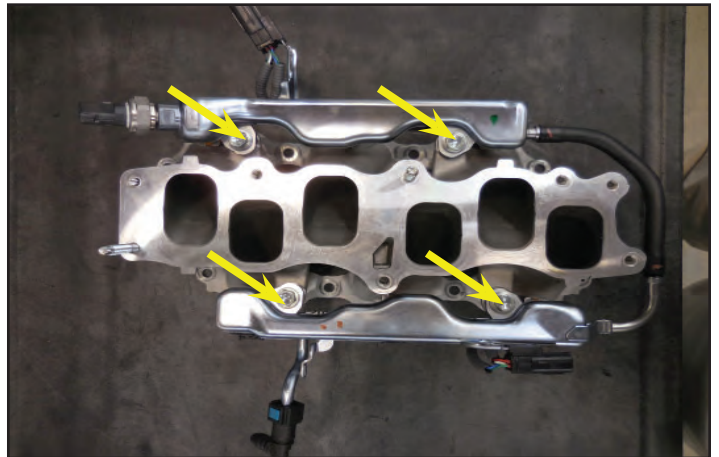

60. Remove the 4 spacers for the fuel rail assembly. These will be reused.



61. Remove the 6 fuel injector O-rings. You may need to use a pick to carefully remove these O-rings. **Do Not damage any of the sealing surfaces.** Clean the O-rings and inspect them for damage. Replace if necessary. Toyota P/N: 23291-0V020 (each).

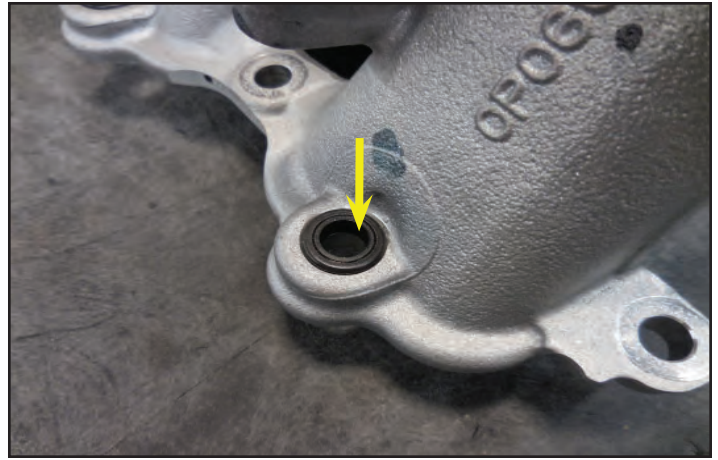

62. Place the clean O-rings into the Magnuson supplied lower intake manifold.

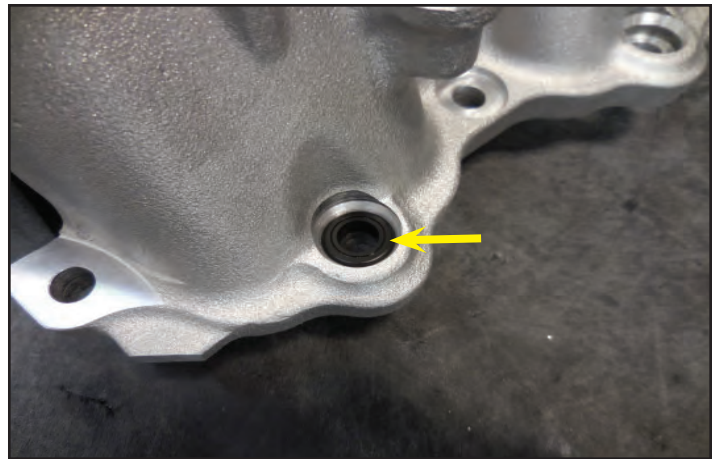

63. Install the 4 spacers from the OEM lower intake manifold into the Magnuson lower intake manifold. Place the manifold onto the block that was used earlier to raise it enough for injector installation.

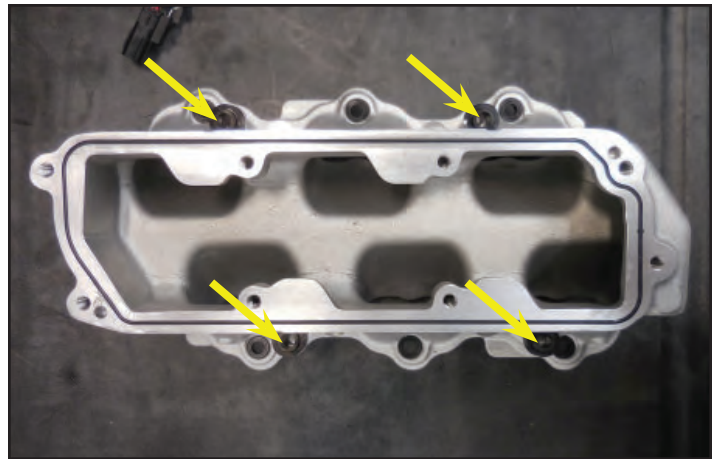

64. Carefully insert the fuel injectors back into the O-rings on the Magnuson lower intake manifold. Ensure that the hose shown is on the side of the manifold with the protrusion shown with an arrow.



65. Install the four OEM bolts to secure the fuel rail assembly. When tightening bolts make sure the spacers stay seated properly and that the fuel rail locates on them. **Torque the four bolts to 18 ft-lbs.**

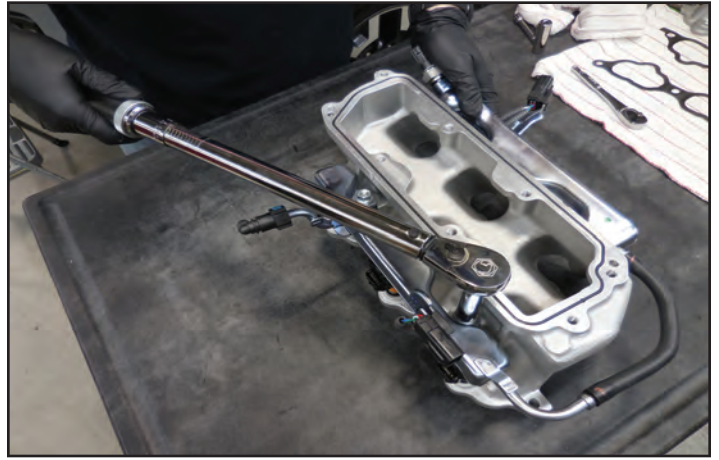

66. Remove the tape from the intake ports. Clean around the ports with isopropyl alcohol.

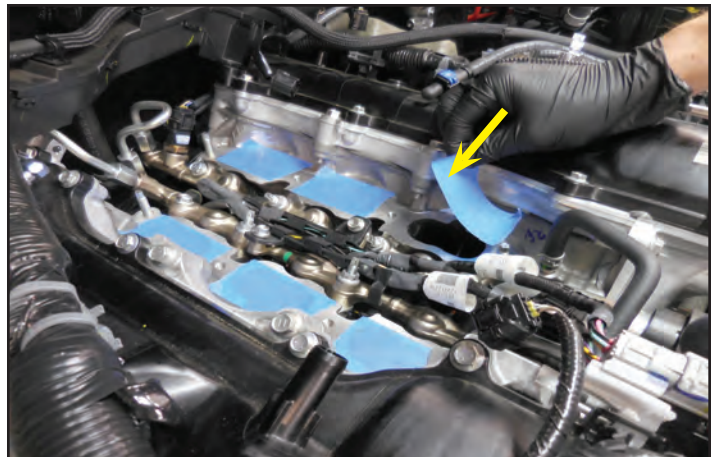

67. Install the OEM gaskets onto the intake ports. Ensure that the tab on the passenger side gasket (red arrow) faces to the rear and the tab on the driver side (yellow arrow) gasket faces to the front as shown.

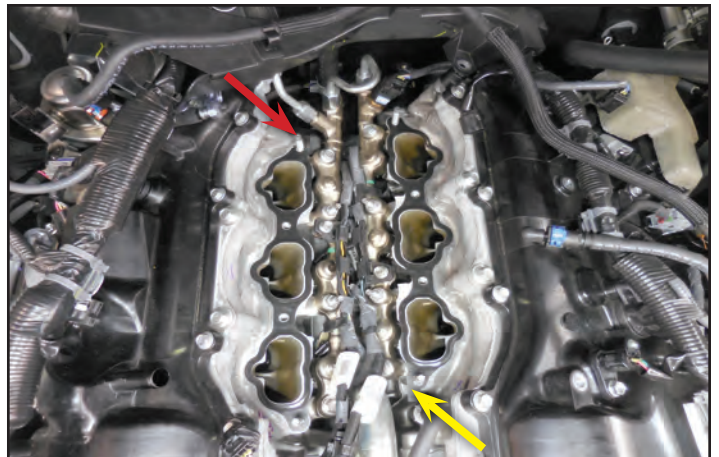

68. Install the Magnuson lower intake manifold that was prepared earlier. You may need to pull up and push back on the rear harness again to gain clearance for the rear fuel cross over. **Ensure that the manifold sits flush with the intake ports. NOTE: Cover the opening of the Magnuson Lower Intake Manifold with tape as shown to prevent debris from going into the intake.**



69. Use a magnet to install the OEM fasteners back in their original locations. Lightly tighten the fasteners with a smaller 12 mm wrench to ensure that everything lines up right. **Torque the lower intake manifold bolts to 18 ft-lbs following the torque sequence shown at the back of this manual.**

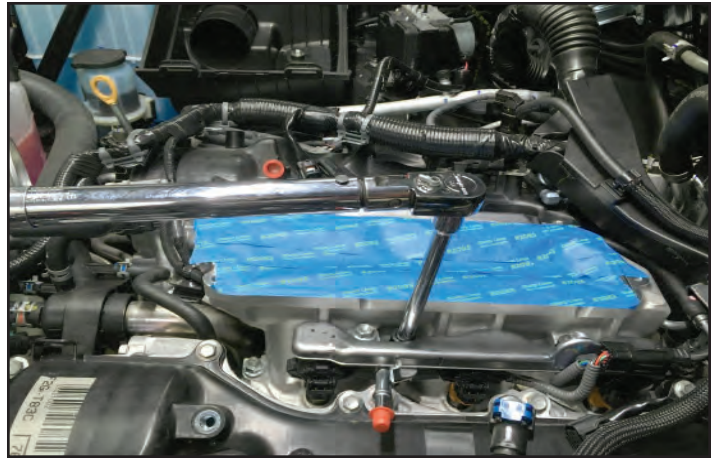

70. Plug in the two electrical connections for the fuel rails.



71. Install the fuel line at the inlet tube and ensure that the security lock is fastened.

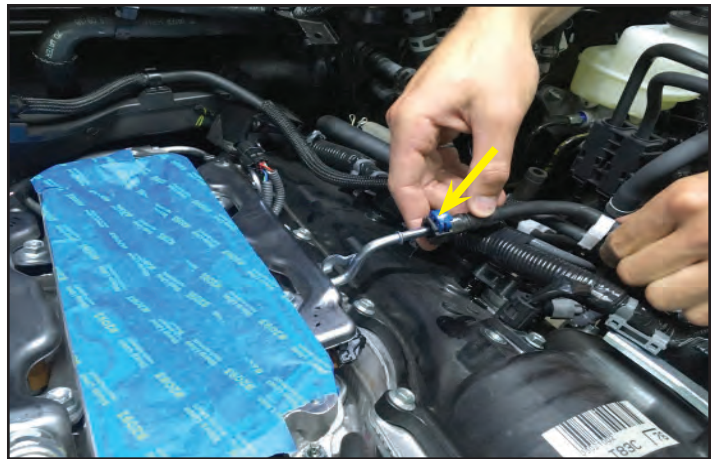

72. Remove the plastic clips at the arrow locations holding the top radiator closeout panel. Lift up on the center of the rivet followed by the outside piece as shown below.

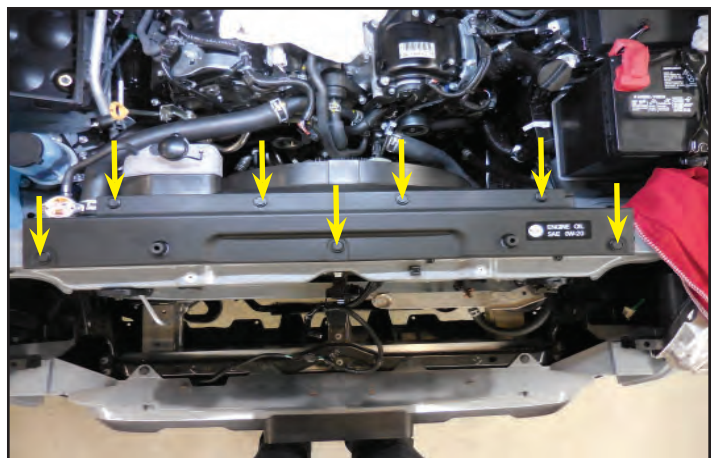

73. Un-clip the cable latch on the driver's side at the arrow location that is holding the hoses shown.

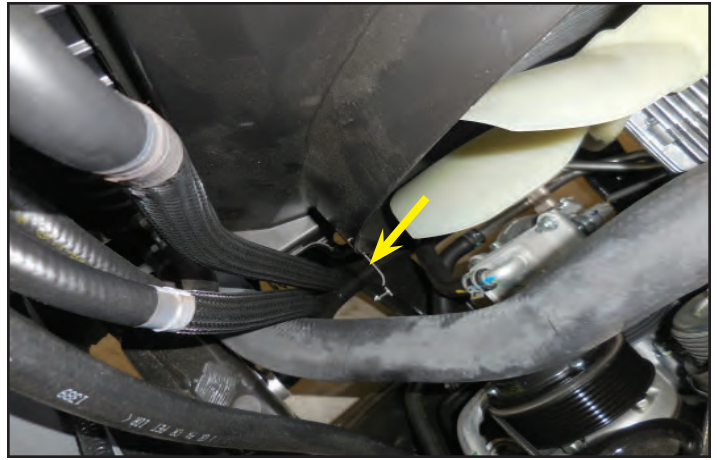

74. Remove the hose going to the radiator overflow tank. You may need to plug or cap the hose to prevent coolant from leaking out.

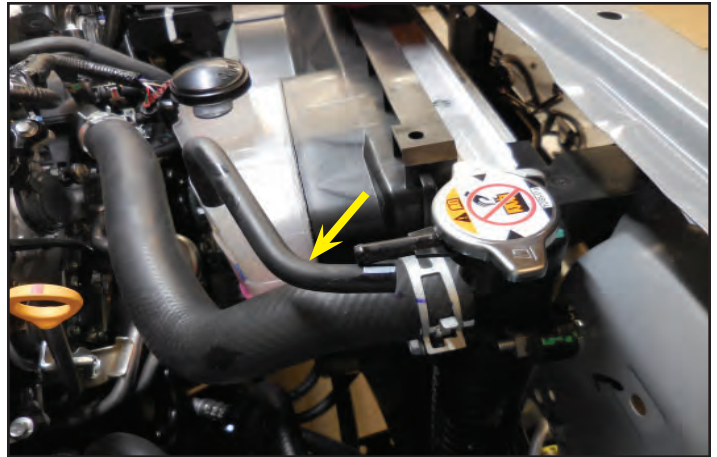

75. Use a 12mm wrench to loosen the 4 nuts holding the radiator fan blade to the pulley shown. Do not remove at this time. The belt tension should be enough to hold the pulley in place. If not use a strap wrench as well.

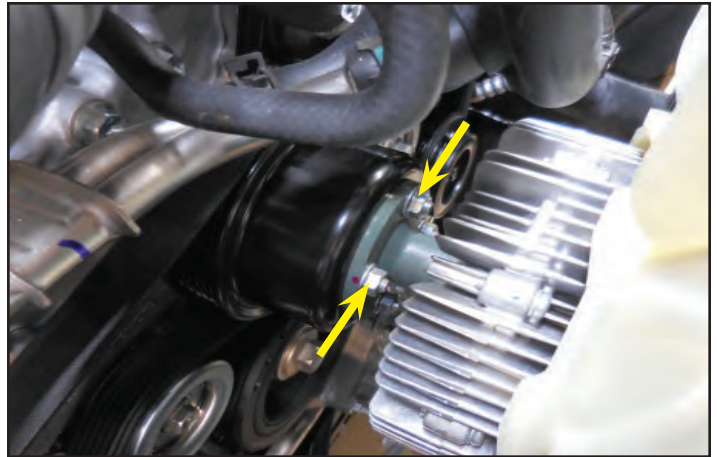

76. Remove the bolt holding the radiator shroud in place on the left side of the truck with a 10 mm socket wrench. Repeat the process on the right side of the radiator. These bolts will get reused.



77. This step is easier with two people. Completely remove the 4 nuts holding the radiator fan in place and take the radiator shroud and fan out of the vehicle together as shown.



78. Once you have removed the fan reinstall one of the nuts to secure the pulley in place.

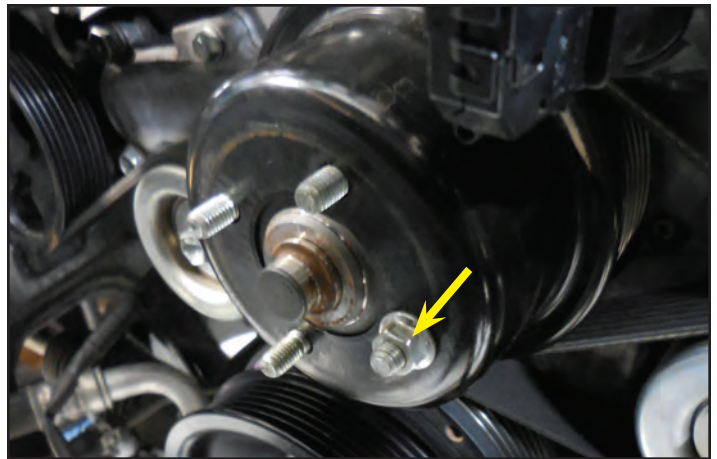

79. Prepare to catch the remaining coolant before performing this step. Loosen the clamp and remove the lower hose connection at driver's side of the radiator near the petcock. The hose has been highlighted here in green. Loosen the clamp and remove the engine side of this hose as well. The clamps will be reused and the hose can be discarded.

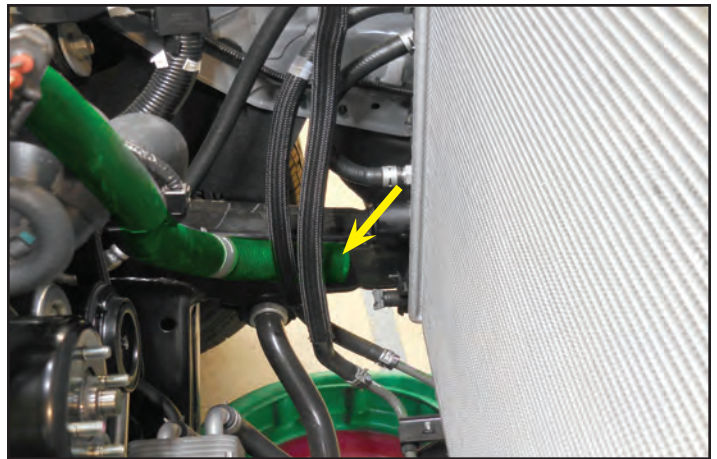

Section 5: Oil Cooler Spacer Installation

80. If you have an oil cooler you will need to add the provided spacer to it. Locate the OEM Oil Cooler near the crank damper on the front of the engine. Unplug the electrical connector (green arrow). Remove bolt (red arrow) with a 10mm socket. Also remove the 2 nuts and 1 bolt shown with yellow arrows with a 12mm socket that mount the Oil Cooler to the engine. Keep this hardware as it will be re-used in the following steps.

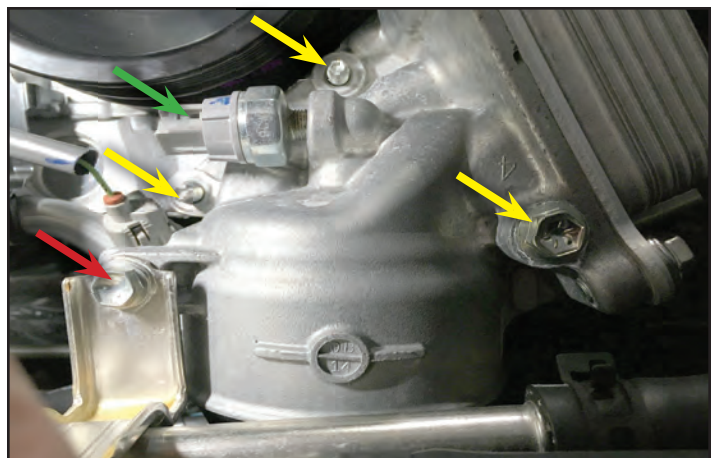

81. With mounting fasteners removed pull out on the Oil Cooler to remove it from the engine. Leave the hoses attached and let the Oil Cooler rest out of the way as shown.



82. Remove the 2 studs used to mount the Oil cooler using an E8 bit or stack the two nuts on the stud to remove. Keep this hardware as it will be re-used.

NOTE: Oil Cooler is shown in place for clarity.

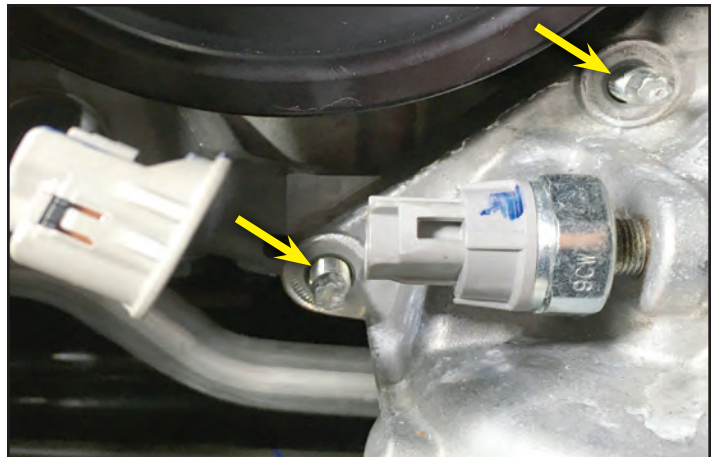

83. Gather the supplied Oil Cooler Spacer Plate along with one of the supplied new gaskets and 3 socket head M8 bolts. Assemble as shown and apply blue Loctite 242 to the three bolts as shown.

Do Not get Loctite on the gasket!



84. Install spacer plate onto the engine where the OEM Oil cooler Mounts. **Torque bolts to 18 ft/lbs.**



85. Apply blue Loctite 242 to the studs and install them into the two locations shown with yellow arrows.



86. Install the second supplied gasket as shown.



87. Install OEM Oil Cooler onto the spacer as shown. Re-install the nuts and bolt to mount the Oil Cooler to the spacer and **torque to 18 ft/lbs.**

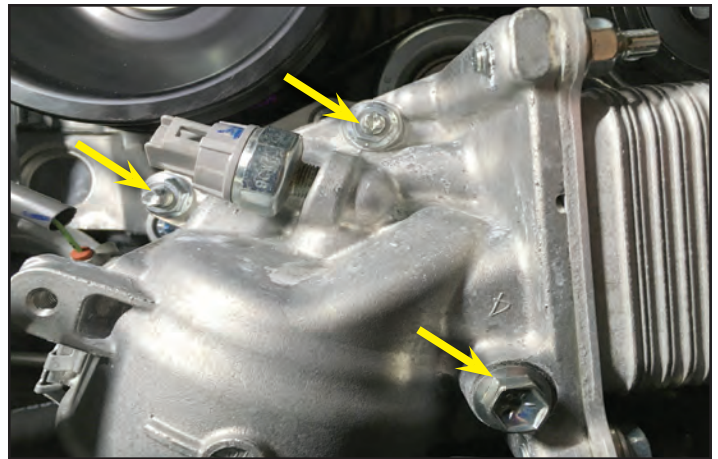

88. Re-install the bolt to retain the hardlines along with the electrical connector.



Section 6: Crank Pulley and Idler Bracket Installation

89. Gather the following provided pulley, washer and bolt.



90. Ensure that the dowel pin shown with the arrow lines up with the keyway in the crank pulley.



91. Remove the factory bolt at the crank pulley. This will require an impact gun. Discard the factory bolt and washer. Line up the dowel pin from the provided pulley with the keyway shown here with the arrow.



92. Using a strap wrench or other device to keep the crank from spinning install the provided bolt and washer from three steps ago by hand first and ensure that the dowel is lined up with the keyway and the pulley is flush with the crank. **Torque bolt in place to 204 ft-lbs. NOTE: It is recommended that you use an oil resistant silicone on the new crank bolt.**



93. Release the tension from the factory belt at the location shown with the arrow using a 14 mm socket wrench. Leave belt in place on tensioner but slip belt off the smooth idler near the power steering pump on passenger side.

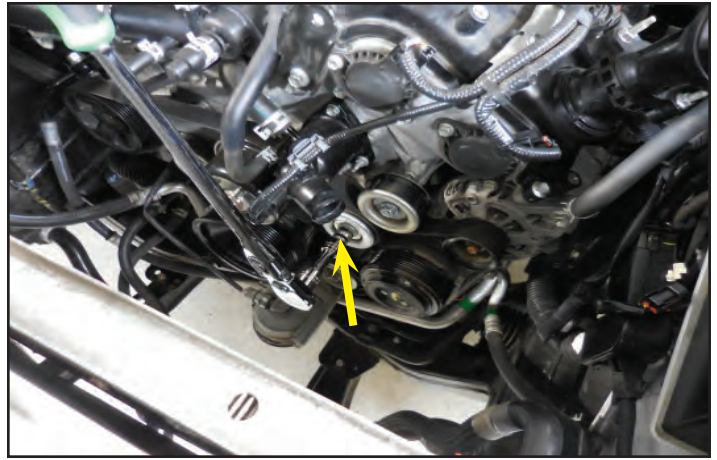

94. Remove the smooth idler shown with the yellow arrow using a 14 mm socket wrench. Remove the two bolts shown with green arrows using a 14 mm socket wrench. Remove the bolt shown with the red arrow using a 12 mm socket wrench.

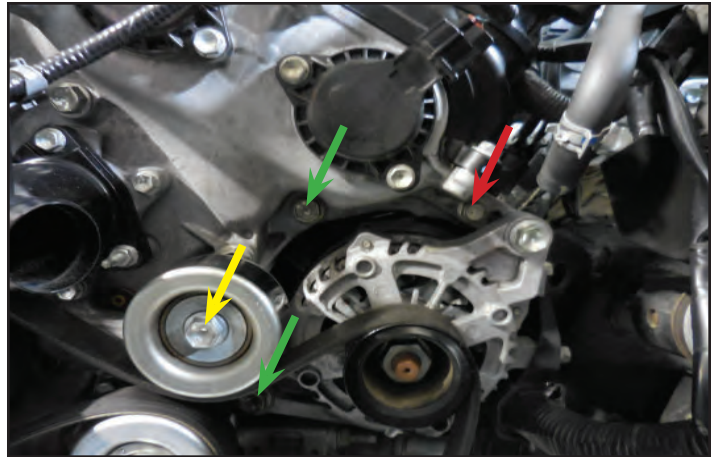

95. Here are the bolts and pulley that were removed in the last step. The bolts will not be reused, the pulley will.



96. Gather the following provided pulleys, brackets, tensioner, spacers and bolts. Consult the back of this manual for an exploded view of this assembly.



97. Install the tensioner spacer with the two provided flat head Allen bolts in the orientation shown. Ensure that the hole shown with the arrow is pointing in the correct direction. This hole will line up with the tensioner assembly in a later step.

Torque the two flat head bolts to 108 in-lbs.

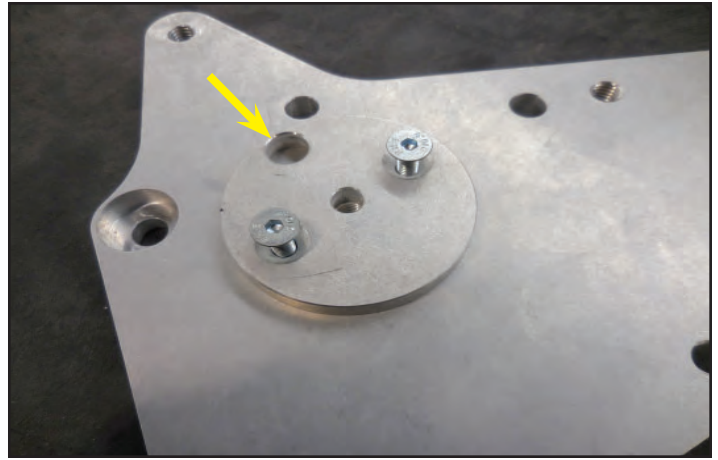

98. Gather the M10x65mm with 11mm spacer, M10x100mm bolt with 54mm spacer, and the OEM smooth pulley that was just removed. **Apply blue Loctite 242 to the two bolts.**

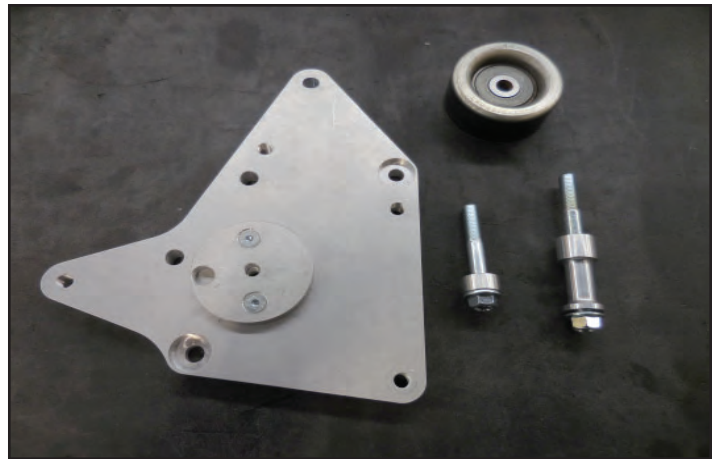

99. Install the M10x65mm bolt from the last photo into the hole shown here.



100. Install the 11mm spacer on the opposite side.

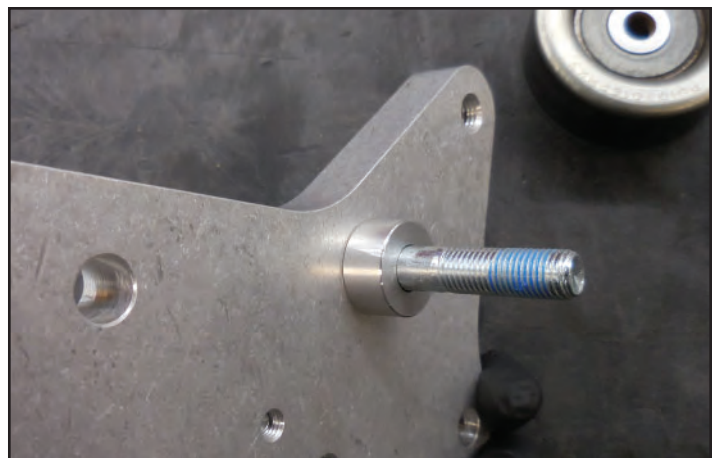

101. Follow the spacer with the OEM pulley facing in the direction shown.

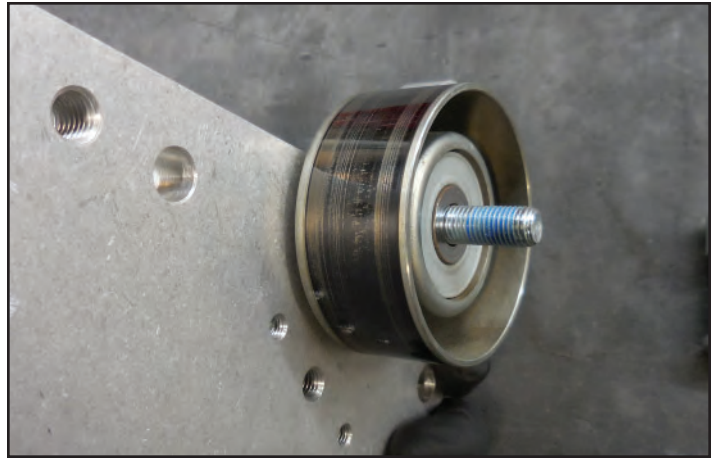

102. Install the M10x100mm bolt with the 54mm spacer oriented as shown next to the pulley.



103. Install the smooth pulley back in its original location. The lower bolt goes into the lower alternator location. Make sure the bolt sits under the pulley and does not get hung up. Loosely tighten enough to keep everything in place. **NOTE: Make sure that the belt is properly positioned on the tensioner and the smooth idler just reinstalled.**



104. Gather the 74mm spacer, M10x120mm bolt, M8x130mm bolt, and 64mm spacer shown. **Apply blue Loctite 242 to the two bolts.**

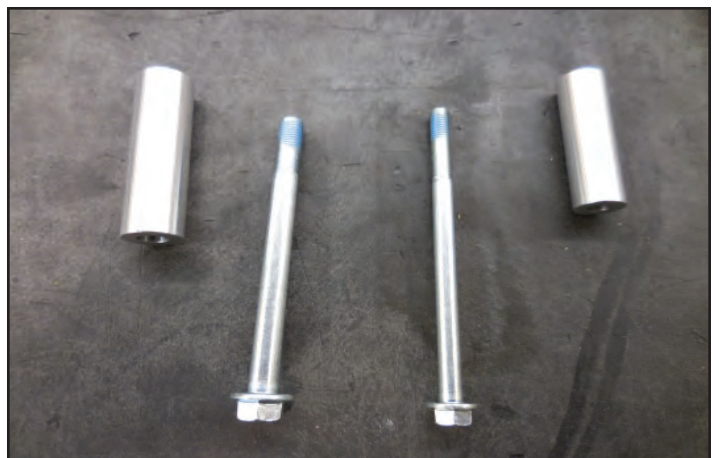

105. Insert the M10x120mm bolt with the 14 mm head and the 74mm spacer in the arrow locations.

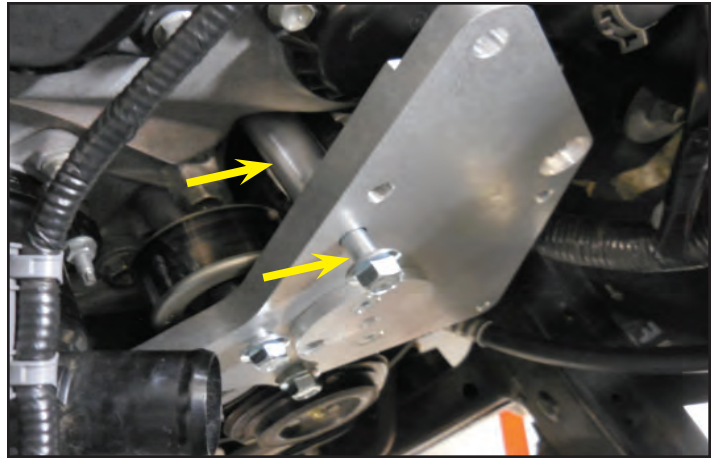

106. Insert the M8x130mm bolt with the 12 mm head the and 64mm spacer in the arrow locations.

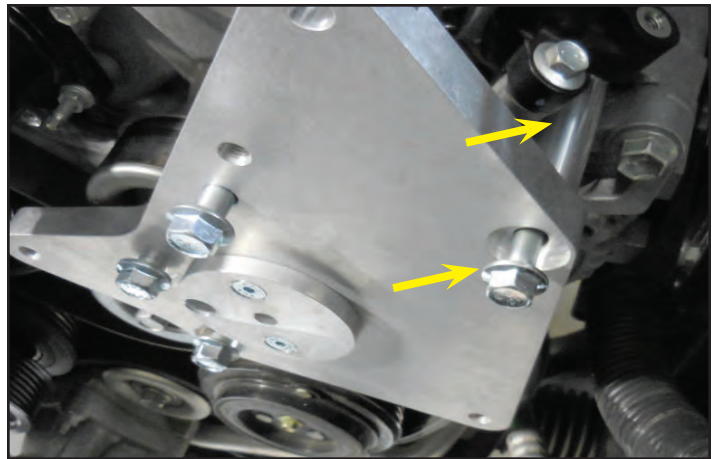

107. Snug all bolts by hand first. **Torque the three M10 bolts shown with the red arrows to 25 ft-lbs. Torque the M8 bolt shown at the yellow arrow location to 18 ft-lbs.**

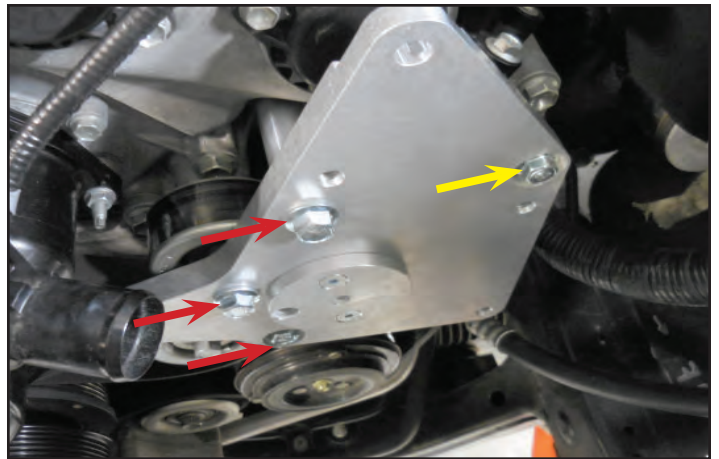

108. Rotate the tensioner to allow the factory belt to be reinstalled back onto the smooth idler of the power steering pump.



109. Ensure that the belt is centered on all the factory pulleys.

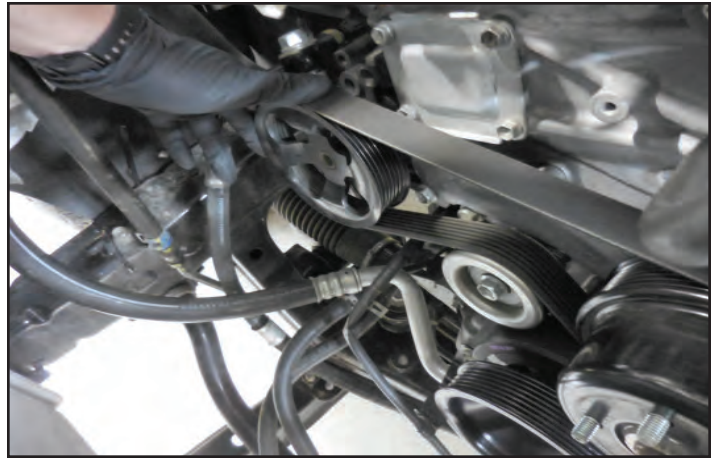

110. Gather the idler pulleys, spacers, and bolts shown. Bearing color may vary from pictures. **Apply blue Loctite 242 to the 4 bolts.**

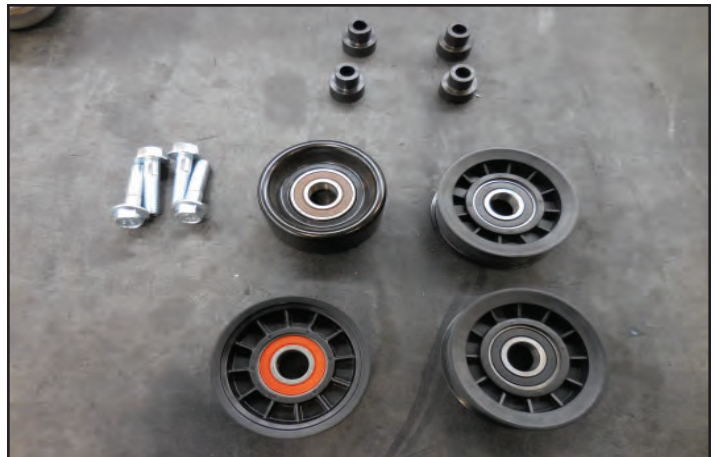

111. Insert the spacers into the back sides of all the idler pulleys.



112. Insert the bolts through the opposite side of the spacer. **Apply blue Loctite 242 to the threads of the 4 bolts (as shown in picture).**



113. **Ensure that the bolts have blue Loctite 242 applied to them.** Install the pulleys in the locations shown with the arrows. Ensure that the smooth pulley is located at the top and facing the direction shown at the yellow arrow location, and the ribbed pulleys are at the green arrow locations with the spacers at the back of all pulleys. **Torque all locations to 25 ft-lbs.**

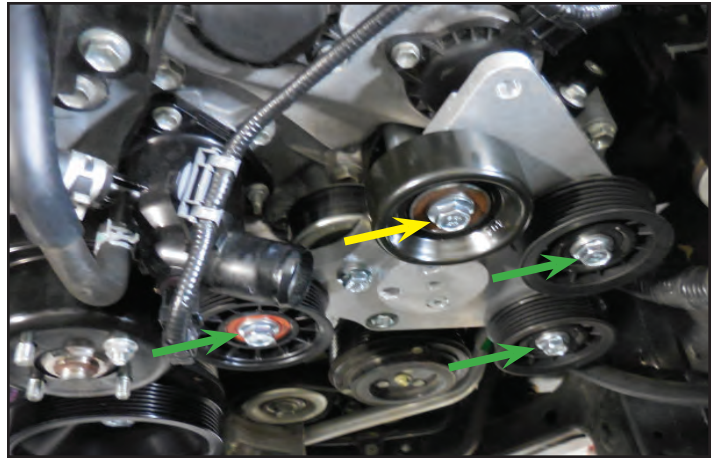

Section 7: Harness and Hose Rerouting

114. Remove the retainer holding the cam wiring harness at the red arrow location with a 10 mm socket wrench. Remove the bolt holding the bracket on the cam cover at the yellow arrow location. Release the other wiring harness strap at the back of the bracket on the underside of the green arrow location and remove it from the vehicle.



115. The bolt and bracket just removed will not be reused.



116. Gather the stud and cable tie shown. **Apply Loctite 242 to the stud.**



117. **Ensure that stud has blue Loctite 242 applied to it.** Install the stud in the arrow location. Also remove the two cable ties that were holding these two harnesses together.

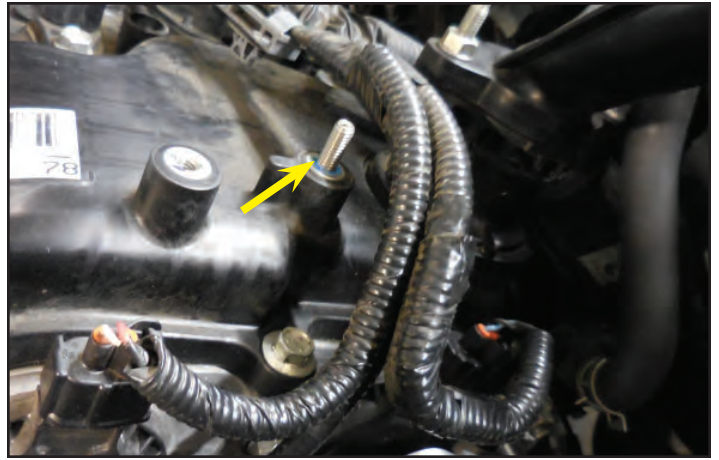

118. Install a cable tie at the yellow arrow location that will allow the two cable harnesses to be pulled out of the way of the belt line, and close to the bolt on the cam cover shown with the red arrow. Install the cable tie from two steps ago at the green arrow location and use it to pull the harnesses back away from the belt line.

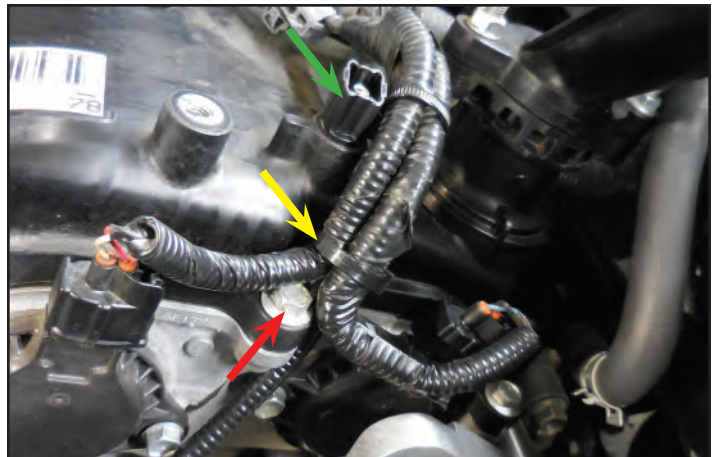

119. Remove the OEM hose shown. The spring clamps will be reused. Discard this hose and save the spring clamps for the hose in the next step.



120. Route the supplied hose from the last step as shown and connect to the original location with the OEM spring clamp.



121. Find the connector shown that was originally plugged into the back of the manifold.



122. Wrap the connector end in electrical tape and secure it in the location shown with a provided cable tie.



123. Reinstall the OEM stud using an E6 external Torx driver until it bottoms out. Then install the OEM nut shown that was removed earlier and **torque the nut to 90 in-lbs.**



Section 8: LTR and Pump Installation

124. Unplug the ambient air connector shown.



125. Unplug the connection shown at the bottom of the hood support bracket and un-clip the anchor holding it in place.



126. Un-clip the anchor on the other side as well.



127. **For vehicles with a transmission cooler** un-clip the last anchor shown with a yellow arrow.

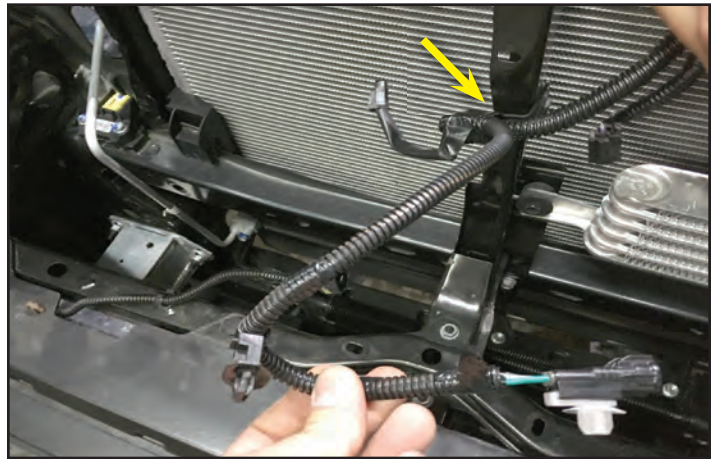

128. Secure the wire harness that was just unplugged to the side as shown at the arrow location.

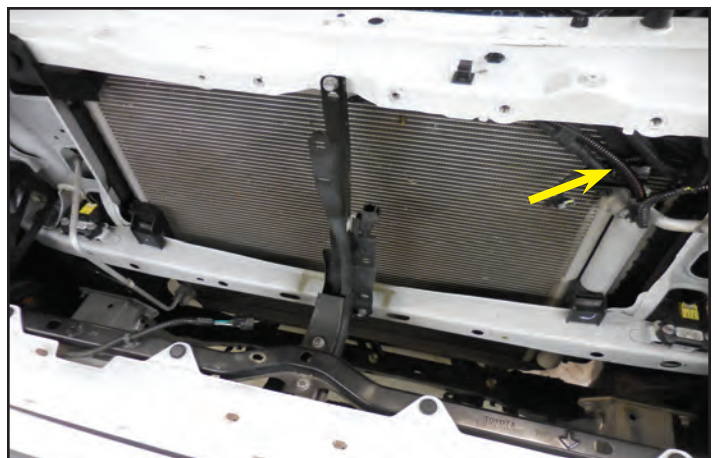

129. Remove the two bolts and two nuts shown at the arrow using a 10 mm socket wrench and remove the bracket.



130. **For vehicles with a transmission cooler** you will also need to remove two bolts shown with red arrows. Loosen the bolt with the yellow arrow to allow the cooler to rotate forward. This will allow the Low Temp Radiator to be installed behind the transmission cooler in the following steps.

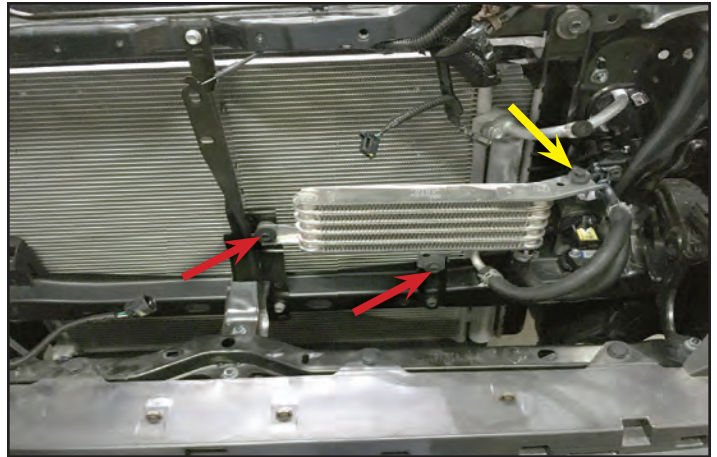

131. Remove the two bolts in the arrow locations with a 10 mm socket wrench. These bolts will not be reused.

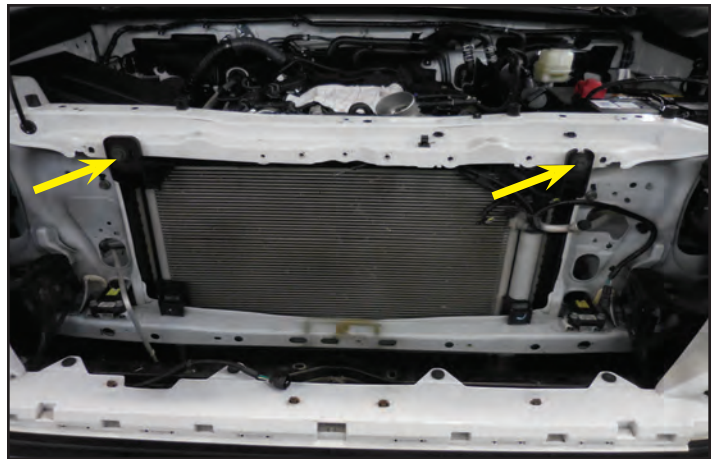

132. Unbox the “Low Temperature Radiator” (LTR).



133. Gather two of the grommets shown. Evenly squeeze the sides together with pliers on both grommets. The grommet on left is unmodified and the one on the right has been squashed. This will allow it to clamp tighter on the sheet metal.



134. Insert the two grommets into the locations at the bottom of the LTR. You can see that the shorter side of the grommet goes to the shorter side of the bracket shown with the arrow.

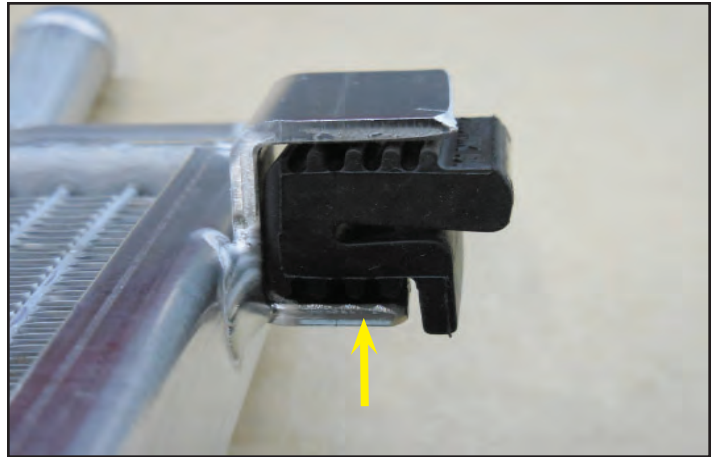

135. Insert the upper left corner of the LTR with the spigot into the location shown with the arrow.

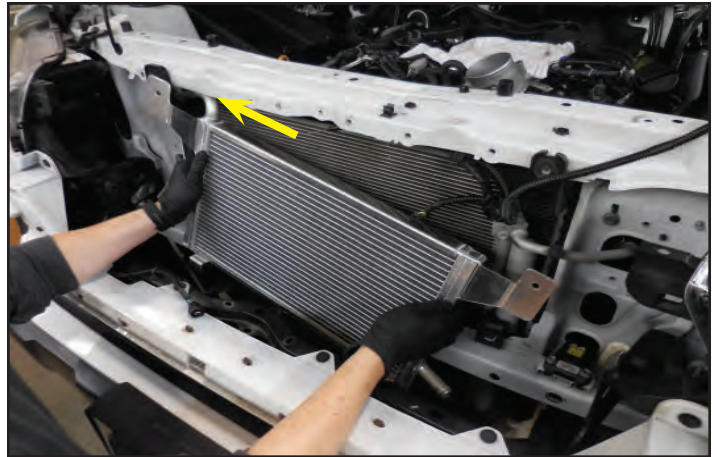

136. Here is a close-up of the spigot going in front of the radiator fill location.



137. Ensure that the two grommets align with the sheet metal shown at the arrow locations. At this point you can also install the hood support bracket again as seen here.

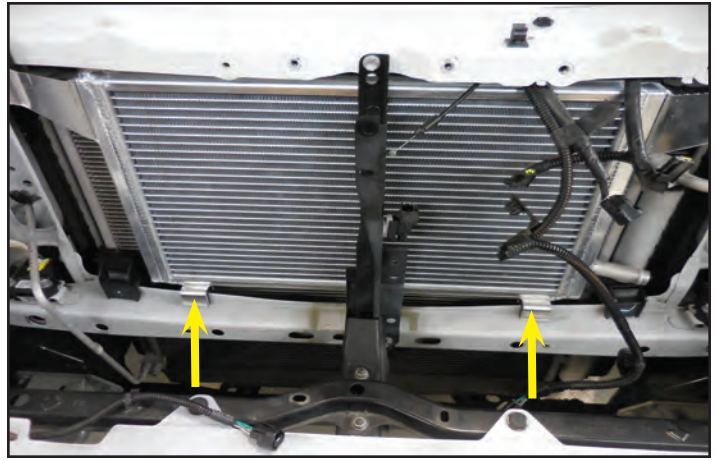

138. **For vehicles with a transmission cooler** install the hood support and oil cooler fasteners (Red arrows). Make sure to re-tighten the bolt with the yellow arrow also.

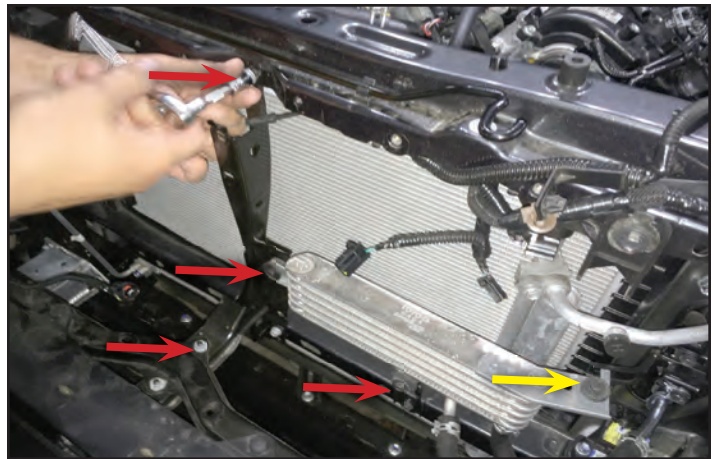

139. **Torque the hood support bracket to 108 in-lbs using a 10 mm socket wrench at 4 locations.**



140. Install the two provided washers on the two provided M6x30mm bolts and **apply blue Loctite 242 to them.**



141. Install one of the bolts with a washer from the last step at the location shown. Install the second bolt and washer on the opposite side of the LTR.
Torque both bolts to 50 in-lbs.



142. Reconnect all the electrical harnesses on the hood support bracket.



143. Apply blue Loctite 242 to the provided M6x20mm bolt and install the provided intercooler pump bracket in the location shown. For vehicles with trans cooler this bracket will sit behind OE bracket, and bolt will not be needed, reuse OEM bolt in that case. **Torque the bolt holding the pump bracket to 108 in-lbs.**



144. For vehicles with a Transmission Cooler install the bracket under the bracket for the Trans Cooler mount as shown.

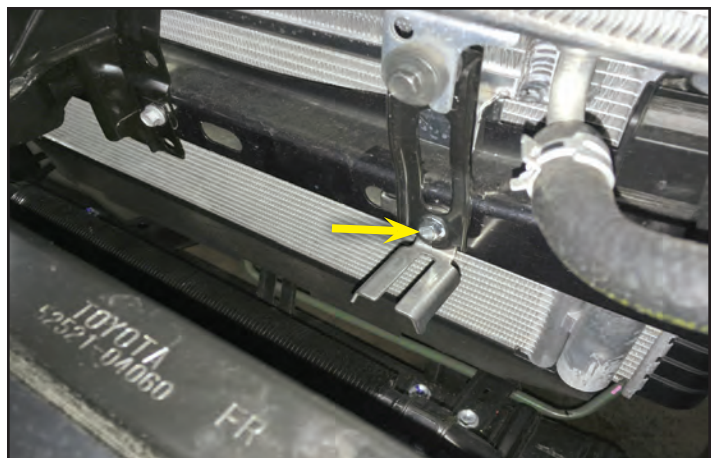

145. Install the provided rubber isolator to the pump so the raised portion (highlighted in green) is facing towards the output hose barb. Remove the red caps from the pump at this time.



146. Install the rubber isolator with the pump on the bracket that was installed earlier.

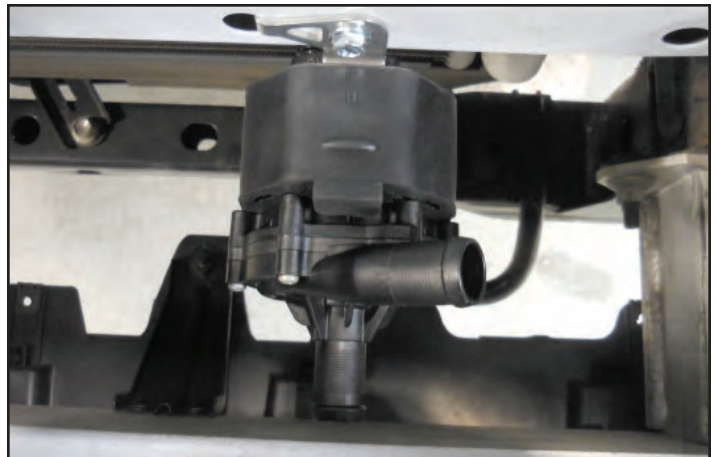

Section 9: Pump Electrical Connection

147. Gather the intercooler pump wiring harness.



148. Route the "T" intersection of the wiring harness near the battery and route the ground wire near the battery ground.



149. Route the ground wire under the positive battery cable as shown highlighted in green here. Remove the bolt at the arrow location using a 10mm socket and place the eyelet from the ground on the intercooler pump harness on top of the OEM ground wire and fasten them both with the OEM bolt and tighten in place. **Torque the OEM bolt to 108 in-lbs.** Remove the fuse box lid.

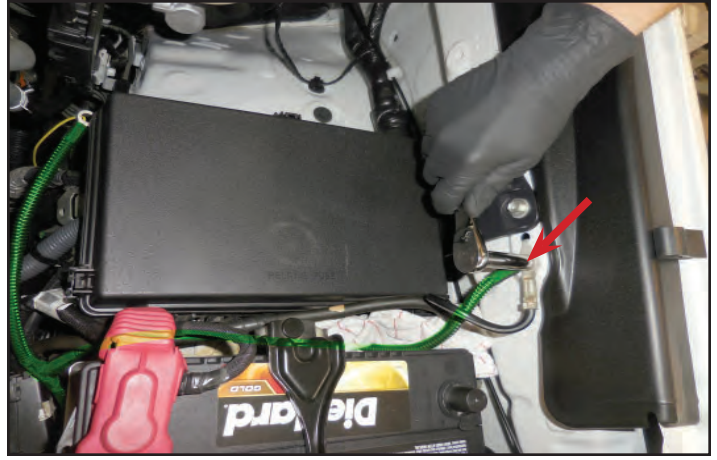

150. Remove the nut shown at the arrow location using a wrench using a 10 mm socket wrench. Use a magnet to extract the nut.



151. Pull up on the cable cover shown with the yellow arrow as you are releasing the locking tab at the red arrow location with a small screwdriver.



152. Remove the electrical tape in the green highlighted area.

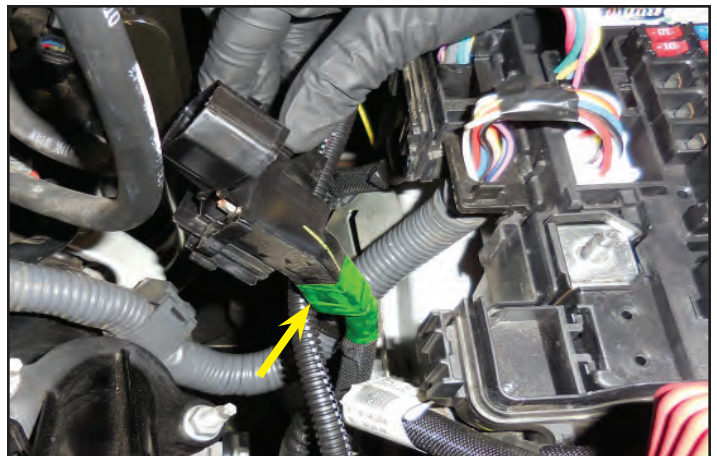

153. Once you have removed the electrical tape you will have access to the wire shown.



154. Mark the wire loom of the power supply end on the intercooler harness 5" from the eyelet terminal. This is the wire loom with the yellow trigger wire. Carefully trim the wire loom off these two wires at the green highlighted area without cutting the wires.



155. Run the power cable and yellow trigger wire from the last step into the cable cover as shown. Clean the cable cover and wire loom to prepare it for electrical tape application.



156. Cut off about 12" of electrical tape. Wrap the electrical tape around the cable cover and wire loom at the green highlighted area shown with an arrow.



157. Connect the red wire eyelet terminal from the intercooler harness to the stud shown with the arrow.

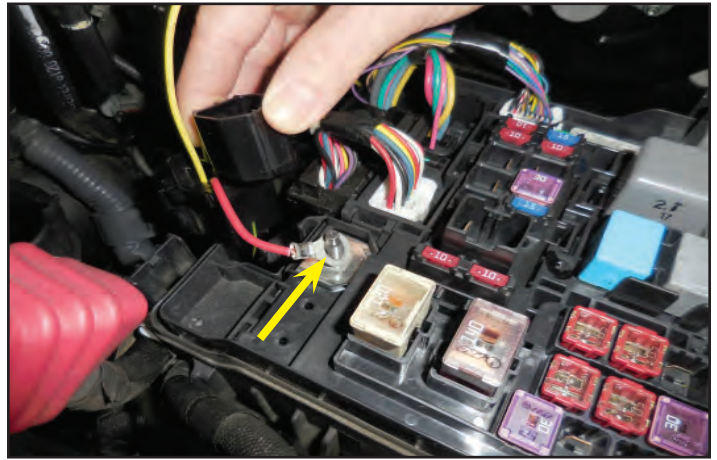

158. Reinstall the cable cover and power terminal over the red wire eyelet terminal. Ensure that terminal on the red wire is facing towards the corner as shown here with the arrow.

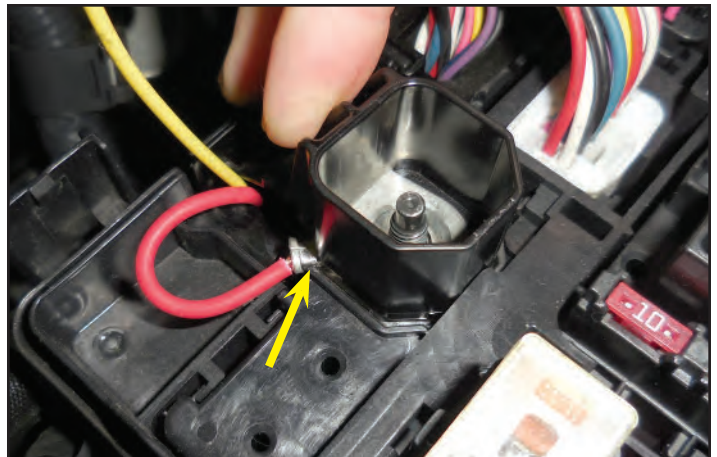

159. Ensure that the eyelet is at the corner to ensure that the two terminals sit flush with each other. Reinstall the nut to the stud.



160. **Torque the nut to 90 in-lbs.**



161. Remove the 10 Amp "INJ" fuse at the arrow location. This fuse will be replaced with a provided one in the next steps.

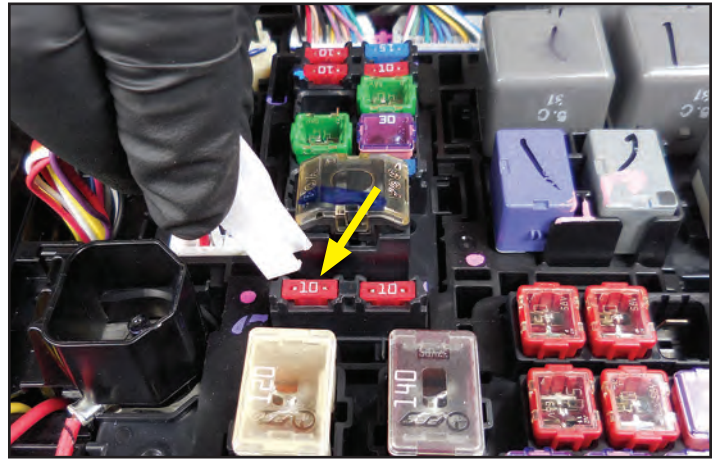

162. Install the yellow trigger wire tap onto the provided 10 Amp fuse as shown.

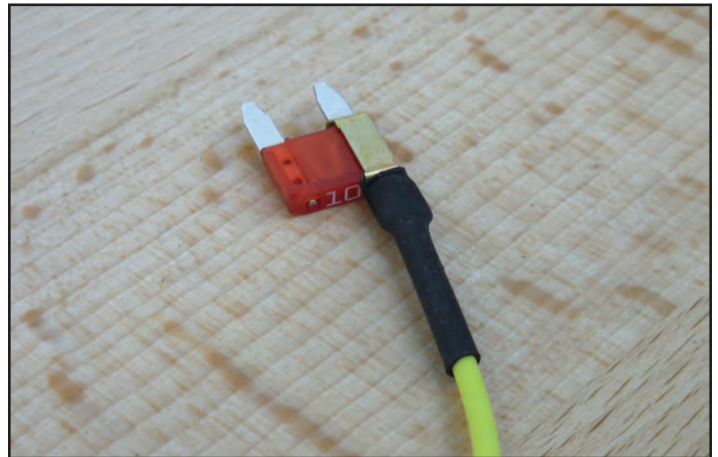

163. Install the 10 Amp fuse from the last step into the location the OEM 10 Amp fuse was. Ensure that the wire goes to the right side as shown with the arrow. Route the yellow trigger wire in the location shown here. Install the fuse box cover making sure that none of the added components interfere and that it latches in place.

NOTE: The new fuse will stick up approximately 5mm when properly installed.

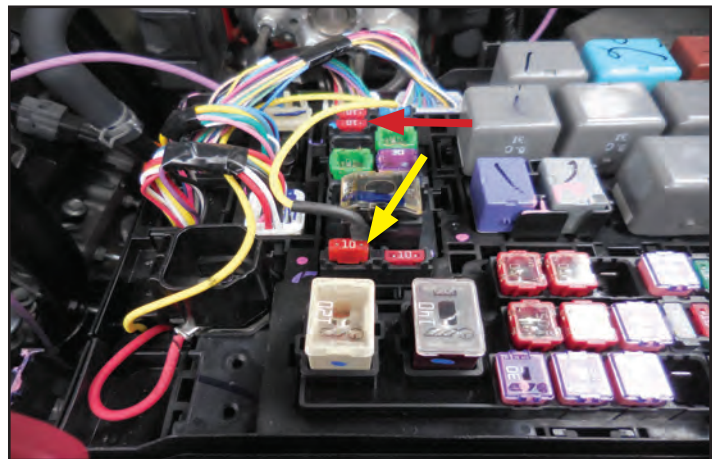

164. Neatly organize the "T" intersection from the intercooler pump harness as shown.



165. Install a cable tie at the location shown.



166. Open the fuse housing cover on the intercooler wiring harness and install the provided 15 Amp fuse. Reinstall the fuse housing cover.



167. Locate the intercooler pump relay shown in the flat sheet metal area in front of the battery and below the headlight assembly. This will be secured with a cable tie shown in the next step.



168. Gather the provided edge mount cable tie shown below. Attach the edge mount on the sheet metal at the arrow location and wrap the cable tie around the intercooler relay location as shown.



169. Use a provided cable tie to secure the intercooler pump fuse housing in arrow location.

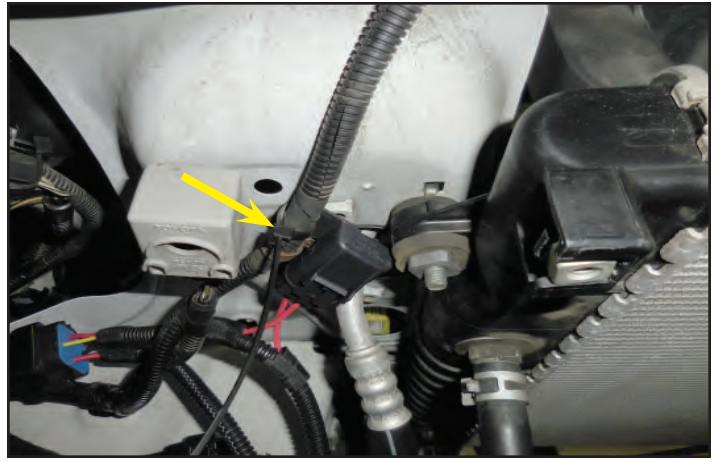

170. Route the intercooler pump connection next to the radiator at the arrow location.



171. Here is the pump connection pulled through and near the bumper. Continue to pull all this wire through until all the slack has been relieved.



172. Secure the wire harness at the two locations with provided cable ties.

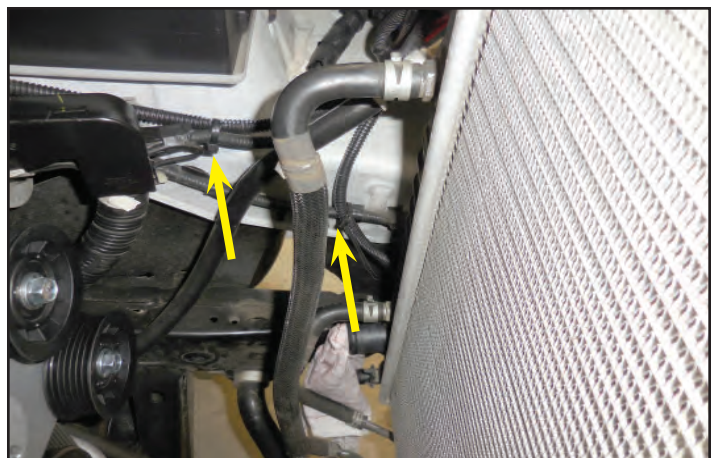

173. Plug the coolant pump connection into the pump. The pump is shown removed from the bracket to allow visibility of the connection.



174. Route the excess wire towards the drivers side headlight. Install a tie wrap at the arrow location.



175. Wrap the excess wire up as shown and secure it with a provided cable tie.



176. Stow the excess wiring loom behind the bumper support and secure it with a cable tie in the arrow location.



Section 10: Coolant Hose Routing

177. Gather the provided hose and spring clamps. Connect the long leg of the hose to the output side of the coolant pump and the short leg to the lower barb of the LTR and secure with the provided hose clamps.

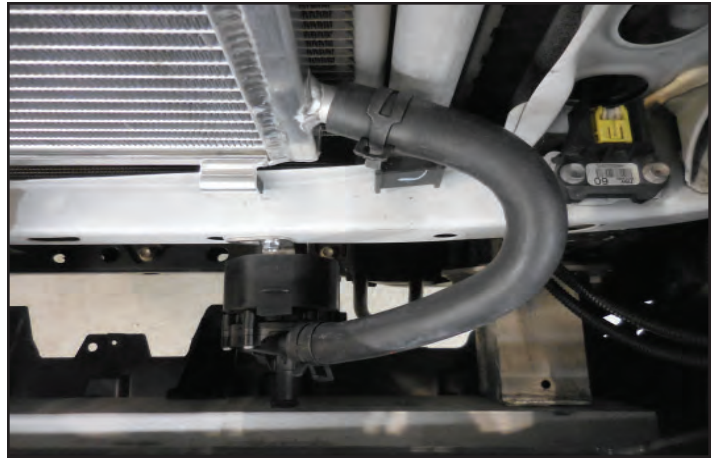

178. Gather the hose assembly shown. The yellow arrow shows the side that will attach to the intercooler pump. The red arrow side will be fed into the engine bay in the next step.

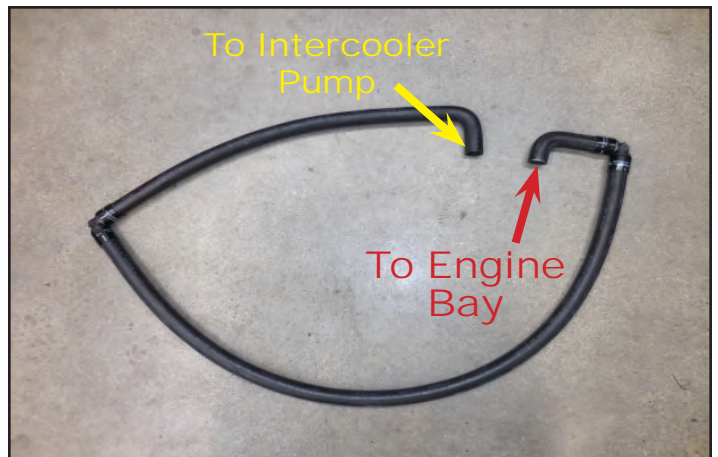

179. Feed the red arrow side of the hose assembly from the last step through into the engine bay. The other side goes to the intercooler pump.



180. Continue to feed the hose through into the right side of the engine compartment as shown highlighted in green.



181. Connect the end of the hose assembly from the last step to the input of the pump and secure with a spring clamp. The hose will lay along the bumper support as shown.

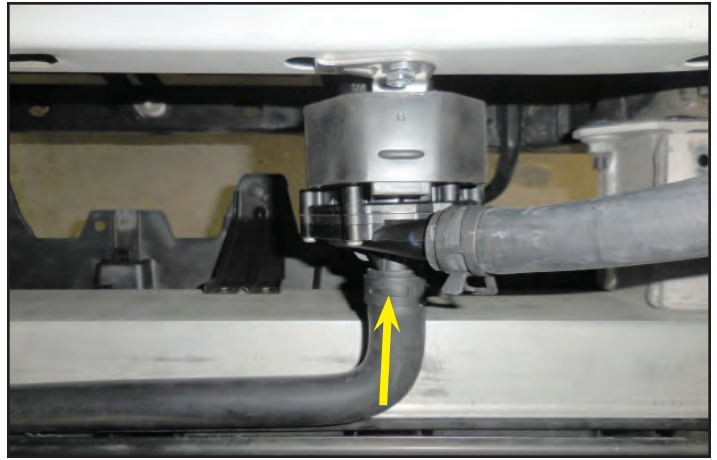

182. Secure the hose assembly from the last step to the a/c hardline near the dipstick using two provided cable ties at the arrow locations. These cable ties have been highlighted in green for clarity. **Do not crush the hose.**

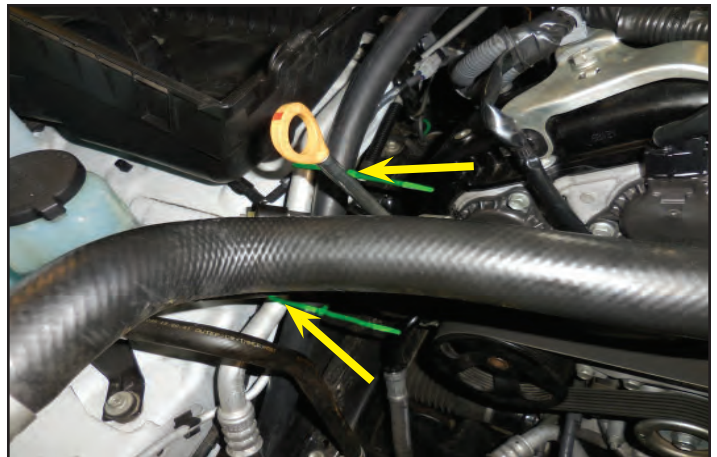

183. Gather the provided cable tie and swivel connector shown below. Slide the swivel onto the cable tie as shown below. Insert the cable tie with the swivel from the last step between the hose and hardline as shown. Secure the swivel clamp in the location shown and trim the cable tie. **Do not crush the hose.**

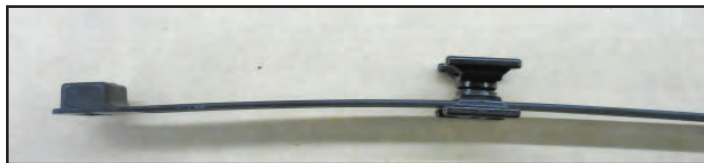
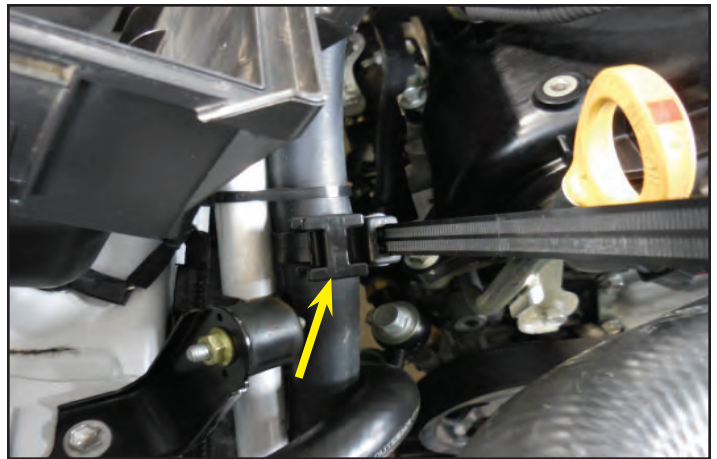

184. Gather the hose shown.



185. Install the hose from the last step at the upper LTR barb with a provided spring clamp. The short leg gets attached to the barb, long leg will aim down alongside of radiator.

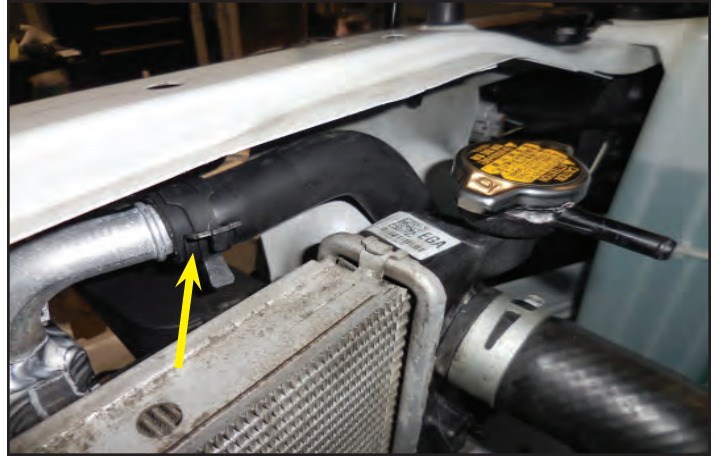

186. Route the hose from the last step under the power steering hose as shown.



187. Trim the OEM PCV hose (passenger side) as shown.

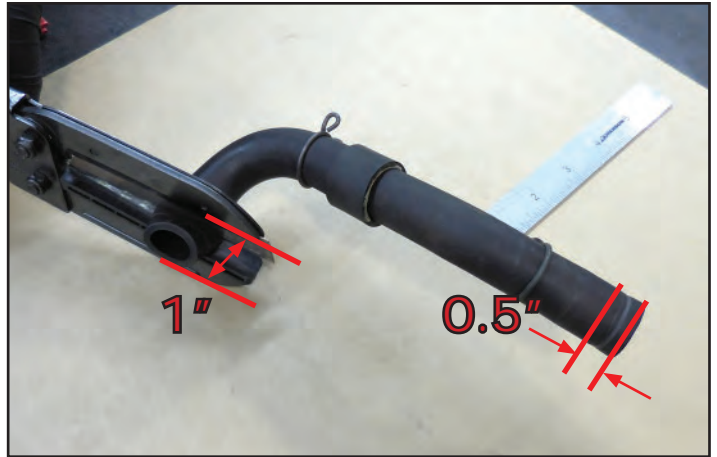

188. Install the hose from the last step in the arrow location and secure with one of the OEM spring clamps.

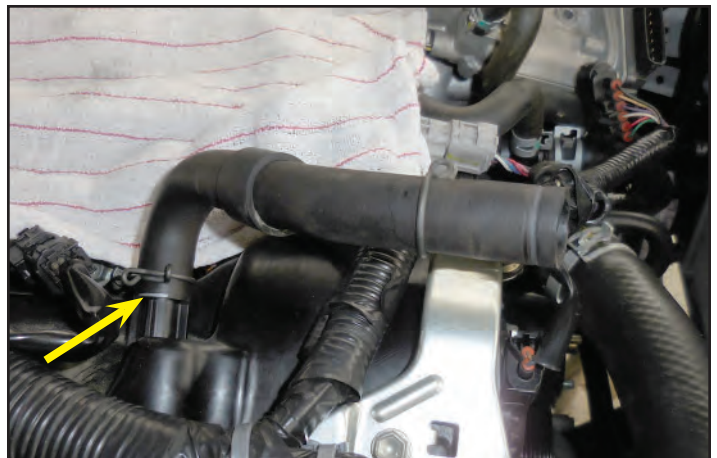

189. Remove the factory throttle gasket from the intake manifold shown with the arrow. Also remove the other parts shown from the intake manifold. These will be used again.



Section 11: Supercharger Preparation and Installation

190. Gather the upper intake manifold shown. Remove the 4 bolts holding the charge air cooler (CAC) manifold using a 10 mm socket wrench.

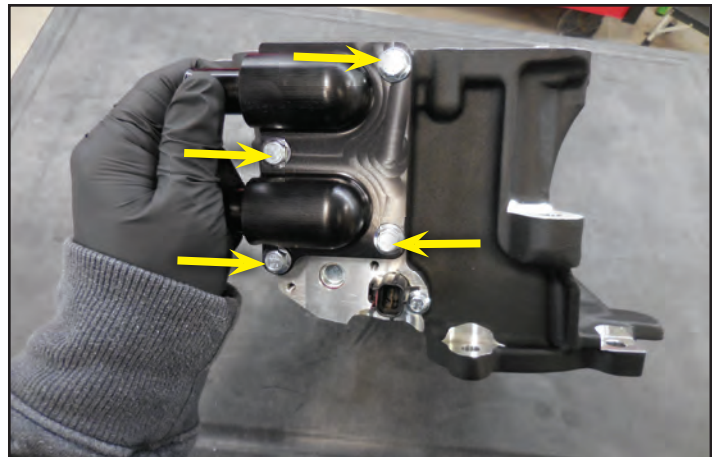

191. If you are adding a Boost gauge. Remove the 1/8" NPT plug from the rear of the Upper Intake Manifold and install the appropriate fitting. (not supplied) We recommend a 90 degree fitting for this application because of the tight condition to the factory wire harness.

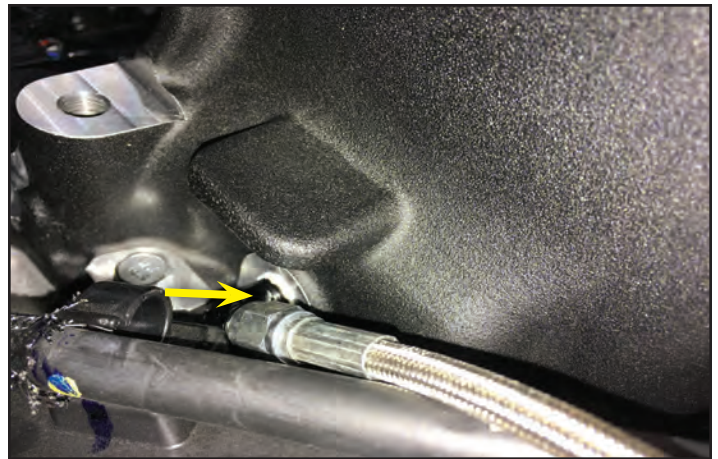

192. Protect the O-rings from any contamination or damage. These will need to be relubed for this assembly when it is reinstalled.



193. Remove the 10 bolts holding the CAC in place with an 8mm socket wrench. Ensure that you do not damage the CAC as you set it aside.

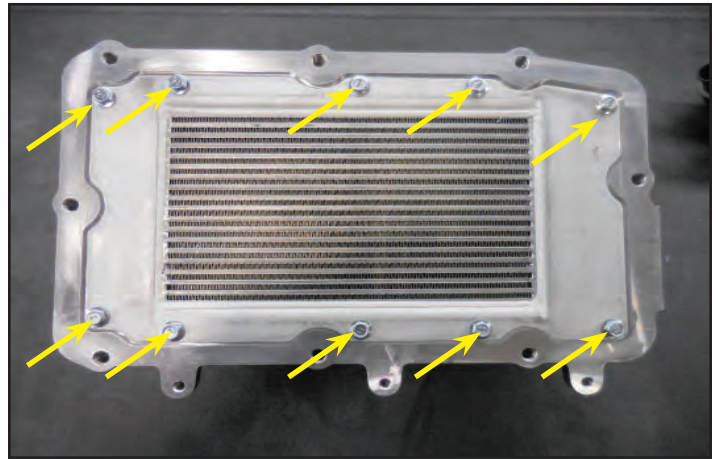

194. Inspect the O-ring on the top of the lower intake manifold. Ensure that the surface is clean and free of any damage.



195. Gather the following eight M8x30mm bolts and **apply blue Loctite 242** to them. **Do not** use the dished head bolts shown below for this.



196. Install the upper manifold onto the lower manifold using the bolts from the last step and a 12 mm socket wrench.



197. Two of these bolts go inside at the arrow locations.

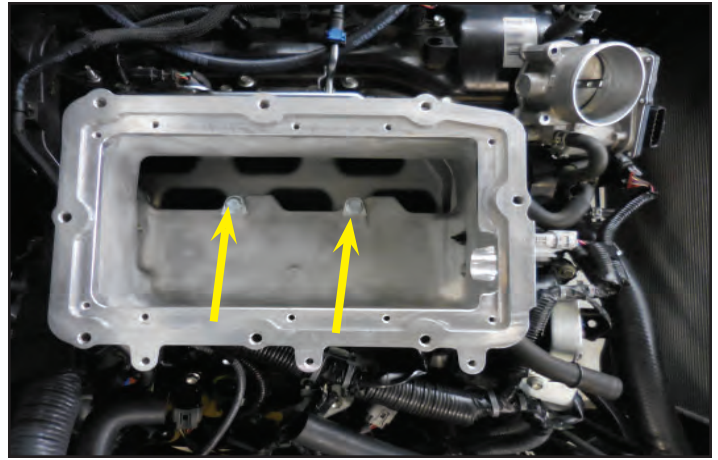

198. **Torque these bolts to 18 ft-lbs.** following the sequence shown. There is a larger version of this diagram at the back of this manual.

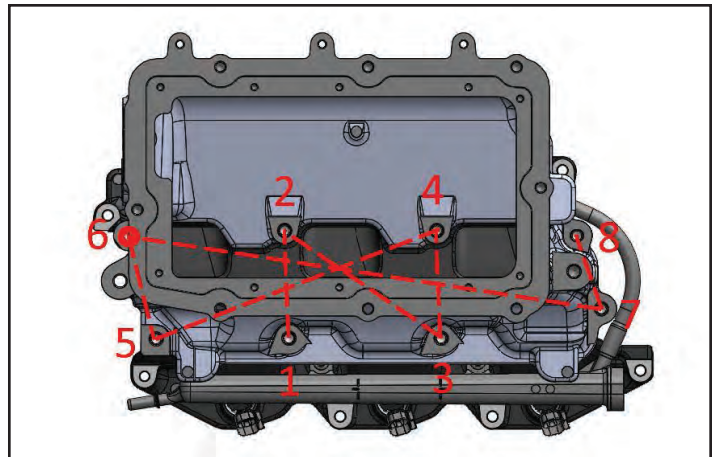

199. Gather the ten M8 CAC bolts that were removed earlier and apply blue Loctite 242 to them as shown below. Use the ten M8 bolts to reinstall the CAC with an 8mm socket wrench and **torque them to 90 in-lbs.**



200. Gather the CAC manifold with tubes installed, and the 4 bolts that were removed earlier. **Apply blue Loctite 242 to the bolts. Also apply a light coat of provided Lubriplate grease to the O-rings on the tubes and manifold shown with arrows.**



201. Press the manifold evenly to ensure that the O-rings go in straight.



202. **Torque the 4 bolts to 108 in-lbs using a 10 mm socket wrench.**

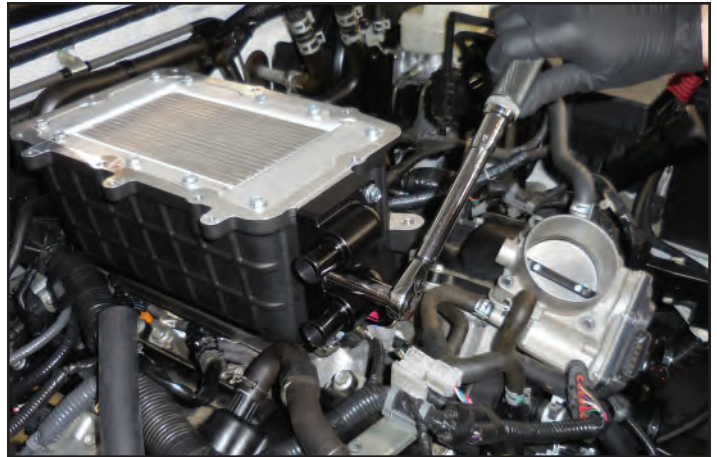

203. Apply blue Loctite 242 to the two M10 bolts shown below. They will be used to install the supercharger in the next steps. Have someone help you locate the supercharger next to the upper intake manifold.



204. While the other person is helping to hold the supercharger locate one of the bolts from two steps ago in the location shown with the arrow.



205. Locate the second M10 bolt at the back of the supercharger.

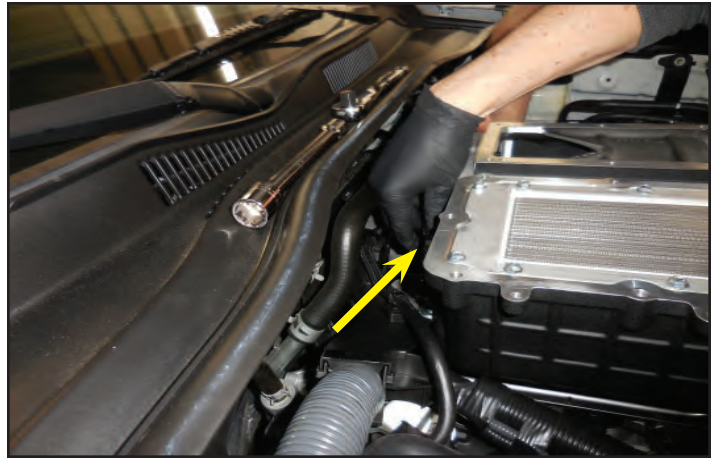

206. Tighten the two M10 bolts securely with a 15mm socket wrench while the supercharger is being supported by another person. Make sure both bolts go in evenly.



207. **Torque the two M10 bolts that were just installed to 33 ft-lbs.**



208. Remove the bracket that is highlighted in green from the hose at the back of the firewall. This should un-clip from the hose mount and will not be reused.



209. Clean the sealing surface of the supercharger and upper intake manifold with lacquer thinner. Ensure that there are no imperfections in the sealing surface.



210. Remove the lid from the bag and check the gaskets for any imperfections.



211. These three circled M8 x 16mm bolts are pre installed. **All the lid bolts will have the dished heads shown below.**



212. Lid fastener layout:
 Three M8x16mm (FAUX-IN **YELLOW**)
 Ten M8x30mm (PERIMETER-IN **RED**)
 Two M8x45mm (FRONT CENTER-IN **GREEN**)
 Two M8x65mm (REAR CENTER-IN **BLUE**)

There is a larger version of this at the back of this manual.

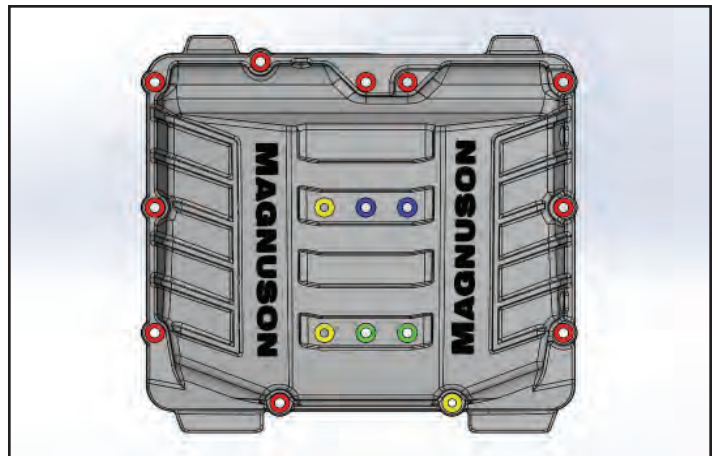

213. Apply blue Loctite 242 to all fasteners. Install lid fasteners hand tight. Then tighten both numeric (yellow) and alphabetical (red) sequence as shown in two cycles. **Tighten the first cycle, yellow and red to 8 ft-lbs. Then do another final cycle in sequence yellow and red at 18 ft-lbs.** There is a larger version of this in the back of this manual.

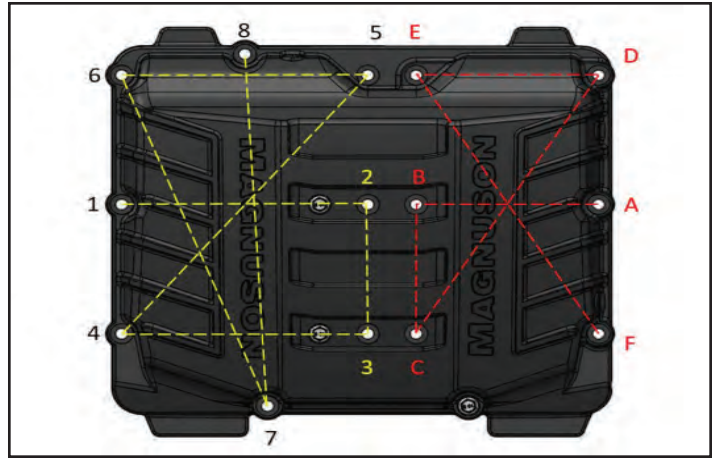

214. Gather the OEM throttle body bolts and gasket shown below. Install the gasket on the inlet of the supercharger at the arrow location.



215. Attach the OEM hoses to the throttle body as shown with the arrow to allow the throttle body to sit flush against the supercharger inlet without kinking this hose.



216. Install the throttle body with the OEM bolts using a 10 mm socket wrench and **torque to 108 in-lbs.**



217. Plug in the electrical connection to the throttle body.



218. Remove the supercharger pulley using a strap wrench and a 10 mm socket wrench.



219. Gather the following brackets, bolts, and nuts.



220. **Apply blue Loctite 242 to the eight M8x20mm bolts shown below.** Install 4 bolts from the last step in the arrow locations on the front supercharger support bracket using a 12 mm socket wrench and **torque to 18 ft-lbs.**

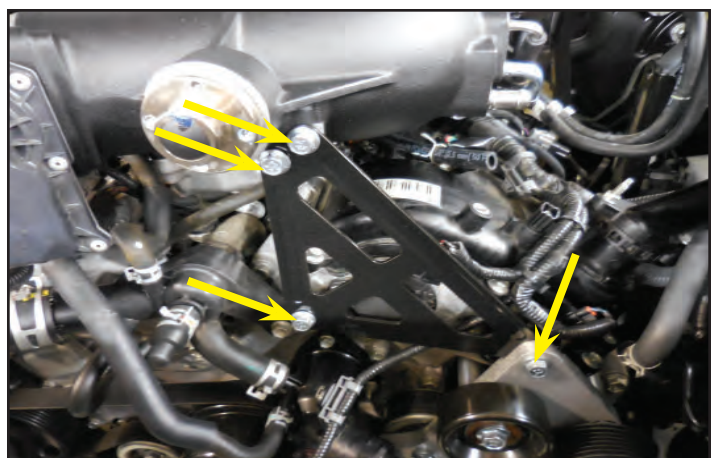

221. Locate the rear supercharger support bracket where shown on the left side of the supercharger.



222. Loosely install two of the M8 bolts at the yellow arrow locations, and two M8 bolts with nuts at the green arrow locations. **Torque all 4 bolts to 18 ft-lbs.**

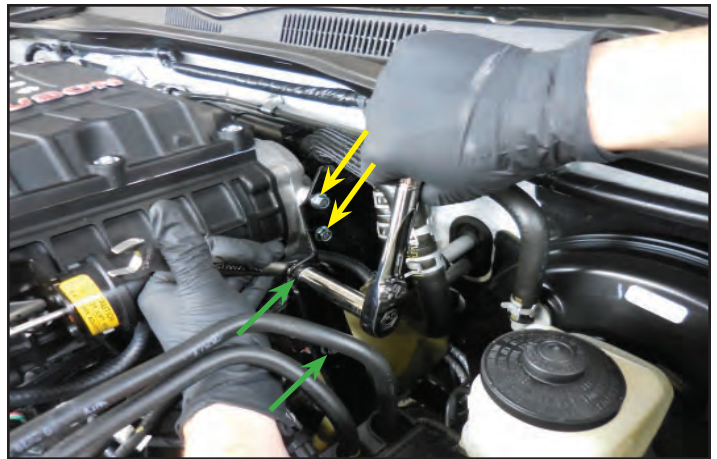

223. **For manual transmission trucks** replace the lower bolt from the last step with the clutch hose bracket with its built in stud and secure with provided M8 serrated flange nut shown at the arrow location.

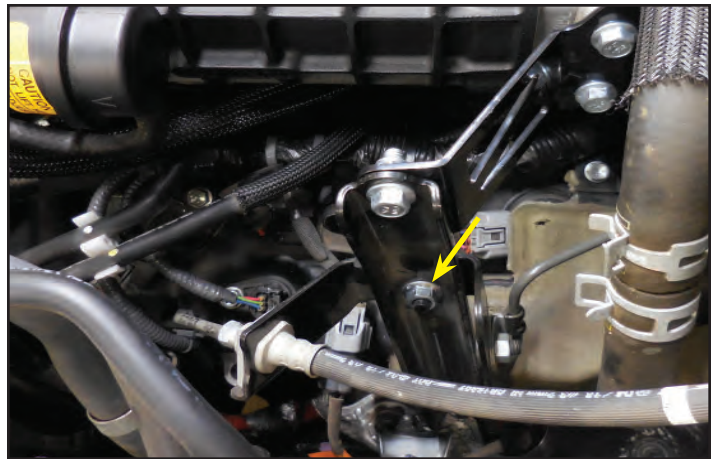

224. Connect the PCV line (highlighted in green) that was switched to the provided hose to the lower 90° hose barb at the supercharger inlet.

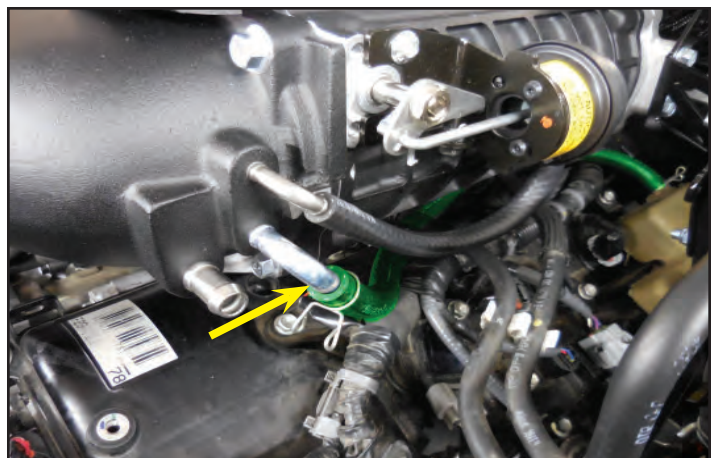

225. Reinstall the supercharger pulley with the 4 provided M6 bolts using a 10 mm socket wrench and **torque to 108 in-lbs.**



Section 12: EVAP Routing

226. Gather the following items. The parts on the left are provided in the kit, and the other parts were removed earlier.



227. Remove the hose clip shown. This will be used later.



228. Replace the hose clip from the last step with the one shown here.



229. Place the hose clip from the last step in the arrow location.

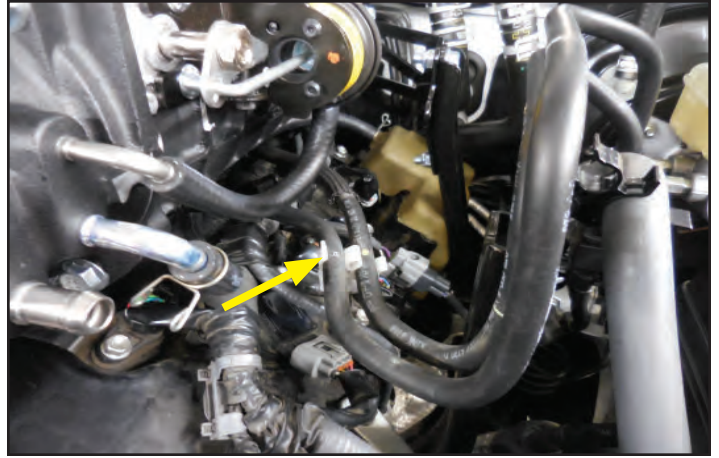

230. Install provided EVAP solenoid bracket with the provided bolt and nut that was shown 4 steps ago using a 10 mm socket wrench and **torque to 108 in-lbs.**

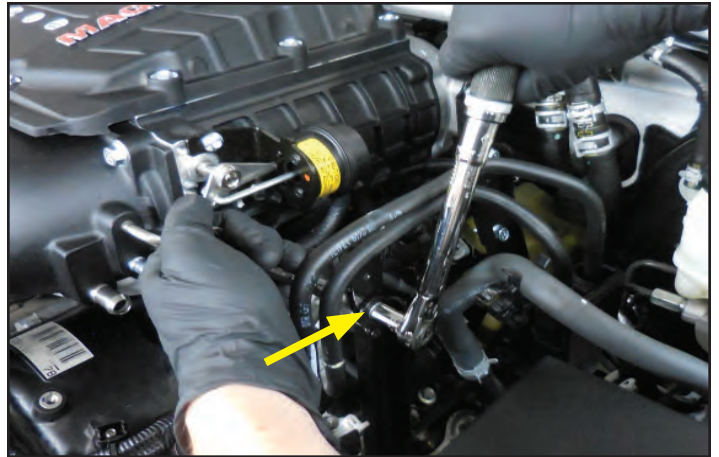

231. Use the OEM screw to install the EVAP solenoid to the bracket from the last step.

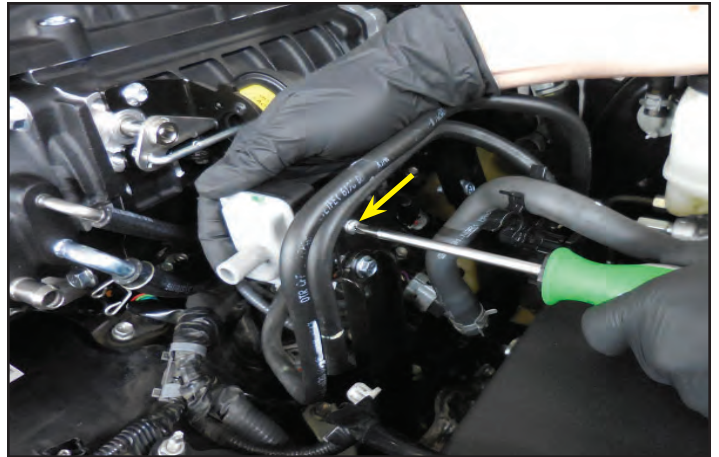

232. Install the highlighted hose at the EVAP solenoid at the red arrow location and secure with the OEM spring clamp. You may have to rotate the hose at the yellow arrow location to achieve this position without kinking the hose.

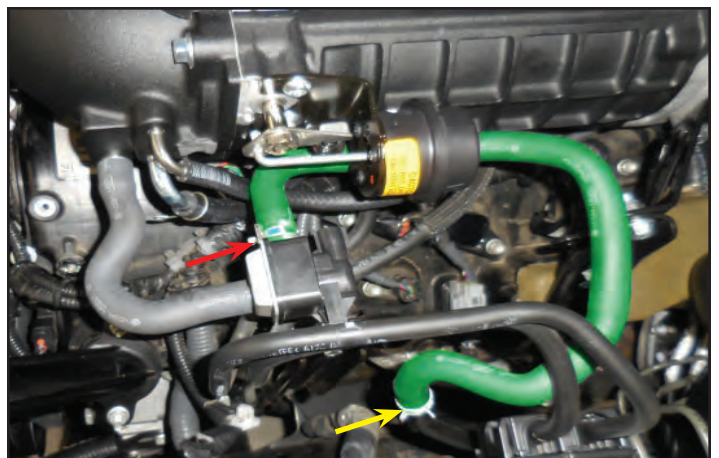

233. Cut 1.75" off the hose shown.



234. Install the hose from the last step between the supercharger inlet and the EVAP solenoid. Install the provided wire loom on the hose (highlighted in green) and swivel clamp at the yellow arrow location.

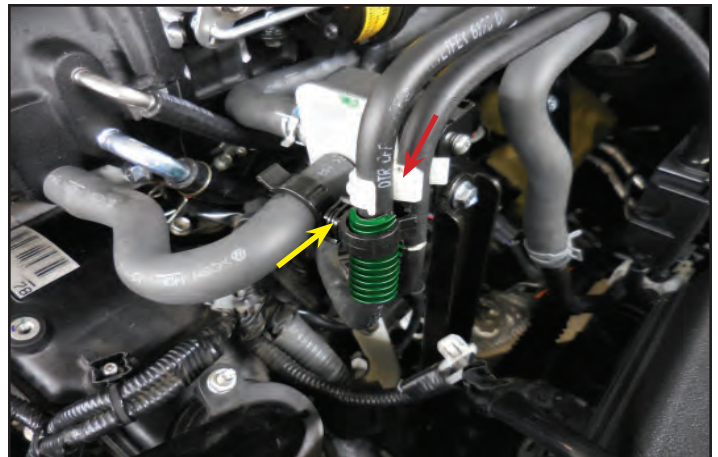

235. Plug in the electrical connection for the EVAP solenoid.



236. Gather the two provided cable ties shown below. Install one of the cable ties from the last step (highlighted in green) at the arrow location on the bracket and secure the hose shown with it. **Do not crush the hose.**



237. Install the other cable tie from the last step in the arrow location at the rear supercharger support. **Do not crush the hose.**

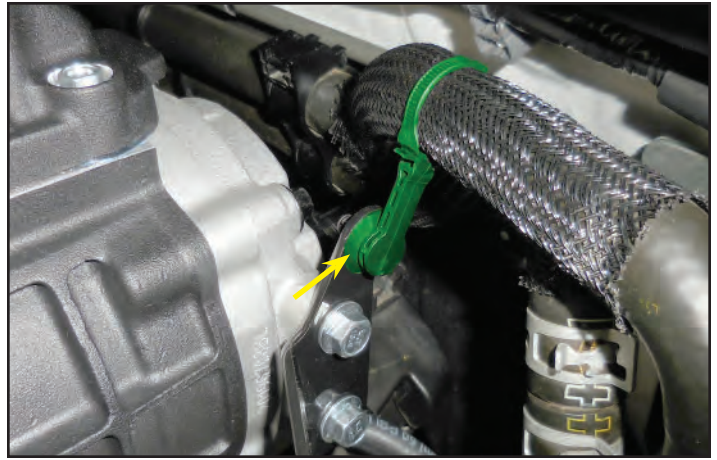

238. Insert the cable harness clip in the oval location of the EVAP bracket.

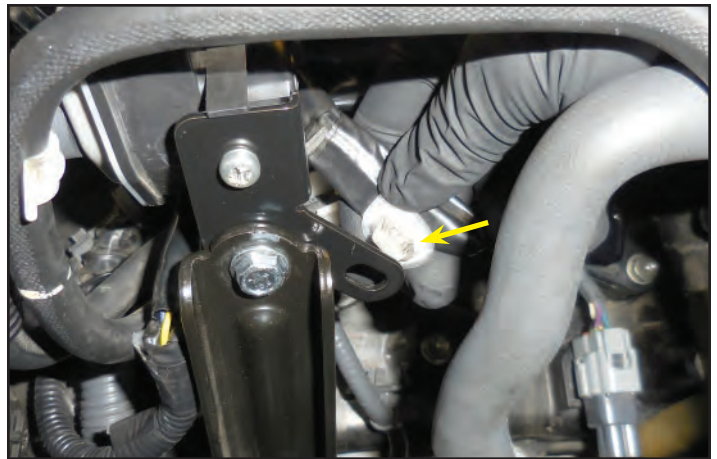

Section 13: Coolant Reservoir and Belt Installation

239. Gather the intercooler reservoir with cap and three M6x20mm bolts shown. **Apply Loctite 242 to the three bolts.**

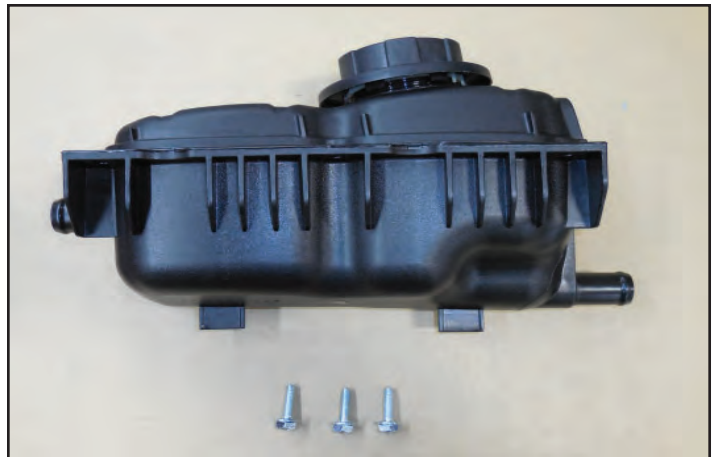

240. Gather the provided hose and spring clamps shown. Install the hose and spring clamps on the front of the reservoir as shown and connect to the upper CAC manifold hose barb.



241. Apply blue Loctite 242 to the 3 coolant reservoir bolts. Install the 3 reservoir bolts at the arrow locations and torque to 40 in-lbs.

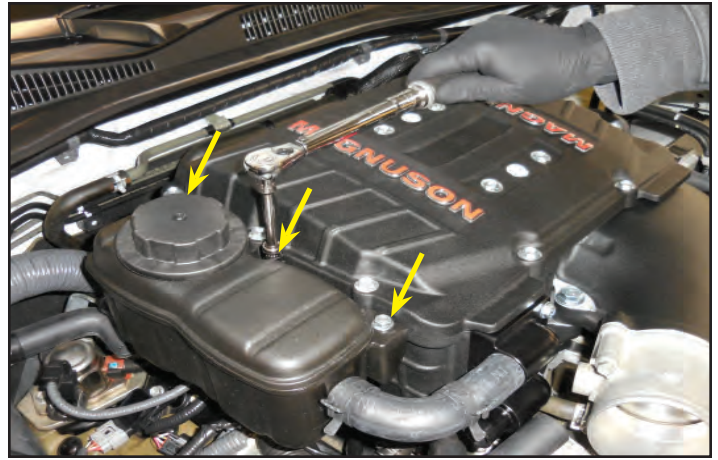

242. Install the hose from the upper LTR hose barb to the lower CAC manifold and secure with a provided spring clamp.



243. Rotate the swivel connector near the airbox to line up with the LTR to CAC hose.



244. Install the cable tie through the swivel clamp from the last photo and around the LTR to CAC hose. Do not pinch the hose.



245. Attach the hose coming from the intercooler pump input to the back of the reservoir and secure with a provided spring clamp.

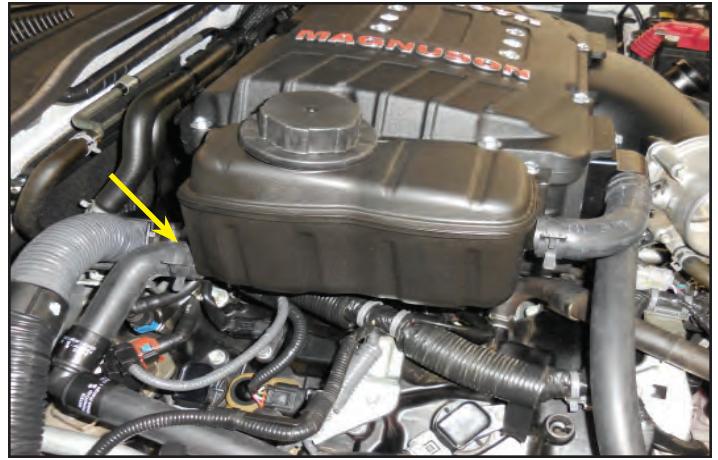

246. Gather the provided belt, tensioner and M8x60mm bolt.



247. Ensure that the pin on the tensioner shown with a yellow arrow in the photo to the right aligns with the hole on the idler bracket assembly that was installed earlier shown below with a red arrow.

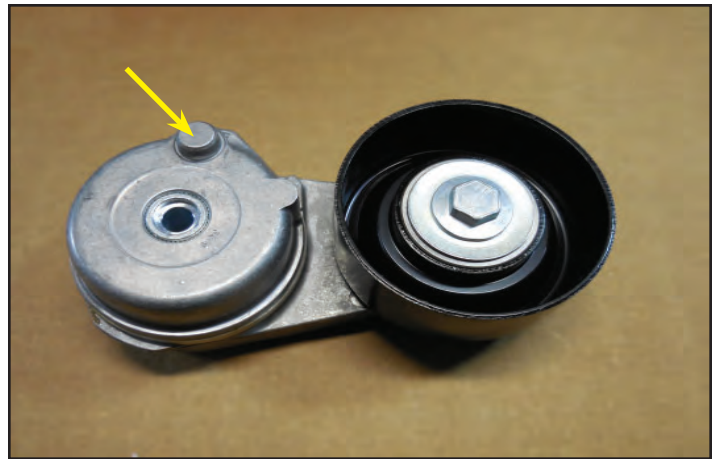
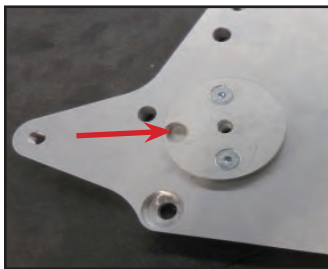

248. Install the belt with the smooth side riding on the idler pulley for the tensioner. This has to be pre installed before the tensioner is secured to the idler bracket that was installed earlier.



249. Align the pin on the tensioner with the hole in the plate that was installed earlier. **Torque the M8x60mm bolt to 18 ft-lbs** using a 12 mm socket wrench.

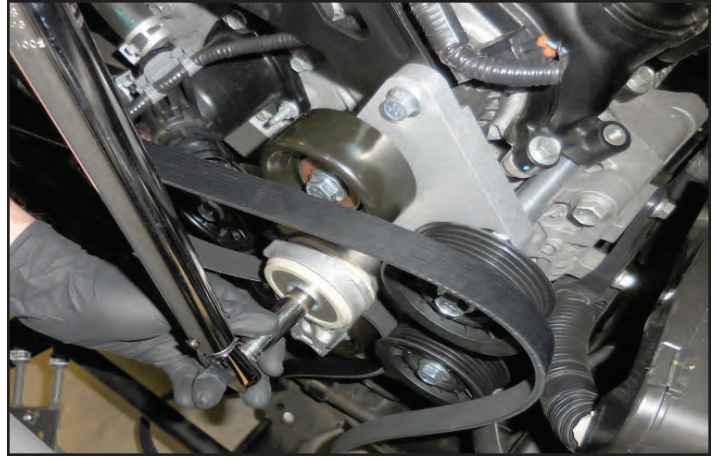

250. Route the belt according to the diagram at the back of this manual leaving the belt off the smooth idler pulley above the tensioner. Apply a clockwise torque on the tensioner shown at the arrow location using a 3/8" drive breaker bar or long arm ratchet and slip the belt over the last smooth idler pulley. **Note: Make sure belt is properly centered on pulleys.**



Section 14: Radiator Hose and Inlet Installation

251. Gather the provided hose and OE spring clamps.



252. Apply a thin layer of provided Lubriplate lubricant to the inside of each end of the hose from the last step.



253. Install the hose from last step into the locations shown with the red arrows with the long straight section on the radiator. Rotate the hose end at the engine so that the hose has the most clearance away from the belt lines and pulleys and secure with the provided spring clamps.

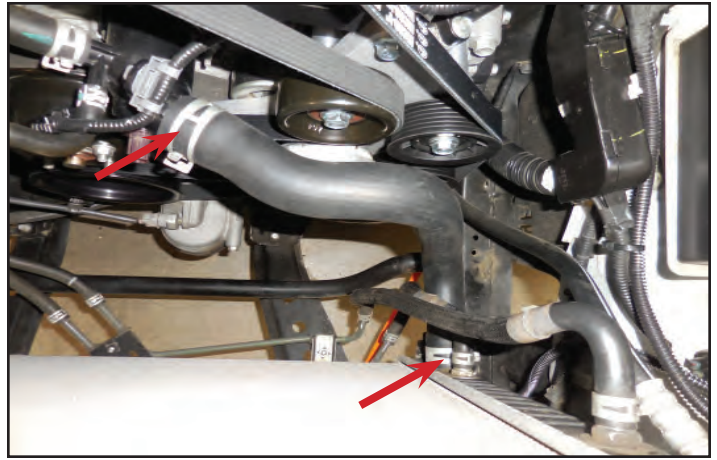

254. Remove the one nut that was left on the fan mount location.



255. Reinstall the fan and shroud back behind the radiator. **Torque the 4 nuts holding the fan using a 12 mm socket wrench to 15 ft-lbs.**



256. Align the bottoms of the fan shroud with the tabs on each side of the radiator.



257. Secure the fan shroud with the OEM bolts using a 10 mm socket wrench. **Torque these bolts to 50 in-lbs.**



258. Reattach the overflow hose.



259. Gather the provided IAT breakout harness (highlighted in green) and connect it between the OEM MAF connection and the MAF sensor at the air box (yellow arrow locations). Secure the excess wiring at the red arrow location with a provided cable tie to the airbox. Note: The air tube is shown installed for clarity. It will be installed later.



260. Connect the end of the IAT breakout wire to the IAT sensor (yellow arrow location). Secure the wiring at the red arrow location with a provided cable tie.

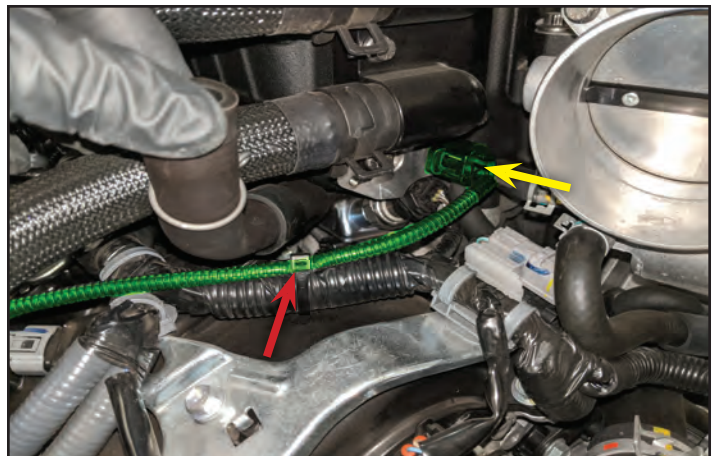

261. Gather the provided fresh air tube with the provided hose clamps. Ensure that the clamps are orientated as shown. Ensure that there is a clean air filter in the airbox as shown below, and close the lid. Some vehicles may have a paper filter which is ok.



262. Locate the provided fresh air tube in the location shown with the two arrows. You may need to rotate the air duct slightly to align the fresh air barb with the vacuum hose.



263. Attach the vacuum hose shown at the arrow location and secure with the OEM spring clamp. Rotate the air duct if necessary to align the vacuum hose and barb.



264. Trim a 2"x.5" section out of the passenger side radiator apron shown.

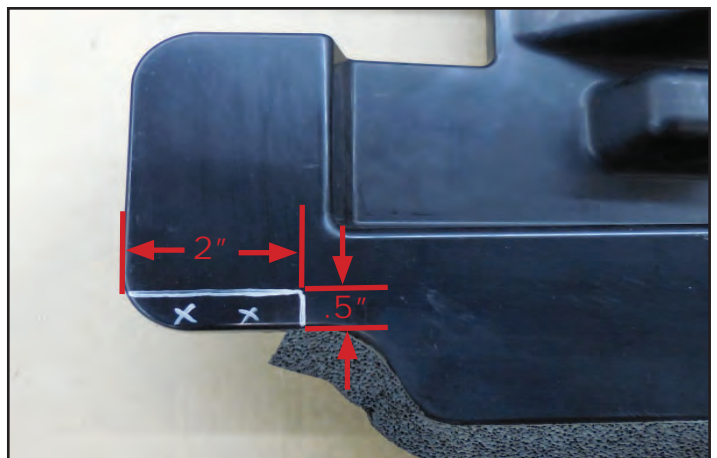

265. Ensure that the LTR to CAC hose has enough clearance once you have made the cuts from the last step.



266. Reinstall both of the radiator aprons and secure with OE push pins.

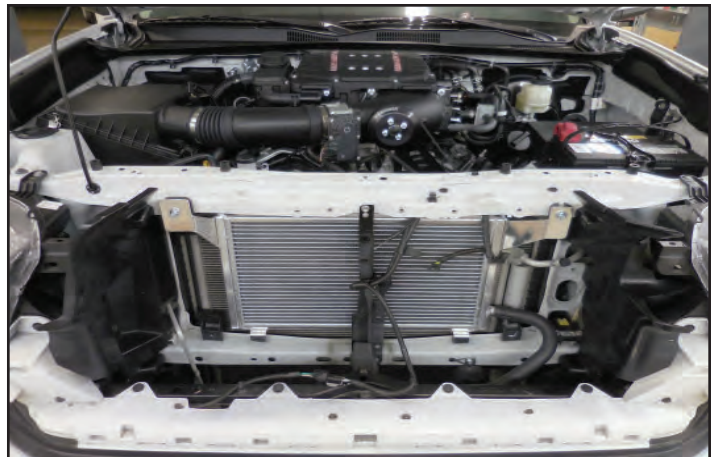

267. Reinstall the hood latch and all the electrical connection following the earlier steps in reverse. **Three hood latch bolts should be torqued to 108 in-lbs. Two horn bolts should be torqued to 12 ft-lbs. Vehicles with the trans cooler will get those three bolts torqued to 70 in-lbs. Do not forget to reinstall hood release cable!**



268. Reinstall the horns using the original bolts. Connect the electrical connectors and manage the wires to retain where needed.



Section 15: Oil and Coolant Fill and Final Testing

269. Ensure that the oil filter and oil drain plugs are installed and torqued before adding oil. Check the oil level and top off with the manufacturer's required viscosity and type.



270. Ensure that the petcock is closed before adding fluid. Add the manufacturer's recommended mixture of coolant to the radiator. You will need to re-check the coolant level after the engine heat cycles and the thermostat opens.



271. Reconnect the negative terminal of the battery.



Make sure that you have followed the steps at the beginning of this manual to load the proper Super-charger calibration to your vehicle's ECM.

*****WARNING: You must perform a vacuum leak down test on your intercooler system prior to adding any coolant. This can be accomplished with the same equipment that is used for engine cooling systems.*****

272. Add the same coolant mixture as in the engine radiator to the intercooler reservoir. Set the ignition to the accessory position and allow the pump to cycle while you fill the system. **Do Not start the engine.** Ensure that the pump does not run dry while you are filling the system. The coolant level should be within 1/2" from the top surface on the front of the tank. This will allow for coolant expansion.



273. Start the vehicle for 5 seconds and shut it off. Check for fuel leaks and belt alignment. Check the intercooler reservoir level and radiator level. Now start your engine and let it run for a few minutes to let it get to operating conditions. Let the engine cool down, and check all your levels again.



274. If there are no leaks you can reinstall the grill following the instructions from earlier in reverse.



275. Test drive the vehicle for the first few miles under normal driving conditions. **Do not perform any wide open throttle runs.** Listen for any noises, vibrations, engine misfire or anything that does not seem normal. The supercharger does have a slight whining noise under boost conditions, which is normal. Check and top off the intercooler reservoir and radiator as needed.



276. After the initial test drive gradually work the vehicle to wide open throttle runs, listen for any engine detonation (pinging). If engine detonation is present let up on the throttle immediately. Most detonation causes are low octane gasoline still in the tank.

If you have questions about your vehicles performance, please check with your installation facility.

After you finish your installation and road test your vehicle, please fill out the warranty registration. This can be found on our website.



Appendix

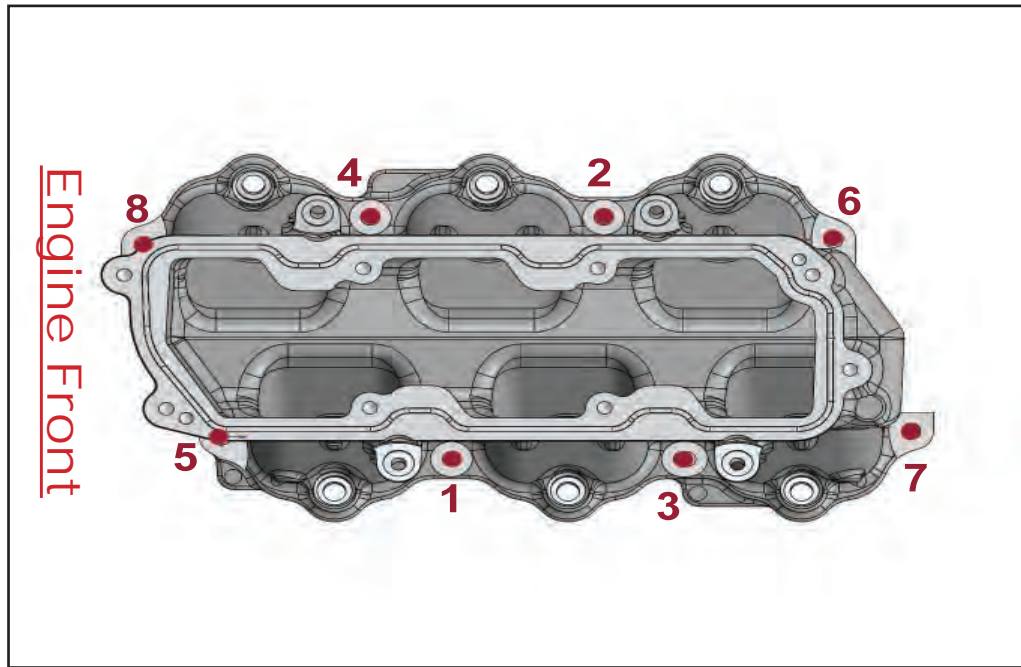

Torque Sequence for Lower Intake Manifold (18 ft-lbs)

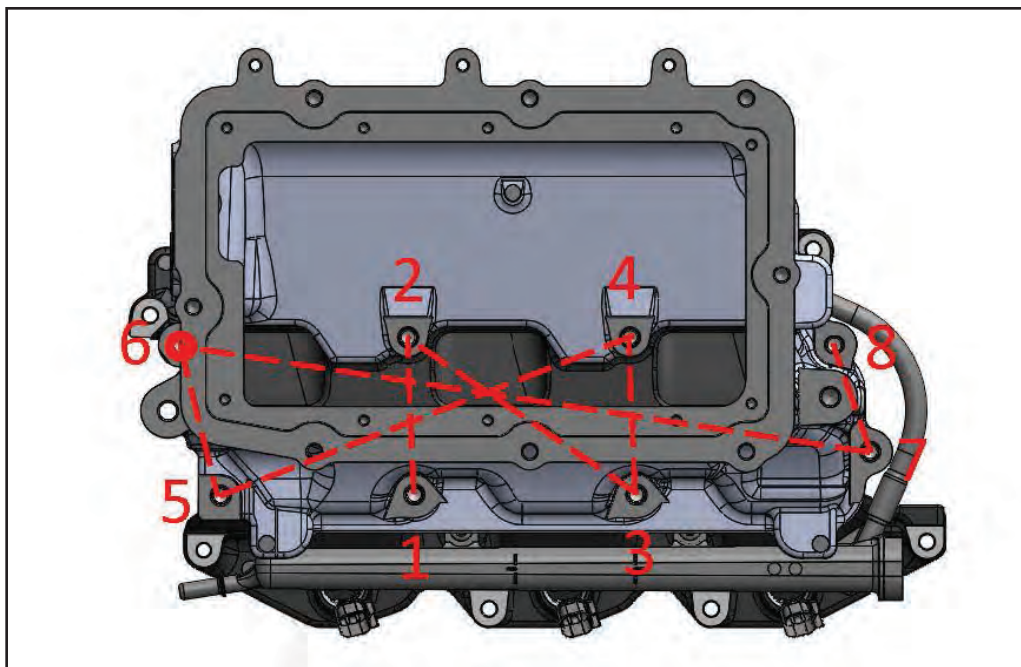

Torque Sequence for Upper Intake Manifold (18 ft-lbs)

Appendix

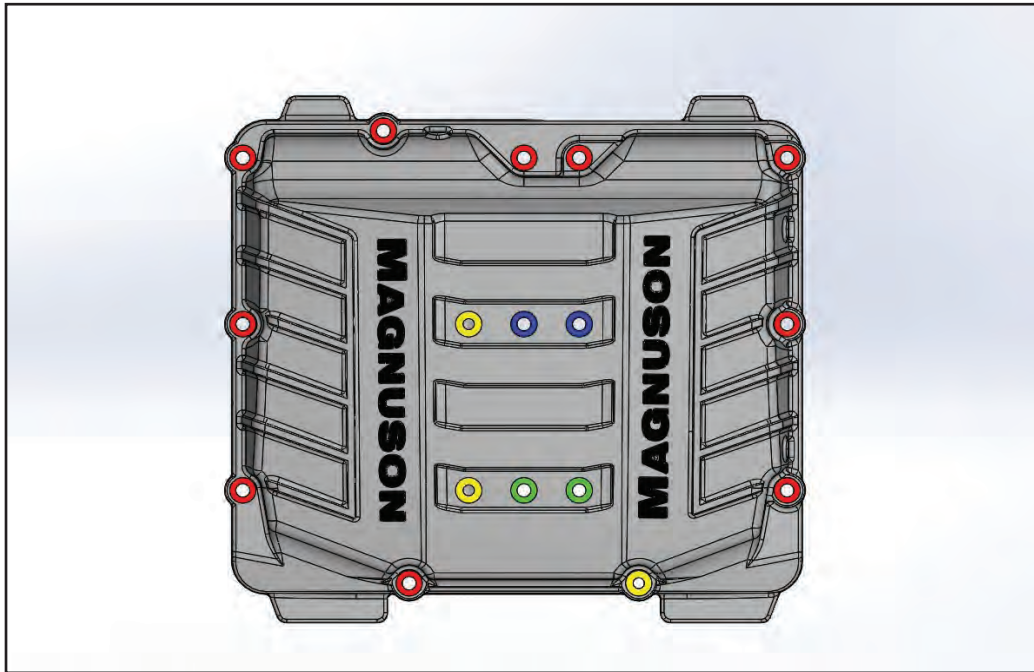

Lid fastener layout:

Three M8x16mm (FAUX-IN **YELLOW**)

Ten M8x30mm (PERIMETER-IN **RED**)

Two M8x45mm (FRONT CENTER-IN **GREEN**)

Two M8x65mm (REAR CENTER-IN **BLUE**)

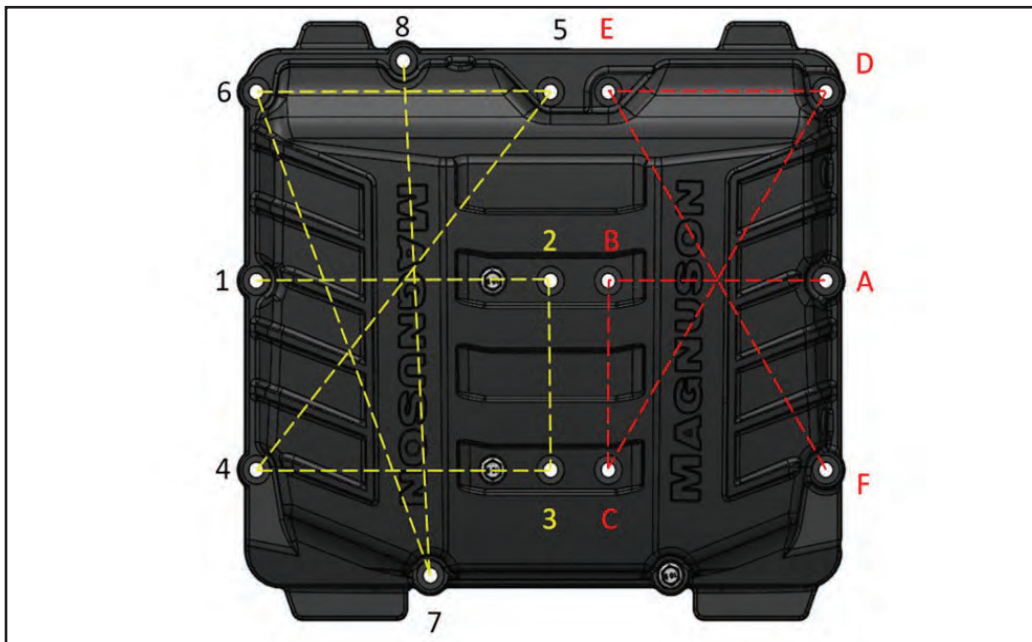

Torque Sequence for Lid (18 ft-lbs)

NOTES

NOTES

NOTES



Please enjoy your "Magnuson SuperCharged" performance responsibly.

Use only premium gasoline fuel, 91 octane or better.

MAGNUSON
SUPERCHARGERS