



GM LS SWAP

EFI; PASS. SIDE MOUNT

Supercharger Tuner Kit Installation Instructions

(For use with Corvette C5 FEAD)

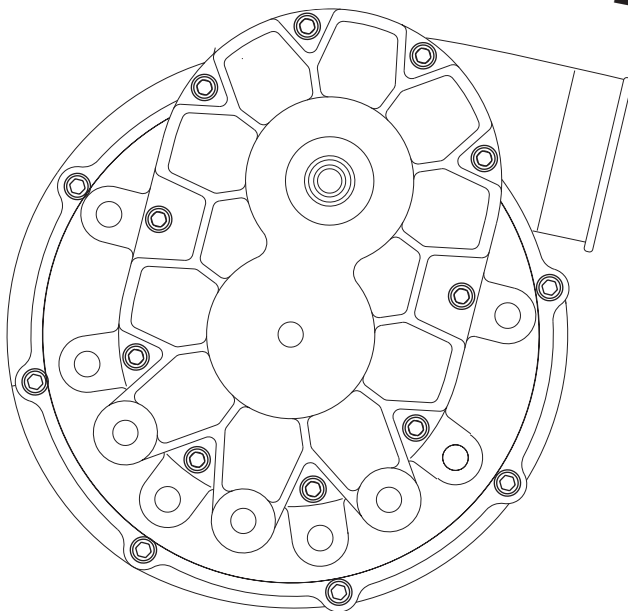

(Models legal in California only for racing vehicles which may never be used upon a highway.)



ENGINEERING, INC

1650 Pacific Avenue, Channel Islands CA 93033-9901 • Phone: 805 247-0226
Fax: 805 247-0669 • www.vortechsuperchargers.com • M-F 7:00AM - 3:30PM (PST)

FOREWORD

This manual provides information on the installation, maintenance and service of the Vortech supercharger kit expressly designed for this vehicle. All information, illustrations and specifications contained herein are based on the latest product information available at the time of this publication. Changes to the manual may be made at any time without notice. Contact Vortech Engineering for any additional information regarding this kit and any of these modifications at (805) 247-0226 7:00am-3:30pm PST.



Take note of the following before proceeding:

1. Proper installation of this supercharger kit requires general automotive mechanic knowledge and experience. Please browse through each step of this instruction manual prior to beginning the installation to determine if you should refer the job to a professional installer/technician. Please contact your dealer or Vortech Engineering for possible installers in your area.
2. This product was designed for use on stock (un-modified, OEM) vehicles. The PCM (computer), engine, transmission, drive axle ratios and tire O.D. must be stock. If the vehicle or engine has been modified in any way, check with Vortech prior to installation and use of this product.
3. Use only premium grade fuel with a minimum of 91 octane (*R+M/2*).
4. Always listen for any sign of detonation (*knocking/pinging*) and discontinue hard use (*no boost*) until problem is resolved.
5. Vortech is not responsible for any clutch, transmission, drive-line or engine damage.

Exclusions from Vortech warranty coverage considerations include, but not limited to:

1. Neglect, abuse, lack of maintenance, abnormal operation or improper installation.
2. Continued operation with an impaired vehicle or sub-system.
3. The combined use of Vortech components with other modifications such as, but not limited to, exhaust headers, aftermarket camshafts, nitrous oxide, third party PCM programming or other such changes.

©2016 VORTECH ENGINEERING, INC.

All rights reserved. No part of this publication may be reproduced, transmitted, transcribed, or translated into another language in any form, by any means without written permission of Vortech Engineering, Inc.

TABLE OF CONTENTS

FOREWORD	<i>ii</i>
TABLE OF CONTENTS	<i>iii</i>
IMPORTANT INSTALLATION NOTES	<i>v</i>
TOOL & SUPPLY REQUIREMENTS	<i>vi</i>
PARTS LIST	<i>vii</i>
REFERENCE DIMENSIONS	<i>x</i>
1. HARMONIC BALANCER PREPARATION	1
2. CRANK PULLEY INSTALLATION	3
3. MOUNTING BRACKET & SUPERCHARGER INSTALLATION	5
4. A/C PUMP MOUNTING BRACKET INSTALLATION	7
5. DRIVE BELT & MANUAL TENSIONER INSTALLATION	9
6. DISCHARGE DUCT & BYPASS VALVE INSTALLATION	11
7. FINAL CHECK	13

NOTICE

This product is protected by state common law, copyright and/or patent. All legal rights therein are reserved. The design, layout, dimensions, geometry, and engineering features shown in this product are the exclusive property of Vortech Engineering, Inc. This product may not be copied or duplicated in whole or part, abstractly or fundamentally, intentionally or fortuitously, nor shall any design, dimension, or other information be incorporated into any product or apparatus without prior written consent of Vortech Engineering, Inc.

IMPORTANT INSTALLATION NOTES

This kit should only be installed by qualified mechanics. It is imperative that **the correct air/fuel mixture be maintained at all times. This kit is to be supplied to competent engine tuners for their completion by the addition of, and tuning of, appropriate fuel and ignition control components.**

This product is intended for use on healthy, well maintained engines. Installation on a worn-out or damaged engine is not recommended and may result in failure of the engine.

Vortech Engineering is not responsible for engine damage. Installation on new engines will not harm or adversely affect the break-in period so long as factory break-in procedures are followed.

1. This tuner system is based on the OEM C5 Corvette damper and accessory/FEAD configuration. Your installation may require custom modifications when matched with non-C5 Corvette FEAD and vehicle components.
2. Pulley diameter changes: Careful size selection is mandatory for proper engine and supercharger longevity. Contact the Vortech Tech Line for assistance with impeller speed calculations if necessary.

	6.00" Crank Pulley <i>P/N: 4MA018-041</i>	7.00" Crank Pulley <i>P/N: 4MA018-051</i>	7.80" Crank Pulley
3.60" S/C Pulley <i>P/N: 2A031-360</i>	Belt Length - 59.4" <i>P/N: 2A041-594</i>	Belt Length - 61.0" <i>P/N: Gates K100610</i> (NOT AVAIL. THRU VORTECH)	S/C DRIVE BELT WILL NOT CLEAR WATER PUMP
3.47" S/C Pulley <i>P/N: 2A031-347</i>	Belt Length - 59.4" <i>P/N: 2A041-594</i>	Belt Length - 61.0" <i>P/N: Gates K100610</i> (NOT AVAIL. THRU VORTECH)	
3.33" S/C Pulley <i>P/N: 2A031-333</i>	Belt Length - 59.4" P/N: 2A041-594	Belt Length - 60.7" <i>P/N: 2A041-607</i>	
3.12" S/C Pulley <i>P/N: 2A031-312</i>	Belt Length - 58.5" <i>P/N: Dayco 5100585</i> (NOT AVAIL. THRU VORTECH)	Belt Length - 60.7" <i>P/N: 2A041-607</i>	

NOTE: Supercharger Drive Pulley - If the supercharger drive pulley will not slide onto the shaft, DO NOT FORCE IT. Light heating of the supercharger drive pulley with a propane torch will aid in installation.

Supercharger Crank Pulley - If the supercharger crank pulley will not slide onto the spacer, DO NOT FORCE IT. Light heating of the supercharger crank pulley with a propane torch will aid in installation.

GM LS SWAP

EFI; PASS. SIDE MOUNT

Installation Instructions

Congratulations on selecting the best performing and best backed automotive supercharger available today... the VORTECH® supercharger!

Before beginning this installation, please read through this entire instruction booklet and the Street Supercharger System Owner's Manual which includes the Limited Warranty Program, the Warranty Registration form and return envelope.

Vortech supercharger systems are performance improving devices. In most cases, increases in torque of 30-35% and horsepower between 35-45% can be expected with the boost levels specified by Vortech Engineering. This product is intended for use on healthy, well maintained engines. Installation on a worn-out or damaged engine is not recommended and may result in failure of the engine as well as the supercharger. Vortech Engineering is not responsible for engine damage.

Installation on new vehicles will not harm or adversely affect the break-in period so long as factory break-in procedures are followed.

For best performance and continued durability, please take note of the following key points:

1. Use only premium grade fuel 91 octane or higher (R+M/2).
2. The engine must have stock compression ratio.
3. If the engine has been modified in any way, check with Vortech prior to using this product.
4. Always listen for any sign of detonation (pinging) and discontinue hard use (no boost) until problem is resolved.
5. Perform an oil and filter change upon completion of this installation and prior to test driving your vehicle. Thereafter, always use a high grade SF rated engine oil or a high quality synthetic, and change the oil and filter at least every 3,000 miles. Never attempt to extend the oil change interval beyond 3,000 miles, regardless of oil manufacturer's claims as potential damage to the supercharger may result.
6. Before beginning installation, replace all spark plugs that are older than 1-year or 15,000 miles with original heat range plugs as specified by the manufacturer and reset timing to factory specifications (follow the procedures indicated within the factory repair manual and/or as indicated on the factory underhood emissions tag). Do not use platinum spark plugs unless they are original equipment. Change spark plugs every 20,000 miles.

TOOL & SUPPLY REQUIREMENTS

- Factory repair manual
- 3/8" socket and drive set: SAE & metric
- 1/2" socket and drive set: SAE & metric
- Adjustable wrench
- Open end wrenches: 3/8", 7/16", 1/2", 9/16"

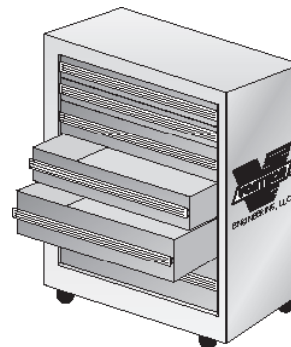

If it has been 15,000 miles or more since your vehicle's last spark plug change, then you will also need:

- Spark plug socket
- NEW spark plugs

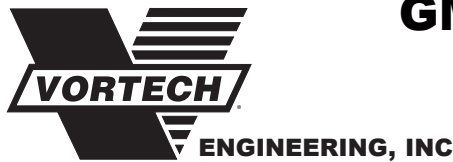

GM LS Swap, EFI; Pass. Side Mount

Part No. 4GX218-010L

PARTS LIST

IMPORTANT: Before beginning installation, verify that all parts are included in the kit. Report any shortages or damaged parts immediately.

PART NO.	DESCRIPTION	QTY.	PART NO.	DESCRIPTION	QTY.
2F328-090	V3 S/C ASY, LS SWAP, SAT	1	4GX218-030L KITS INCLUDE THE ASSEMBLY BELOW		
4GR110-110	ASSY, DAMPER PIN, LS1-LS2-LS6	1	4GX110-021	ASY, BRACKET, AC, LS SWAP	1
4GX020-010	INSTR MAN, LS SWAP KIT	1	2A017-016	PILOT, 6203/5 BRG, M10 3/8 SPC	1
4GX110-044	MNTG BRKT ASSY, LSX SWAP	1	2A046-935	BELT, 4060935-GOODYEAR	1
2A017-878-09	SPACER, .875 OD X 2.42 LONG	7	4FQ017-061	IDLER SPACER, .875 OD X .503 L	1
4GX010-044	MNTG PLT, FRONT, S/C	1	4GX010-021	BRACKET, FRONT, AC, LSX SWAP	1
4GX010-010	MNTG PLT, REAR, CYL HEAD	1	4GX010-031	BRACKET, REAR, AC, LSX SWAP	1
7A375-126	3/8-16 X 1.25 HHCS, GR8, PLT	5	4TX016-150	IDLER, 2.75" DIA, SMOOTH, 7 RIB	1
7A375-352	3/8-16 X 3.5" HX HD GR8	6	7A375-178	3/8-16 X 1-3/4 HXHD GR8	1
7C010-030	M10 X 1.5 X 30 HXHD CL10.9	3	7A375-375	3/8-16 X 3-3/4 HXHD	3
7C010-100	M10 X 1.5 X 100 HXHD CL8.8	1	7C010-020	M10 X 1.5 X 20 HXHD CL8.8	2
7J010-002	10MM WASHER, ZINC PLATED	4	7C010-035	M10 X 1.5 X 35 HXCS CL10.9 PLT	1
7K375-040	3/8 AN960 FLAT WASHER PLATED	11	7C080-025	M8 X 1.25 X 25 HXHD	2
7P375-075	3/4" HOSE BARB UNION, BRASS	1	7GL10-151	LOCK NUT, FLANGE, M10 X 1.5 ZN	1
7R002-010	#10 SAE TYPE F SS HOSE	3	7J010-002	WASHER, M10 FLAT, ZN PLT	3
7U030-065	HOSE, 3/4 X 90° RUBBER, SHORT	1	7K312-001	5/16 AN WASHER, PLATED	2
4GX116-010	DRIVE ASSY, 10-RIB, LSX SWAP	1			
2A017-012	SPACER, IDLR PULY, 5.0 10RIB	1			
2A041-594	BELT, K100594-GATES	1			
4FA016-171	DUST COVER (IDLER PULLEY)	1			
4FA111-062	S/C BELT TNSNR ASSY, 10-RIB	1			
4GX016-150	IDLER, GROOVED, 10-RIB, DUAL BRG	1			
4GX017-011	SPACER, CRANK PULLEY, LSX SWAP	1			
4MA018-041	CRANK PULLEY, 6", UNIVERSAL	1			
7B375-300	3/8-24 X 3" HXHD GR8	3			
7C012-065	M12 X 1.75 X 65MM HXHD	1			
7K375-040	3/8 AN960 FLAT WASHER PLATED	3			
4GX212-010	DISCH ASY, STD EFI, LSX SWAP	1			
4GX112-010	DISCHARGE TUBE, NON-COOLED, LSX	1			
7P375-250	3/8 X 3/8 X 1/4 MALE BARB TEE	1			
7PS300-275	REDUCER, BLK, 3.0-2.75	1			
7PS388-301	SLEEVE, 3.88"-3.0" X 90°	1			
7R002-044	#44 SAE TYPE F SS HOSE CLAMP	1			
7R002-048	#48 SAE TYPE F SS HOSE CLAMP	2			
7R002-064	#64 SAE TYPE F SS HOSE CLAMP	1			
7U030-218	7/32 VACUUM HOSE, BUNA-N	5FT			
8D204-064	RACE BYPASS VALVE, G3, BLK/SAT	1			
8H040-175	FILTER, 1.75" I.D., RACE BYPASS	1			
8H040-400	AIR FILTER, 4" FLANGE, 12" LONG	1			

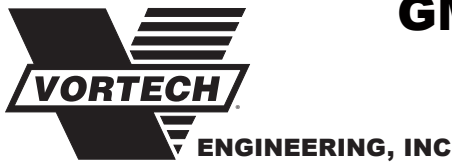

GM LS Swap, EFI; Pass. Side Mount

Part No. 4GX218-010L

PARTS LIST

IMPORTANT: Before beginning installation, verify that all parts are included in the kit. Report any shortages or damaged parts immediately.

NOTE: For optimal operation of this supercharger system, Vortech recommends using the following accessories. (NOT available through Vortech)

ARP Balancer Bolt Kit
P/N: 234-2503
QTY: 1



Note: Any straight water neck is OK.
Mr. Gasket Chrome Water Neck
P/N: 2671
QTY: 1



Summit Racing Harmonic Damper
P/N: SUM-C2501
QTY: 1



Chevrolet Perf. Deluxe Serpentine Drive Kit
P/N: 19257325
QTY: 1



ACDelco Mechanical Water Pump
P/N: 19195105
QTY: 1



For kits w/optional A/C Pump Mounting Kit
Sanden A/C Pump
P/N: SD7B10 / 7176
QTY: 1



GM LS Swap, EFI; Pass. Side Mount

Part No. 4GX218-010L

PARTS LAYOUT

IMPORTANT: Before beginning installation, verify that all parts are included in the kit. Report any shortages or damaged parts immediately.

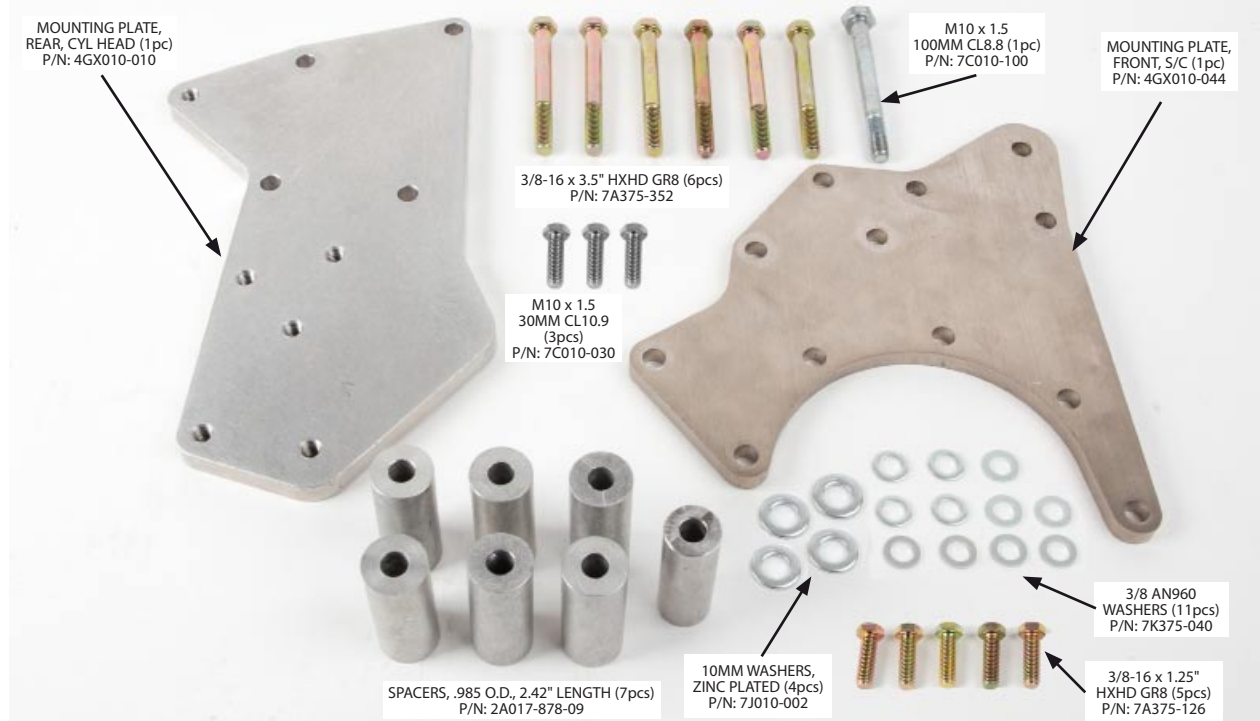

4GX110-044 | MOUNTING BRACKET ASSEMBLY, LSX SWAP



4GX110-021 | ASY, BRACKET, AC, LSX SWAP (OPTIONAL)



ENGINEERING, INC

GM LS Swap, EFI; Pass. Side Mount

Part No. 4GX218-010L

PARTS LAYOUT, cont'd

IMPORTANT: Before beginning installation, verify that all parts are included in the kit. Report any shortages or damaged parts immediately.



4GX116-010 | DRIVE ASSEMBLY, 10-RIB, LSX SWAP

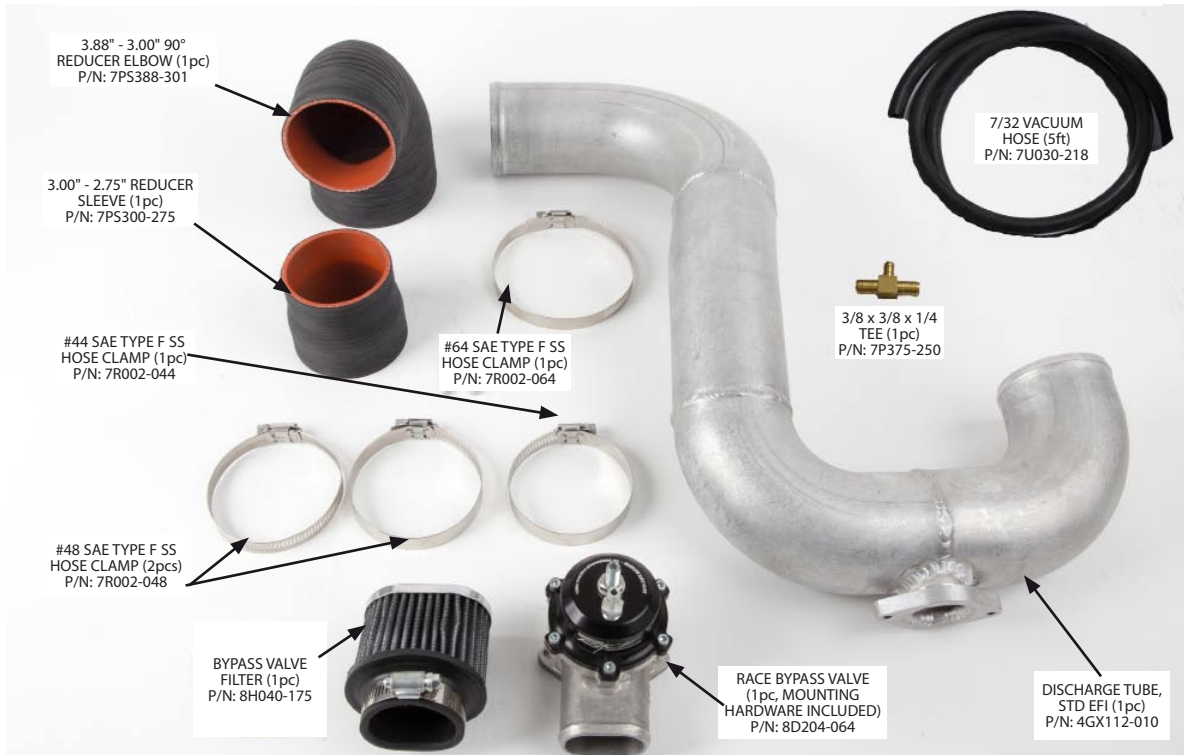

4GX212-010 | DISCHARGE ASSEMBLY, NON-COOLED, LSX SWAP

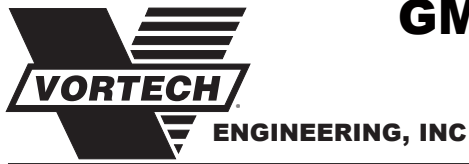

GM LS Swap, EFI; Pass. Side Mount

Part No. 4GX218-010L

PARTS LAYOUT, cont'd

IMPORTANT: Before beginning installation, verify that all parts are included in the kit. Report any shortages or damaged parts immediately.

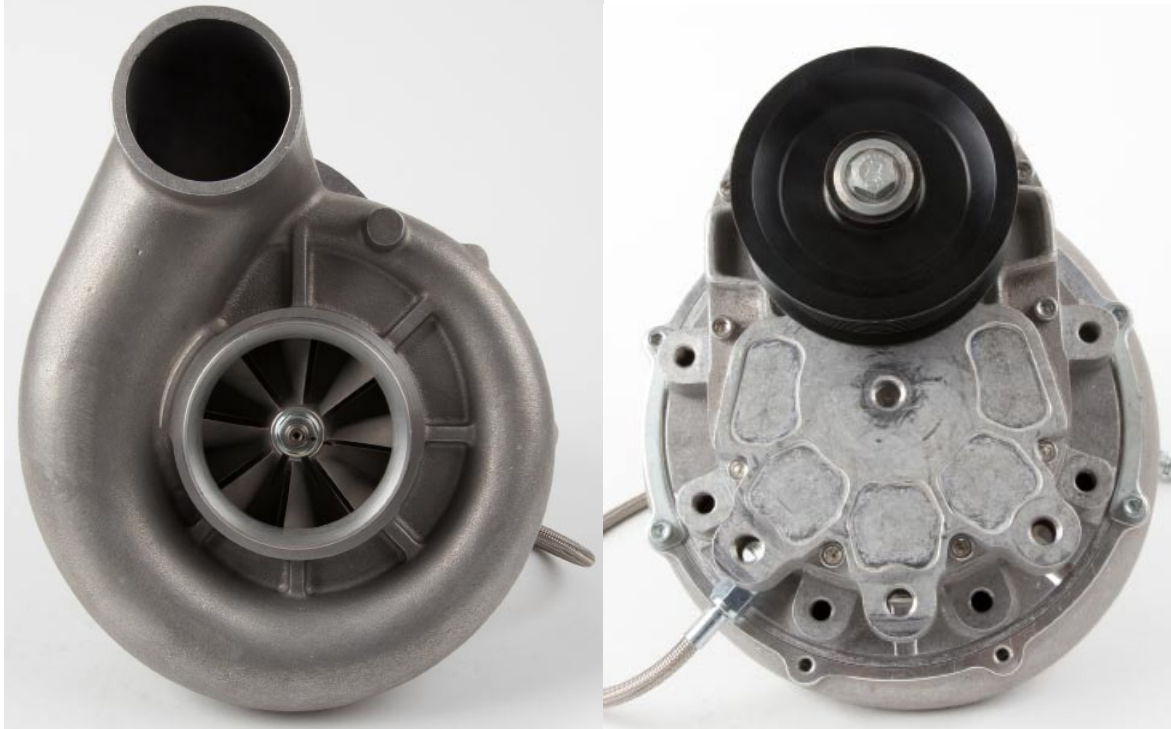

2F328-090 | V3 S/C ASY, LSX SWAP, SAT

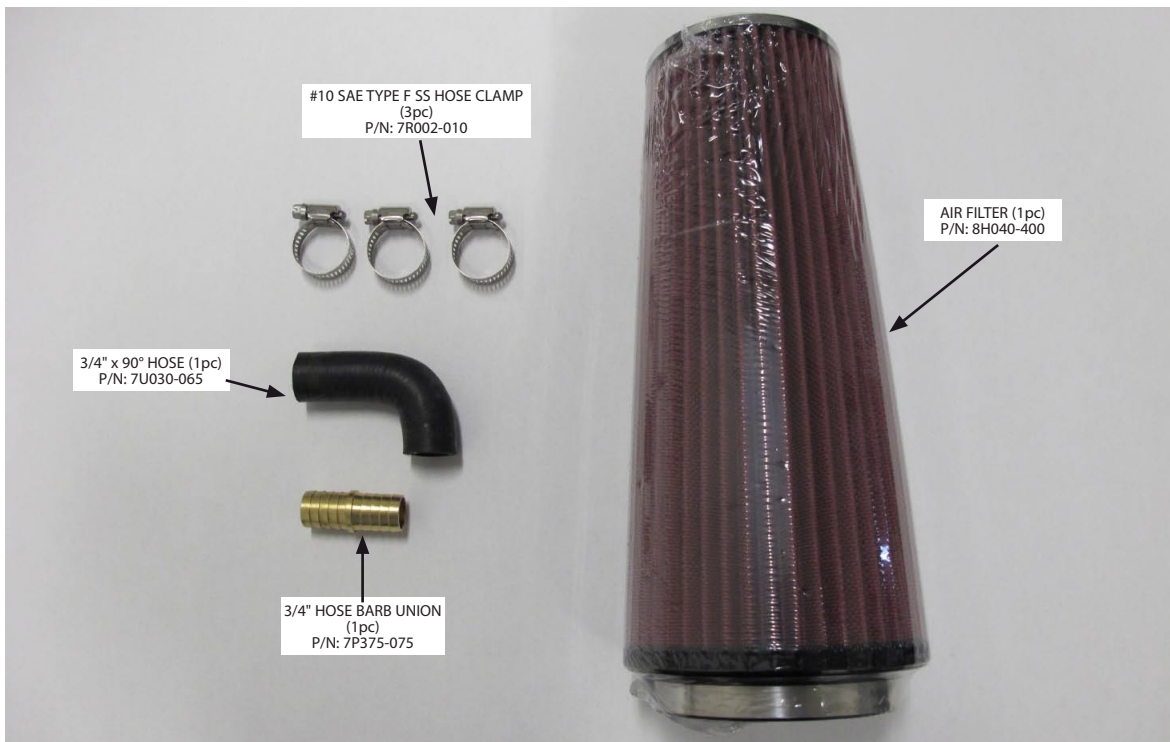

MISC. COMPONENTS



ENGINEERING, INC

GM LS Swap, EFI; Pass. Side Mount

Part No. 4GX218-010L

Reference Dimensions

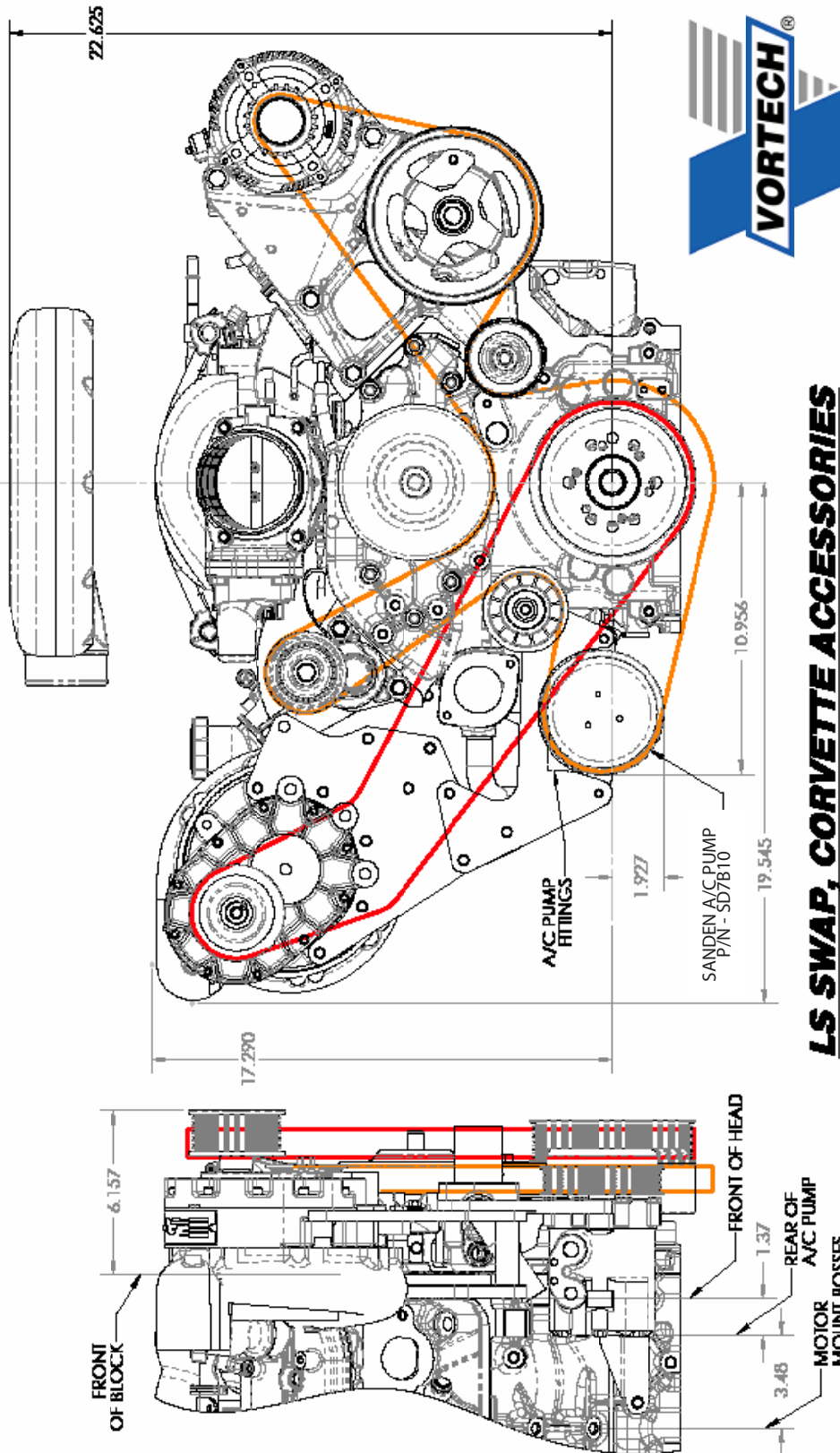

LS SWAP, CORVETTE ACCESSORIES

1. HARMONIC BALANCER PREPARATION

NOTE: This supercharger system is designed to be used with the Chevrolet Corvette C5 FEAD. Use of a different FEAD may result in improper system operation.

NOTE: For manual cars, be sure to place car in neutral.

- A. Remove the 4-rib A/C "stretchy" belt as follows: Using a 15/16" or 24mm socket and wrench, rotate the harmonic damper clockwise while pushing the top of the belt toward the rear of the vehicle. (See Fig. 1-a)
- B. Lock the engine from rotating and remove the OEM damper pulley bolt. Using a proper damper removal tool, remove the crank pulley. (See Fig. 1-b)

NOTE: Automatic transmission cars can lock the engine through the trans dust cover with an open end wrench to one of the torque converter mounting bosses on the flex plate.

Manual transmission cars place car in 5th / 6th gear with wheels on the ground and apply parking brake.

- C. Install the replacement damper onto the crankshaft using a proper damper installation tool with thrust bearing. (See Fig. 1-c)

NOTE: Do NOT use the NEW supplied crank bolt to "pull" the damper onto the crankshaft.



Fig 1-a

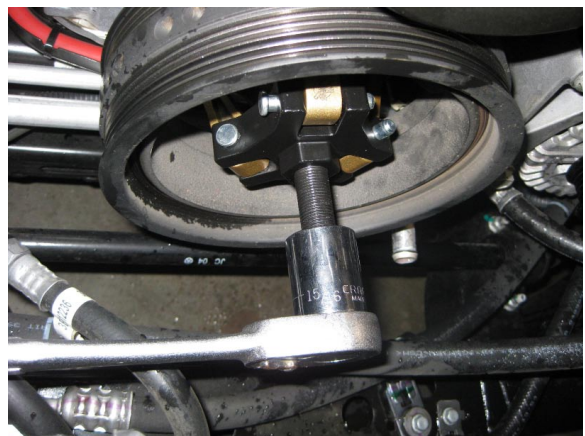

Fig 1-b



Fig 1-c

1. HARMONIC BALANCER PREPARATION (cont'd)

- D. After the new damper is fully seated, remove install tool. Install the supplied drill guide with the raised section piloting in the damper bore. Temporarily secure in place by installing the supplied socket head cap screw. Do not over-tighten the screw as it may distort the drill guide (its purpose is just to hold the guide in place while drilling). (See Fig. 1-d)
- E. Using an angle or small drill motor, mark supplied $\text{\O}1/4"$ drill bit with electrical tape or use a drill stop to ensure that the hole will be deep enough for the supplied $1/2"$ long dowel pins. (The depth of the drilled hole will reach $1/2"$ when the 2.27" mark on the drill bit is flush with the face of the damper.) (See Fig. 1-e)
- F. Drill the hole making sure to keep the tool perpendicular to the damper. Use extra care. Drill only as deep as necessary.
- G. Remove the socket head cap screw and drill guide. Install the supplied $\text{\O}1/4" \times 1/2"$ long dowel pin into the drilled hole with the chamfered end pointed toward the front of the vehicle. (See Fig. 1-g)
- H. Verify that the dowel pin is recessed slightly from the damper face. Install the supplied new damper retaining bolt as follows:
- Lightly coat the threads of the new retaining bolt with red threadlocker. Install and torque to 37 Ft-lb.
 - Using a $1/2"$ or larger breaker bar, tighten the retaining bolt an additional 120° or tighten with a torque wrench to 250 ft-lbs.(See Fig. 1-h)



Fig 1-d



Fig 1-e



Fig 1-h

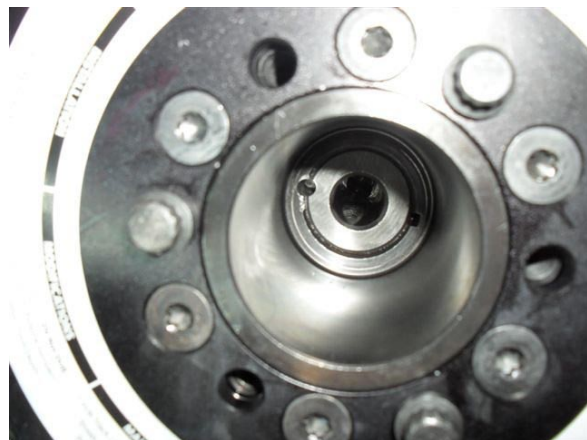

Fig 1-g

2. CRANK PULLEY INSTALLATION

NOTE: Use blue thread locker on all screws & torque in a criss-cross sequence.

- A. Locate the provided crank pulley & spacer. Align the 3 mounting holes on the crank pulley spacer with the corresponding holes on the crank pulley. Insert the (3) 3/8-24 x 3.00" and (3) 3/8 washers through the mounting holes. (See Fig. 2-a)

NOTE: If the supercharger crank pulley will not slide onto the spacer DO NOT FORCE IT. Light heating of the supercharger crank pulley with a propane torch will aid in installation.

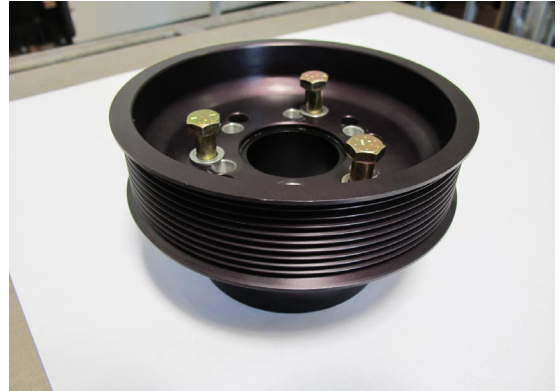

Fig 2-a

- B. Make sure the mounting surface where the crank pulley spacer will be installed is clean and clear of any debris. (See Fig. 2-b)



Fig 2-b

- C. Line up the 3 mounting screws with the 3 mounting holes on the damper & thread them by hand. Once fully seated, torque to 37 ft/lbs. (See Fig. 2-c)

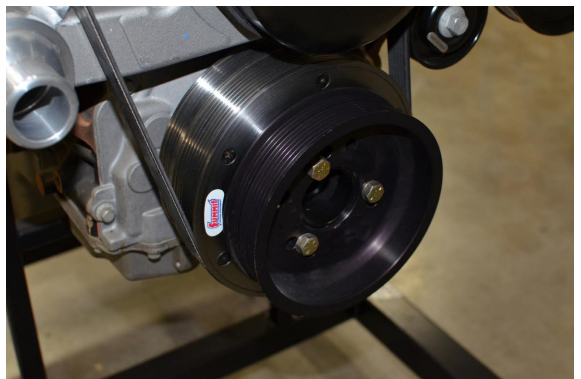

Fig 2-c

This page was left intentionally blank.

3. MOUNTING BRACKET & SUPERCHARGER INSTALLATION

- A. Make sure there is nothing currently installed on the passenger side cylinder head. The holes that will be used by the cylinder head bracket are marked in Figure. 3-a.

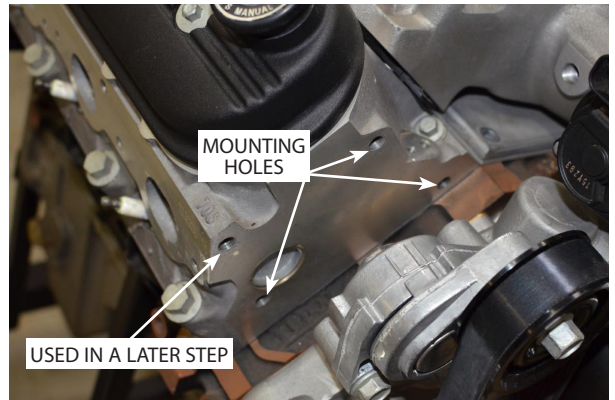

Fig 3-a

- B. Locate the (3) M10 x 30mm screws & (3) 10mm washers & install them into the cylinder head bracket. Proceed to line up the screws with the cylinder head mount holes & begin to thread them in. Leave them hand tight at this time. (See Fig. 3-b)

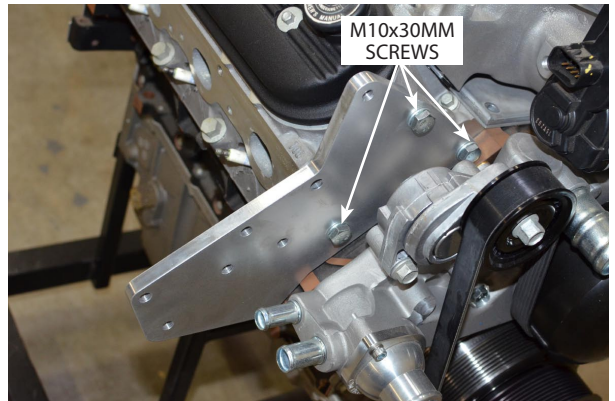

Fig 3-b

- C. Locate the provided M10 x 100mm screw, remaining 10mm washer & (1) 2.42" long spacer. The M10 x 100mm screw will go through both brackets & into the cylinder head. Install the M10 x 100mm screw & washer into its corresponding hole on the supercharger bracket, then proceed to install it through the cylinder head bracket & into the remaining hole on the cylinder head. Use this as a temporary pivot. (See Fig. 3-c)

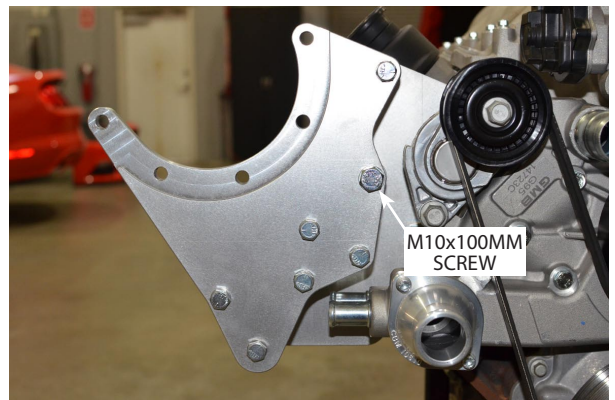

Fig 3-c

3. MOUNTING BRACKET & SUPERCHARGER INSTALLATION, cont'd

NOTE: If your kit includes the optional "A/C Pump Mounting Bracket Kit", leave the lowest (3) 3/8-16 X 3.50" mounting bracket screws loosely installed as longer screws are required for use with the A/C mounting bracket.

- D. Proceed to install the remaining (6) 2.42" long spacers & (6) 3/8-16 x 3.5" screws. Use 3/8 washers on all 3/8 screws. With all hardware & spacers correctly installed, proceed to tighten all of the mounting bracket hardware. (See Fig. 3-d)
- E. Install the supercharger unit onto the bracket & clock it as shown. Use the (5) remaining 3/8-16 x 1.25" screws & (5) 3/8 washers to secure the supercharger to the mounting bracket. You may tighten the hardware at this time. (See Fig. 3-e)
- F. Install the provided 3/4" x 90° heater hose elbow to the coolant port closest to the front of the engine. Trim the hose as shown, making sure that it is clear of the supercharger mounting bracket. Once in place, insert the provided 3/4" barbed hose union into the opposite end of the elbow. Secure both ends of the hose with the provided hose clamps. Vortech does not supply the remaining length of hose as LS engines are swapped into a variety of cars, but can be purchased at your local auto parts store. (See Fig. 3-f)
- G. The remaining coolant port will require 5/8" ID heater hose. You will be able to use a straight length of hose & route it through the supercharger mounting bracket. Vortech does not supply this length of hose as LS engines are swapped into a variety of cars, but can be purchased at your local auto parts store. (See Fig. 3-g)

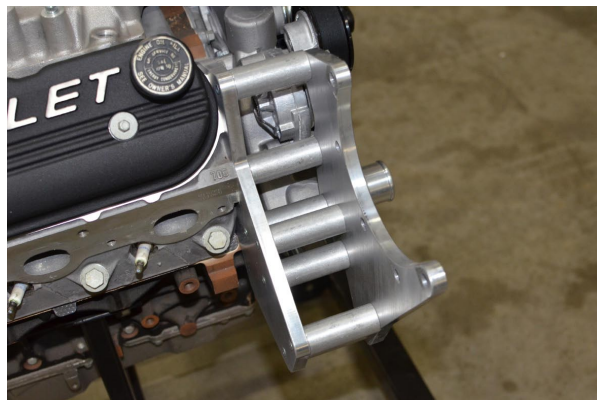

Fig 3-d

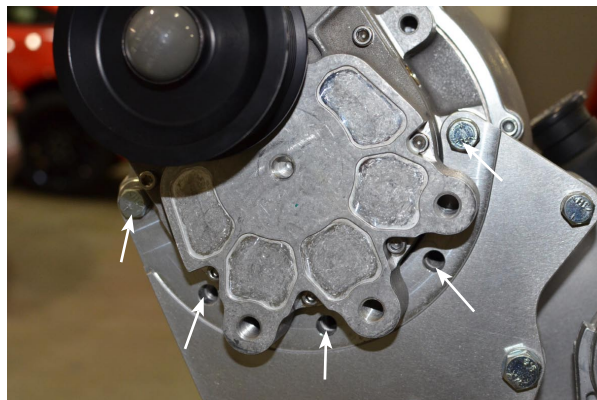

Fig 3-e



Fig 3-g



Fig 3-f

4. A/C PUMP MOUNTING BRACKET INSTALLATION

NOTE: This section is for kits with the optional "A/C Pump Mounting Bracket Kit". All others proceed to Section 5.

- A. Remove the factory-installed bushing from the rear of the A/C pump, opposite of the connection ports. (See Fig. 4-a)

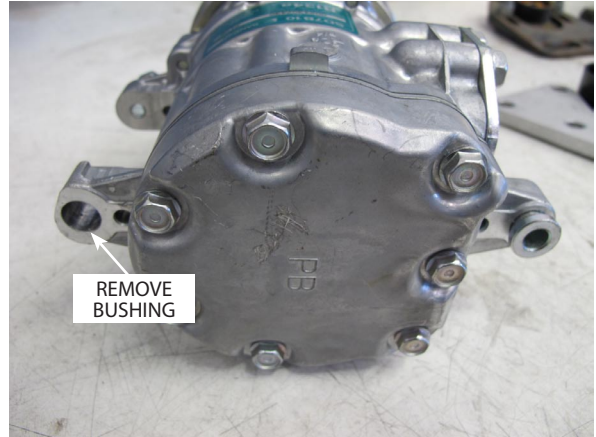

Fig 4-a

- B. Using the provided M10 X 20MM screws & M10 washers, loosely attach the rear A/C pump bracket to the threaded bosses above the oil pan, near the front passenger-side of the engine. (See Fig. 4-b)

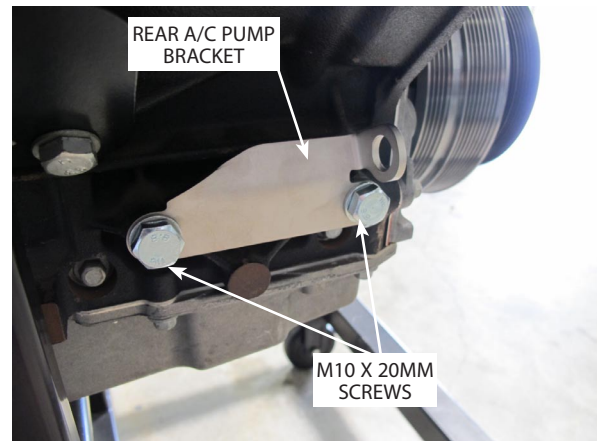

Fig 4-b

- C. Using the longer 3/8-16 X 3.75" screws & 3/8 AN washers, mount the bracket as shown. Only hand-tighten the screws at this time. (See Fig. 4-c)

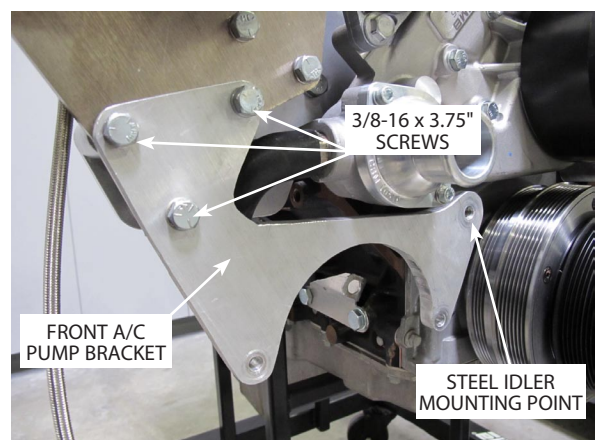

Fig 4-c

4. A/C PUMP MOUNTING BRACKET INSTALLATION, cont'd

- D. Install the provided 2.75" steel idler to the provided A/C bracket using the provided 3/8-16 X 1.75" screw, .503 idler spacer & bearing pilot. (See Fig. 4-e)

NOTE: Due to the variance in casting methods, the water pump housing may need to be modified slightly in order to provide proper clearance for the steel idler pulley.

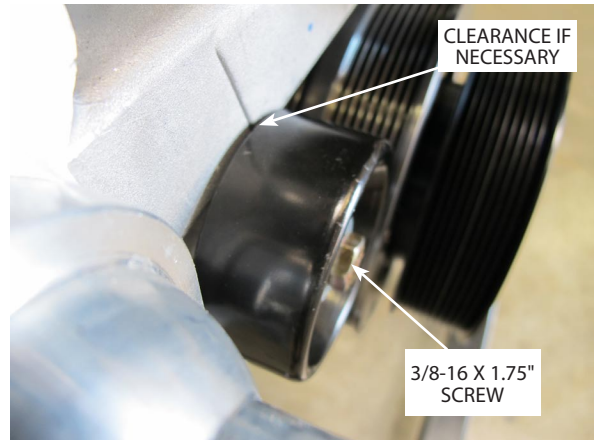

Fig 4-d

- E. Using an M10 X 35MM screw, M10 washer & M10 nylock nut on the rear A/C mounting point & an M8 X 25MM & 5/16 AN washer on the front A/C mounting point, loosely install the right side of the A/C pump to both A/C brackets as shown. (See Fig. 4-f)

- F. Swing the A/C pump upwards & secure it to the remaining mounting location using an M8 X 25MM screw & 5/16 AN washer. Once everything is lined up & secure, proceed to tighten all hardware. (See Fig. 4-g)

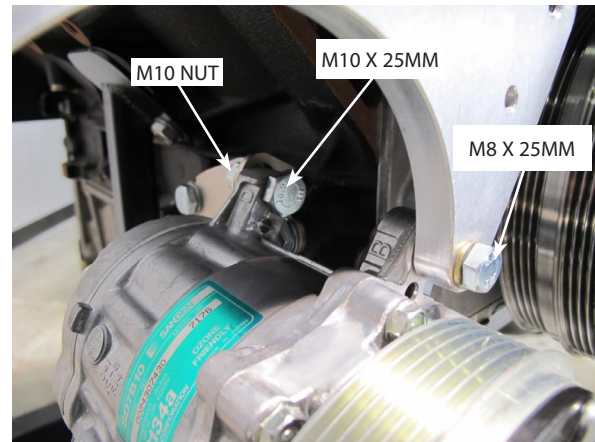

Fig 4-e

- G. Route the provided accessory drive belt as shown. Turn the spring tensioner clockwise to release tension, then slide the belt underneath the water pump pulley. Once in place, verify that the belt is correctly routed & tension the belt. (See Fig. 4-g)

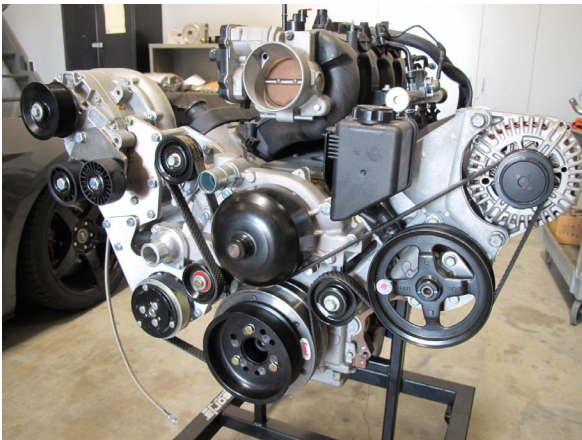

Fig 4-g

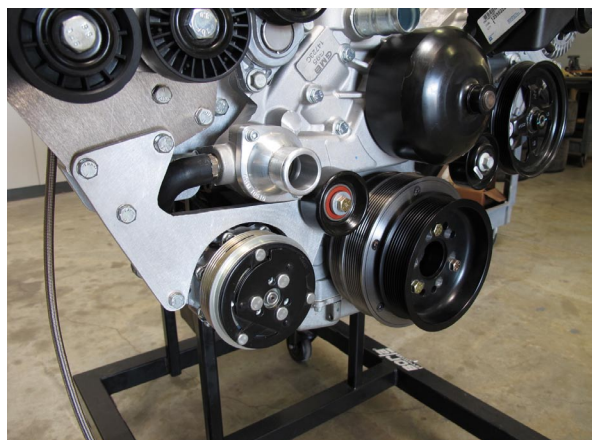

Fig 4-f

5. DRIVE BELT & MANUAL TENSIONER INSTALLATION

- A. Install the provided manual tensioner assembly to the supercharger gear case using (2) M12 x 1.75 x 20mm screws & (2) 12mm washers. Install the ribbed idler, spacer, dust cover & screw through the tensioner plate & into the boss on the supercharger. Leave the hardware loose at this time. (See Fig. 5-a)

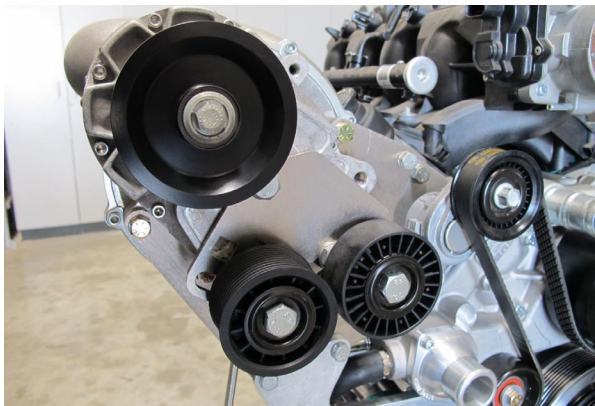

Fig 5-a

- B. Locate the provided supercharger belt & wrap it around the pulleys as shown. (See Fig. 5-b)



Fig 5-b

- C. Once routed, rotate the manual tensioner & use a 3/4" wrench to tighten the manual tensioner hardware. Be sure not to apply an excessive amount of tension to the drive belt. (See Fig. 5-c)

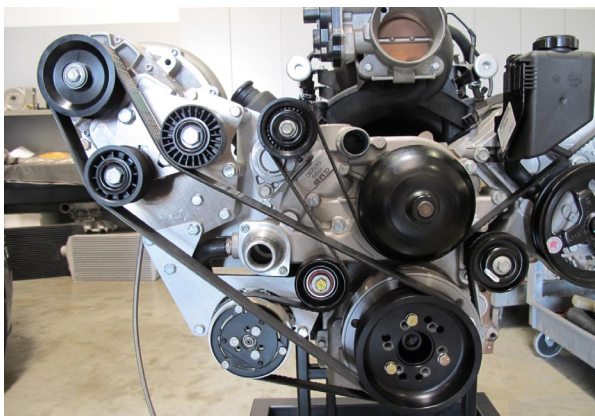

Fig 5-c

This page was left intentionally blank.

6. DISCHARGE DUCT & BYPASS VALVE INSTALLATION

- A. Install the 3.00"-2.75" reducer sleeve, (1) #44 hose clamp & (1) #48 hose clamp to the supercharger outlet. Leave the hose clamps loose at this time. (See Fig. 6-a)

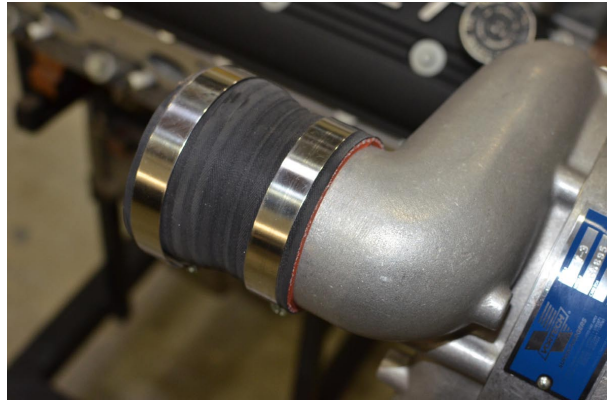

Fig 6-a

- B. Install the 3.88"-3.00" 90° reducer elbow to the throttle body. Use a #64 hose clamp on the throttle body end & a #48 hose clamp on the other. Leave the hose clamps loose at this time. (See Fig. 6-b)

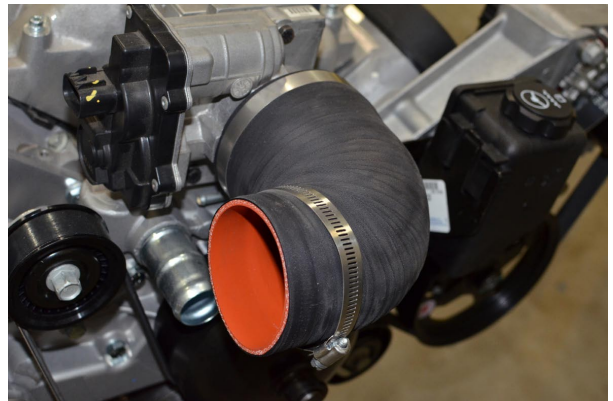

Fig 6-b

- C. Locate the discharge tube & slide the end closest to the bypass valve into the reducer sleeve on the supercharger outlet. (See Fig. 6-c)

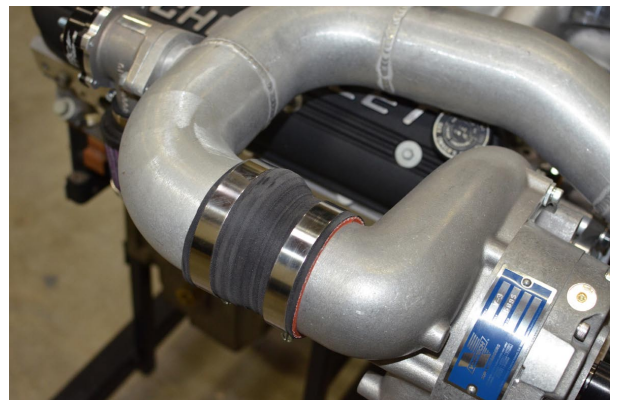

Fig 6-c

6. DISCHARGE DUCT & BYPASS VALVE INSTALLATION (cont'd)

- D. Insert the remaining end of the tube into the 90° elbow installed on the throttle body. Once in place, tighten all of the hose clamps. (See Fig. 6-d)

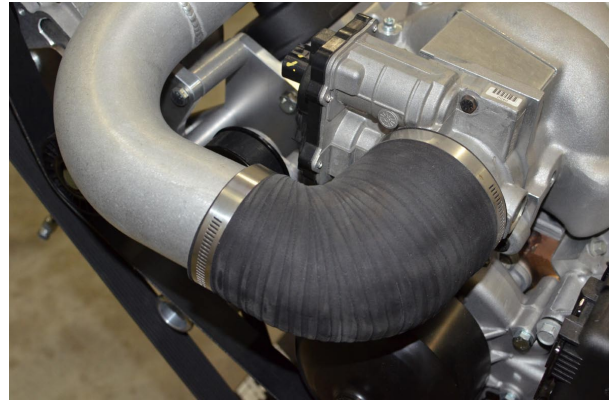

Fig 6-d

- E. Install the bypass valve filter to the bypass valve. Use the provided hardware that came with the bypass valve & install it as shown. Be sure to use the provided gasket in between the bypass valve & mounting flange on the discharge tube. (See Fig. 6-e)



Fig 6-e

- F. Included in this kit is a 5ft length of 7/32 vacuum hose. Attach one end of the hose to the fitting on the bypass valve. If possible, attach the other end of the vacuum hose directly to the intake manifold. If that is not an option, use the supplied 3/8 vacuum fitting & tee into a source that will see full vacuum and boost. Secure with the provided clamps. (See Fig. 6-f)

NOTE: On average, most brake booster lines are 3/8 I.D. Depending on your application, you may need to purchase a different vacuum fitting for proper fitment. Most fittings can be found at your local hardware store.



Fig 6-f

7. FINAL CHECK

WARNING: Do not attempt to operate the vehicle until all components are installed and all operations are completed including the final check.

- A. If your vehicle has gone over 15,000 miles since its last spark plug change, you will need to change the spark plugs now *before* test driving the vehicle.
- B. Check all fittings, nuts, bolts and clamps for tightness. Pay particular attention to oil and fuel lines around moving parts, sharp edges and exhaust system parts. Make sure all wires and lines are properly secured with clamps or tie-wraps.
- C. Check all fluid levels, making sure that your tank(s) is/are filled with 91 octane or higher fuel before commencing test drive.
- D. Start the engine and allow to idle a few minutes, then shut off.
- E. Recheck to be sure that no hoses, wires, etc. are near exhaust headers or moving parts. Look also for any signs of fluid leakage.
- F. **PLEASE TAKE SPECIAL NOTE:** Operating the vehicle without ALL the subassemblies completely and properly installed may cause **FAILURE OF MAJOR COMPONENTS.**
- G. Test drive the vehicle.
- H. Always listen carefully for engine detonation. Discontinue heavy throttle usage if detonation is heard.
- I. Read the **STREET SUPERCHARGER SYSTEM OWNER'S MANUAL AND RETURN THE WARRANTY REGISTRATION FORM** within thirty (30) days of purchasing your supercharger system to qualify.

For internally lubricated V3 units only

This supercharger has been factory pre-filled with special Vortech synthetic lubricant. Oil does not need to be added to a brand new unit; however a fluid level check should be performed.

Prior to operating the supercharger on the vehicle and after installation onto the vehicle:

Remove the factory installed flat-head brass shipping plug (not the dipstick) from the top of the supercharger case. Replace the sealed shipping plug with the supplied "vented" plug. Do not operate the supercharger without it. Check the supercharger fluid level.

Fluid level checking procedure:

1. Ensure that the .06" copper sealing washer is located on the dipstick base.
2. Thread the clean dipstick into the unit until it seats.
3. Once the dipstick has seated, remove the dipstick from the unit. Fluid should register in the crosshatched area on the dipstick.
4. **DO NOT OVERFILL!!!** Drain excess fluid from the unit if it is above the maximum level on the dipstick.

Check the fluid level using the dipstick at least every 2,500 miles.

Initial supercharger fluid change must be performed at 2,500 miles. The supercharger fluid must be changed at least every 7,500 miles.

Drain the fluid, refill the unit with 4 oz. of Vortech V3 lubricating fluid and then confirm proper oil level using the dipstick. **DO NOT OVERFILL!!!**

WARNING: Use of any other fluid other than the special Vortech lubricant will void the warranty and may cause component failure.



ENGINEERING, INC

1650 Pacific Avenue, Channel Islands CA 93033-9901 • Phone: 805 247-0226
Fax: 805 247-0669 • www.vortechsuperchargers.com • M-F 7:00AM - 3:30PM (PST)