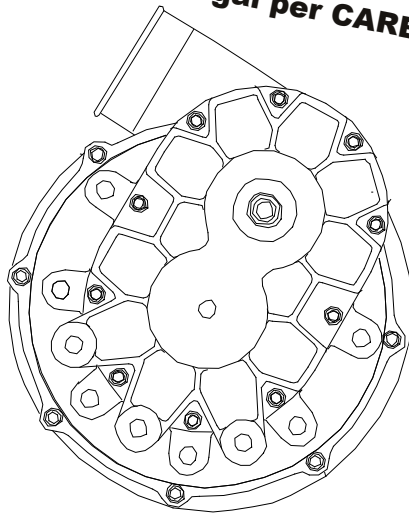


# Jeep Grand Cherokee 6.1L SRT-8 Supercharger System Installation Instructions

2005-2010 Model Years  
50 State Smog Legal per CARB EO# D-213-31



**ENGINEERING, INC**

1650 Pacific Avenue, Channel Islands CA 93033-9901 • Phone: 805 247-0226  
Fax: 805 247-0669 • [www.vortechsuperchargers.com](http://www.vortechsuperchargers.com) • M-F 8:00AM - 4:30PM (PST)

# FOREWORD

This manual provides information on the installation, maintenance and service of the Vortech supercharger kit expressly designed for this vehicle. All information, illustrations and specifications contained herein are based on the latest product information available at the time of this publication. Changes to the manual may be made at any time without notice. Contact Vortech Engineering for any additional information regarding this kit and any of these modifications at (805) 247-0226 8:00am-4:30pm PST.



## Take note of the following before proceeding:

1. Proper installation of this supercharger kit requires general automotive mechanic knowledge and experience. Please browse through each step of this instruction manual prior to beginning the installation to determine if you should refer the job to a professional installer/technician. Please contact your dealer or Vortech Engineering for possible installers in your area.
2. **This product was designed for use on stock (*un-modified, OEM*) vehicles.** The PCM (*computer*), engine, transmission, drive axle ratios and tire O.D. must be stock. If the vehicle or engine has been modified in any way, check with Vortech prior to installation and use of this product.
3. Use only premium grade fuel with a minimum of 91 octane (*R+M/2*).
4. Always listen for any sign of detonation (*knocking/pinging*) and discontinue hard use (*no boost*) until the problem is resolved.
5. Vortech is not responsible for any clutch, transmission, drive-line or engine damage.

## Exclusions from Vortech warranty coverage considerations include, but not limited to:

1. Neglect, abuse, lack of maintenance, abnormal operation or improper installation.
2. Continued operation with an impaired vehicle or sub-system.
3. The combined use of Vortech components with other modifications such as, but not limited to, exhaust headers, aftermarket camshafts, nitrous oxide, third party PCM programming or other such changes.

©2012 VORTECH ENGINEERING, INC

All rights reserved. No part of this publication may be reproduced, transmitted, transcribed, or translated into another language in any form, by any means without written permission of Vortech Engineering, Inc.

# TABLE OF CONTENTS

FOREWORD .....	ii
TABLE OF CONTENTS .....	iii
IMPORTANT NOTES .....	iv
UPDATE ECM .....	v
TOOL & SUPPLY REQUIREMENTS .....	v
PARTS LIST (4CK218-020L, Complete System) .....	vii
PARTS LIST (4CK218-120L, Tuner Kit) .....	ix
1. Preparation and Removal .....	1
2. Harmonic Damper Dowel Pin Installation .....	2
3. Fuel Injector Replacement .....	3
4. Supercharger Mounting Plate Installation .....	4
5. Supercharger Installation .....	6
6. Engine Coolant Hose Modification .....	7
7.A. Charge Air Cooler (CAC) Installation .....	8
7.B. CAC Reservoir and Water Pump Assembly and Installation .....	9
7.C. CAC Radiator Installation .....	12
8. Supercharger Discharge Assembly Installation .....	13
9. Fuel Pump Installation .....	14
10. Voltage Booster Installation .....	31
11. Reflash Computer .....	39
12. Final Assembly and Check .....	40

# **COPYRIGHT NOTICE**

This product is protected by state common law, copyright and/or patent. All legal rights therein are reserved. The design, layout, dimensions, geometry and engineering features shown in this product are the exclusive property of Vortech Engineering, LLC. This product may not be copied or duplicated in whole or part, abstractly or fundamentally, intentionally or fortuitously, nor shall any design, dimension, or other information be incorporated into any product or apparatus without prior written consent of Vortech Engineering, LLC.

# **TRACTION CONTROL NOTICE**

When driving the vehicle aggressively, excessive wheel spin may activate the vehicles' OEM traction control system. The traction control feedback may temporarily cause the vehicles' engine to operate erratically at heavy throttle inputs. This condition can be eliminated by temporarily defeating the vehicles' traction control (refer to the vehicle manufacturers' guidelines). Vortech does not recommend disabling the OEM traction control system. Use caution when operating the vehicle with a disabled traction control system, as loss of vehicle control may result.

# **SPARK PLUG NOTICE**

When driving the vehicle on "non-public roads", Vortech strongly recommends reducing the factory spark plug gap down to .032" (off-road applications such as racing / high RPM operation).

# **RADIATOR CAP NOTICE**

In supercharged and non-supercharged applications, Vortech has observed shortcomings in the OEM engine cooling radiator cap's ability to properly seal. Vortech recommends replacement of the OEM radiator cap with a quality aftermarket version, such as the Stant #11334, which is available at most local auto parts retailers for around \$5.00.

# ATTENTION

## BEFORE STARTING INSTALLATION, PLEASE NOTE THE FOLLOWING:

Your vehicle's ECM may need to be updated. This can be determined by locating the supplied Diablosport programmer and plugging it into the vehicle's OBD2 port.

Once the programmer is powered up and is at the main menu screen, there will be four options to choose from:

- Performance tune
- Diagnostics
- Options
- Tool information

Select performance tune and follow the screen for instructions.

If you are prompted to update the vehicle's calibration, disconnect the Diablosport programmer and follow these steps:

Tools required: Diablosport U7778 Interface Kit.

In the event you are unable to purchase or locate a U7778 Interface Kit, this process can be accomplished by using the vehicle for the power source (by plugging the programmer into the vehicle's OBD2 port) and by purchasing a USB to serial cable (RS232) (Note: if your computer has a serial cable outlet plug then just a serial cable will be needed).

If you are unable to use the vehicle as the power source, a power supply will be required.

The requirement for the power supply:  
Input 120 VAC 60Hz 30W output 12 VDC  
1000 Ma, with a 5.5 x 2.5 mm tip, positive center.

With the programmer powered up and connected, and the main menu screen being displayed:

- Type the following into your web browser: [vortechsuperchargers.com/dsinstaller](http://vortechsuperchargers.com/dsinstaller)
- Save the installer to your desktop. It should place an installer icon on your desktop.



DSDownloader

- Double-click on the DS Downloader installer on the desktop to start the installation process. Follow the prompts to install.
- Once the installer has completed, locate the new icon that the installer has placed on your desktop. (See Fig)
- With the programmer powered up and connected to your computer, double-click on the DSDownloader icon. You should see an option to download calibration update.
- Select the update and allow the program to connect to Diablosport's website. This may take a few minutes.
- Once the programmer has updated, disconnect it from the power source and the computer.
- Plug the programmer into the vehicle's OBD2 port and follow the main menu screen (as described in section 10).

---

Depending on the model year of the vehicle, new OEM radiator core support brackets may be required (P/N: 55394098AE). See step 7.C.1 for details.

# Jeep Grand Cherokee Installation Instructions

**Congratulations on selecting the best performing and best backed automotive supercharger available today... the VORTECH® Supercharger!**

**Before beginning this installation, please read through this entire instruction booklet and the Street Supercharger System Owner's Manual which includes the Automotive Limited Warranties Program and the Warranty Registration form.**

Vortech supercharger systems are performance improving devices. In most cases, increases in torque of 30-35% and horsepower of 35-45% can be expected with the boost levels specified by Vortech Engineering. This product is intended for use on healthy, well maintained engines. Installation on a worn-out or damaged engine is not recommended and may result in failure of the engine as well as the supercharger. **Vortech Engineering is not responsible for engine damage.**

Installation on new vehicles will not harm or adversely affect the break-in period so long as factory break-in procedures are followed.

**For best performance and continued durability, please take note of the following key points:**

1. Use only premium grade fuel 91 octane or higher (R+M/2).
2. The engine must have stock compression ratio.
3. If the engine has been modified in any way, check with Vortech prior to using this product.
4. Always listen for any sign of detonation (pinging) and discontinue hard use (no boost) until problem is resolved.
5. Before beginning installation, replace all spark plugs that are older than 1 year or 10,000 miles with original heat range plugs as specified by the manufacturer and reset timing to factory specifications (follow the procedures indicated within the factory repair manual and/or as indicated on the factory underhood emissions tag). **Do not use platinum spark plugs unless they are original equipment.** Change spark plugs every at least 15,000 miles and spark plug wires at least every 50,000 miles.

## **TOOL & SUPPLY REQUIREMENTS:**

- Factory Repair Manual
- 3/8" Socket and Drive Set: SAE & Metric
- 1/2" Socket and Drive Set: SAE & Metric
- Adjustable Wrench
- Open End Wrenches: 3/8", 7/16", 1/2", 9/16"
- Flat #2 Screwdriver
- Phillips #2 Screwdriver
- Drill Motor
- 1/8", 3/16", 1/4", 27/64" Drill Bits
- 3/16" Allen Wrench
- Wire Strippers and Crimpers
- Utility Knife

**If your vehicle has in excess of 15,000 miles since its last spark plug change, then you will also need:**

- Spark Plug Socket
- NEW Spark Plugs





# 2006-2010 Jeep Grand Cherokee

## Part No. 4CK218-020L/-028L

# PARTS LIST

**IMPORTANT:** Before beginning installation, verify that all parts are included in the kit. Report any shortages or damaged parts immediately.

PART NO.	DESCRIPTION	QTY	PART NO.	DESCRIPTION	QTY
008110	SMALL SILVER DIE CUT DECAL	2	4CK112-010*	AIR INLET ASSY, HEMI JGC	1
008130	LICENSE PLATE FRAME, VORTECH	1	*SEE PAGE VIII FOR ASSEMBLY COMPONENTS		
008341	POWERCOOLER DECAL	1	4CK112-020*	AIR DISCHARGE ASSY, HEMI JGC	1
008447	S/C STREET PACKAGE ASSEMBLY	1	*SEE PAGE VIII FOR ASSEMBLY COMPONENTS		
009035	S/C LUBE, BOTTLED, VORT 3-PACK	1	4CL110-110*	ASSY, DAMPER PIN HEMI	1
2A046-975	BELT K060975, JEEP HEMI	1	*SEE PAGE VIII FOR ASSEMBLY COMPONENTS		
2F329-190(8)	S/C ASSY, V3 CCW SI STR	1	8D204-010(06)	RACE BYPASS VALVE-BLACK	1
4GR033-032	PULLEY, SC, C5, 20MM, 32T	1	8N301-270(8)	WELDED CLR ASSY, HEMI JGC	1
7A312-125	5/16-18 X 1 1/4 GR5 HHCS, ZINC	2	4CK110-100	FUEL SYSTEM ASSY, JGC	1
4GS012-030(8)	DUCT, CAC TO TBODY, C6	1	4CK010-080	BRKT, MAP MOUNT, JGC	1
7J312-000	5/16 FLAT WASHER-SAE	2	4CL010-030	MAP SENSOR BLOCK, 07 CHARGER	1
7R005-001	CLAMP, T-BOLT, 208-91	1	4FR017-061	SPCR, H20 PIPE ASY, 03 MACH	1
4CK020-010	MANUAL, JEEP GRAND HEMI	1	5A002-017	MAP SENSOR, 07 CHARGER SC	1
4CK110-044	S/C MTG BRKT ASSY, JGC	1	7C010-077	10-24X3/4 BUTTON HD,CAP SCREW	2
008725	CAP, TAMPER PROOF, VORT S/C	2	7E010-150	#10 X 1.5" SHEET METAL SCREW	4
2A017-093	SPACER, S/C PULLEY, .093"	1	7F006-093	6MM NYLOCK NUT	1
2A017-102-181	SPACER, 1"OD X .406 ID X 1.809	1	7J250-001	1/4 WASHER, SAE, PLTD	1
2A017-105-197	SPACER, 1"OD, .328"ID, 1.974"L	6	7P062-187	1/16NPT X 3/16 HOSE BARB	1
2A017-105-198	SPACER, 1"OD, .328" ID, 1.974"L, STEPPED	1	7P250-045	1/4 MALE NPT X 3/8 MALE BARB	2
2A017-105-290	SPACER, 1.00" O.D. X .328" I.D. AL	2	7R001-006	#6 STNLS HOSE CLAMP, NARROW	5
2A017-154	SPACER, .154", IDLER BRG	1	7U031-016	5/16" PCV/VAC RUBBER HOSE	2'
2A017-375	SPACER, .375, C6, IDLER	2	7U032-016	3/8" EFI FUEL HSE HI-PSR	4'
2A036-333	S/C PULLEY 3.33" 6 GROOVE	1	8F060-008	FUEL INJ, 07 CHARGER SC	8
2A040-051	PLY RETAINER, TAMPER PRF CAP	2	5A003-050	DIABLO PREDATOR, HEMI	1
2A040-061	RETAINER CUP, VORT S/C PLY	2	5A102-032	ASSY, VOLT BOOST JEEP SRT8 G3	1
2A042-080	BELT, GATES 20MM, 80 TOOTH	1	5A002-031	VOLT BOOSTER HEMI G3	1
2D070-159	LARGE BEARING, EXTENDED DRIVE	2	5W001-021	1/2" SPLIT PLASTIC WIRE LOOM	7'
2D070-171	JACKSHAFT, C5, H900	1	5W001-005	3/8" SPLIT PLASTIC WIRE LOOM	11'
4CJ017-021	SPACER, .625" COIL	3	5W001-032	1/4" SPLIT PLASTIC WIRE LOOM	5'
4CK010-010	PLATE, HEAD MTG, 08 JGC	1	5W010-000	10GA RED STRANDED WIRE	19'
4CK010-020	BRKT, LOWER, IDLER-SC PLT, 08 JGC	1	5W012-010	12GA BLACK STRANDED WIRE	9'
4CK010-030	BRKT, UPPER, WTR PMP-SC PLT, 08 JGC	1	5W012-080	12GA ORANGE STRANDED WIRE	9'
4CK010-044	PLATE, SC MTG, 08 JGC	1	5W014-010	14GA RED STRANDED WIRE	9'
4GR032-032	PULLEY, JACKSHAFT, C5, 20MM, 32T	1	7U030-024	1/8" NYLON INSTRUMENT TUBING	20'
4GR116-300	IDLER ASSY, 20MM BELT	2	7P156-082	5/32" TEE	1
4NZ030-041	BRG HSG, 350Z	1	7U030-109	7/64" VAC HOST	.5'
7A312-152	5/16-18 X 1.5 SHCS, ZN PLT	4	7U100-044	4" NYLON TIE WRAPS	10
7A312-300	5/16-18 X 3" HXHD	1	7U100-055	7.5" NYLON TIE WRAPS	10
7A312-401	5/16-18 X 4" HXHD	2	5W001-014	FUSE HOLDER 10GA WIRE	1
7A312-675	5/16-18 X 6.75" STUD	2	7E010-048	#10 SHEET METAL PHILLIPS HEAD	3
7A375-300	3/8-16 X 3" HXCSG5P	1	7E010-075	#12 SHEET METAL HEX HEAD	2
7B375-075	3/8-24 X 3/4" GR8 HXHD BOLT	1	5W001-007	3/16 HEAT SHRINK	.75'
7B375-150	3/8-24X 1-1/2 GR8 HX	1	5W001-038	1/4 HEAT SHRINK	.75'
7C010-025	M10-1.5X25MM HXCP	1	5W001-043	10-12GA 1/4" YELLOW RING TERMINAL	1
7C010-162	M10 X 160MM STUD	1	5W001-041	10-12GA YELLOW SLIDE CONNECTOR MALE	2
7C012-022	M12 X 1.75 X 20MM THIN HD	3	5W001-040	10-12GA YELLOW SLIDE CONNECTOR FEMALE	3
7C012-065	M12 X 1.75 X 65MM HX	1	5W001-019	10-12GA YELLOW BUTT CONNECTOR	2
7C080-020	M8 X 1.25 X 20 HXHD, PLTD	1	5W001-009	14-16GA BLUE SLIDE CONNECTOR MALE	2
7C080-090	M8 X 1.25 X 90 HXHD CL 10.9	1	5W001-010	14-16GA BLUE SLIDE CONNECTOR FEMALE	3
7C080-100	M8 X 1.25 X 100 HXHD ZN PLT	1	5W001-013	14-16GA BLUE BUTT CONNECTOR	1
7F312-018	5/16-18 NUT USS PLTD	2	5W001-011	14-16GA BLUE RING TERMINAL	2
7G010-175	12MM X 1.75 NUT	1			
7GL10-150	10M X 1.5 NUT NYLOCK	1			
7J012-092	12MM WASHER, FLAT	2			
7J312-000	5/16 FLAT WASHER-SAE	8			
7J375-044	3/8 SAE WASHER, PLTD	3			
7U100-069	KEY, 3/16 SQUARE X .73 LONG	1			
7U100-073	KEY, 3/16 SQUARE X 1.375 LONG	1			
7U100-084	SNAP RING, V9	1			
7X100-027	WAVE WASHER-LARGE (V-2)	1			





# 2006-2010 Jeep Grand Cherokee

## Part No. 4CK218-020L/-028L

# PARTS LIST, CONT'D

**IMPORTANT:** Before beginning installation, verify that all parts are included in the kit. Report any shortages or damaged parts immediately.

**8N006-020 WATER COOLR, FLDYN DUAL PASS 1**

**8N105-270\* WATER TANK MTG ASSY, JGC 1**

4CK010-050	BRKT, CAC RAD MTG, JGC	2
4CK010-060	BRKT, WATER TANK, JGC	1
4CK010-070	BRKT, JGC PWR STR CLR, JGC	2
7A250-051	1/4-20 X .50 HHCS ZINC PLTD	8
7E010-075	#12 X 3/4" SHT METL SCRWR HEX	4
7F250-021	1/4-20 NYLOCK NUT ZINC PLATED	5
7J250-001	1/4 WASHER, SAE, PLTD	15
7J250-150	1/4" FENDER WASHER ZN PLTD	4
8N055-030	TANK, WATER, TRIANGLE SHAPE	1
7E010-100	#12 X 1.0" SHEET METAL SCREW	2
7U030-065	3/4"X90 RUBBER HOSE, SHORT	1
7P500-075	1/2NPT X 3/4 HOSE FIT STRT NICKEL	1
7A250-050	1/4-20 X .50 SHCS ZINC PLTD	5
7P500-026	1/2NPT X 3/4 BARB 90° BRASS	1
7P500-078	1/2NPT X 3/4 HOSE FIT STRT	1
7R007-001	NYLON RATCHET CLAMP 1-1/8"	12
7U038-000	3/4" HEATER HOSE	10'

**8N107-190 WATER PUMP MTG ASSY, 07 CHGR 1**

5W001-011	16-14 GA RING TERM .26" HOLE	1
5W001-013	14-16 GA BUTT CONN BLU INSUL	3
5W001-024	MINI ATC FUSE TAP	1
5W001-025	FEMALE SLIDE,INSULATED,MINI	1
5W001-054	18 GA FUSE HOLDER	1
5W014-030	14GA STRD WIRE BLACK	7'
7R003-027	ADEL CLAMP,1-11/16"	1
8F001-402	PUMP, WATER, PIERBURG	1

**4CK101-001 FUEL PUMP ASSY, JGC GSS 342 1**

5W001-013	14-16 GA BUTT CONN BLU INSUL	2
5W001-052	HARNESS, GSS 317 FUEL PUMP	1
7R004-001	STEPLESS CLAMP, 15.7-70	2
7R004-002	STEPLESS CLAMP, 17.0-70	1
7U032-018	3/8" SUBMERSIBLE EFI FUEL HOSE	12"
8F001-342	FUEL PUMP W/SCREEN,GSS 342	1
5W001-009	MALE SLIDE	2
5W001-010	FEMALE SLIDE	2
7P100-121	SEALING NUT	1
7P375-036	BULKHEAD FITTING	1
7U012-013	13X2MM O-RING	1





# 2006-2009 Grand Cherokee Tuner Kit

## Part No. 4CK218-120L/-128L

# PARTS LIST

**ENGINEERING, INC**

**IMPORTANT:** Before beginning installation, verify that all parts are included in the kit. Report any shortages or damaged parts immediately.

PART NO.	DESCRIPTION	QTY	PART NO.	DESCRIPTION	QTY
<b>008110</b>	<b>SMALL SILVER DIE CUT DECAL</b>	<b>2</b>			
<b>008130</b>	<b>LICENSE PLATE FRAME, VORTECH</b>	<b>1</b>			
<b>008341</b>	<b>POWERCOOLER DECAL</b>	<b>1</b>			
<b>008447</b>	<b>S/C STREET PACKAGE ASSEMBLY</b>	<b>1</b>			
<b>009035</b>	<b>S/C LUBE, BOTTLED, VORT 3-PACK</b>	<b>1</b>			
<b>2A046-975</b>	<b>BELT K060975, JEEP HEMI</b>	<b>1</b>			
<b>2F329-190(8)**</b>	<b>S/C ASSY, V3 CCW SI STR</b>	<b>1</b>			
	**SEE PREVIOUS BOM FOR ASSEMBLY COMPONENTS				
<b>4CK020-010</b>	<b>MANUAL, JEEP GRAND HEMI</b>	<b>1</b>			
<b>4CK110-044**</b>	<b>S/C MTG BRKT ASSY, JGC</b>	<b>1</b>			
	**SEE PREVIOUS BOM FOR ASSEMBLY COMPONENTS				
<b>4CK112-010</b>	<b>AIR INLET ASSY, HEMI JGC</b>	<b>1</b>			
4FU013-010	COVER, AIR FILTER, 05 MUST GT	1			
4GR012-011	DUCT, S/C INTAKE, MACH	1			
7P500-009	1/2" X 90 HOSE BARB UNION	1			
7R002-056	#56 SAE TYPE F SS HOSE CLAMP	2			
7S350-300	SLEEVE, 3-1/2 X 3, BLUE	1			
7U030-036	1/2" OIL DRAIN HOSE	6'			
8H040-050	AIR FILTER 3.5"FLG X 7"L	1			
<b>4CK112-020</b>	<b>AIR DISCHARGE ASSY, HEMI JGC</b>	<b>1</b>			
7R002-044	#44 SAE TYPE F SS HOSE CLAMP	3			
7R005-001	CLAMP, T-BOLT, 208-91	1			
7S275-192	ELBOW, 2.75 X 90 SILICONE TRIMMED	1			
7S350-278	ELBOW, 3.5X2.75 X 180° SILICONE	1			
7U030-046	5/32" VACUUM LINE	5'			
7U100-065	GROMMET,.5"ID,.812"OD,.187"GRV	1			
8H040-175	FILTER,1-3/4"ID.,MFRB	1			
8N055-050	PLASTIC CAP, SURGE TANK	1			
<b>4CL110-110</b>	<b>ASSY, DAMPER PIN HEMI</b>	<b>1</b>			
4GR010-110	GUIDE, DWL PIN IST, C5	1			
7C014-095	M14-1.5 X 95 MM SHCS	1			
7U250-019	DOWEL PIN,1/4D X 1/2L	1			
7U250-026	DRILL BUSHING, 1/4ID,.375OD	1			
<b>8D204-010(06)</b>	<b>RACE BYPASS VALVE-BLACK</b>	<b>1</b>			
<b>8N301-270(8)</b>	<b>WELDED CLR ASSY, HEMI JGC</b>	<b>1</b>			
<b>8N006-020</b>	<b>WATER COOLR, FLDYN DUAL PASS</b>	<b>1</b>			
<b>8N105-270</b>	<b>WATER TANK MTG ASSY, JGC</b>	<b>1</b>			
4CK010-050	BRKT, CAC RAD MTG, JGC	2			
4CK010-060	BRKT, WATER TANK, JGC	1			
4CK010-070	BRKT, JGC PWR STR CLR, JGC	2			
7A250-051	1/4-20 X .50 HHCS ZINC PLTD	8			
7E010-075	#12 X 3/4" SHT METL SCRW HEX	4			
7F250-021	1/4-20 NYLOCK NUT ZINC PLATED	5			
7J250-001	1/4 WASHER, SAE, PLTD	15			
7J250-150	1/4" FENDER WASHER ZN PLTD	4			
8N055-030	TANK, WATER, TRIANGLE SHAPE	1			
7E010-100	#12 X 1.0" SHEET METAL SCREW	2			
7U030-065	3/4"X90 RUBBER HOSE, SHORT	1			
7P500-075	1/2NPT X 3/4 HOSE FIT STRT NICKEL	1			
7A250-050	1/4-20 X .50 SHCS ZINC PLTD	5			
7P500-026	1/2NPT X 3/4 BARB 90° BRASS	1			
7P500-078	1/2NPT X 3/4 HOSE FIT STRT	1			
7R007-001	NYLON RATCHET CLAMP 1-1/8"	12			
7U038-000	3/4" HEATER HOSE	10'			
<b>8N107-190**</b>	<b>WATER PUMP MTG ASSY, 07 CHGR</b>	<b>1</b>			
	**SEE PREVIOUS BOM FOR ASSEMBLY COMPONENTS				
<b>4CK101-001</b>	<b>FUEL PUMP ASSY, JGC GSS 342</b>	<b>1</b>			
	**SEE PREVIOUS BOM FOR ASSEMBLY COMPONENTS				



## 1. PREPARATION AND REMOVAL

**NOTE:** It is recommended that this installation be performed when fuel level is below a quarter tank as the fuel tank will be removed in a later step.

- A. Disconnect negative cable at the battery.
- B. Remove the plastic engine cover and set aside.
- C. Remove the valve cover breather hose from the factory air inlet duct. Remove the air filter and all ducting up to the throttle body. Unplug the IAT (Inlet Air Temperature) sensor and remove it from the air filter housing. Set it aside for later use.

**NOTE:** For early model year vehicles whose coolant reservoir tops are black colored, a reservoir adjustment is required for proper installation clearance.

- Use the supplied spacer and M6 nut with washer located in fuel system assembly to space the fender mount tab away from the inner fender (See Fig. 1-a).
- Drill another 3/16" mounting hold in the shock tower to secure the relocated reservoir (See Fig. 1-b).

- D. Remove the radiator grille from the vehicle (only the 6 plastic fasteners on top of the radiator core support need to be removed to accomplish this).
- E. Remove the accessory drive belt.



Fig. 1-a



Fig. 1-b

## 2. HARMONIC DAMPER DOWEL PIN INSTALLATION

**NOTE:** The purpose of this section is to provide access to the harmonic damper bolt area so that the crankshaft can be pinned to the damper to prevent the damper from spinning on the crankshaft. The following steps will work on all or most applications. If it is not possible to get adequate clearance by performing the following steps, follow the manufacturer's steps for removing the harmonic damper until there is sufficient room to work in.

- A. Remove the crankshaft damper bolt. (A factory tool may be used to keep the engine from rotating or carefully use a pry tool to keep the damper from rotating.)
- B. Install the supplied drill guide with the raised section piloting in the damper bore. Secure in place by installing the supplied socket head cap screw. Do not over-tighten the screw as it may distort the drill guide (its purpose is just to hold the guide in place while drilling). See Fig. 2-a.
- C. Using a small drill motor (right angle pneumatic works well), mark a 1/4" drill bit with electrical tape or a drill stop so that the hole will be deep enough for the supplied 1/2" long dowel pin. See Fig. 2-b.
- D. Drill hole in damper/crankshaft.
- E. Remove the socket head cap screw.
- F. Clean area of metal chips and install the supplied dowel pin in the drilled hole making sure that it does not protrude past the damper face.
- G. Install and tighten the crankshaft damper bolt to 129 ft-lbs (176 Nm).



Fig. 2-a

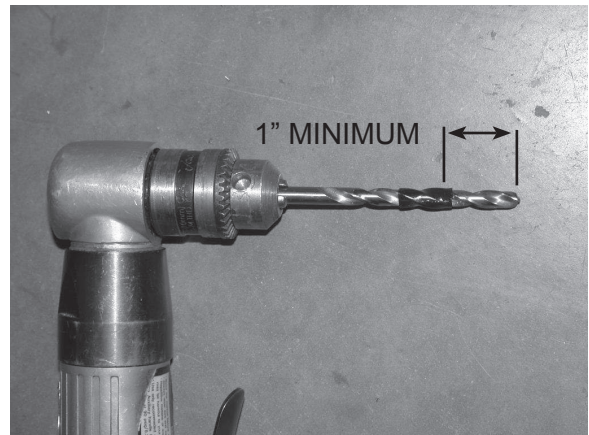


Fig. 2-b

### **3. FUEL INJECTOR REPLACEMENT**

- A. Relieve the fuel system pressure
- B. Disconnect the eight fuel injector plugs and retaining clips from the injectors.
- C. Remove the four screws that hold down the fuel rail on the intake manifold. Lift up on the rails evenly and remove all eight injectors.
- D. Using a small amount of clean motor oil, lightly lubricate the O-rings on both ends of the Vortech supplied fuel injectors. Install the factory injector retaining clips.
- E. Install the new injectors into the fuel rails with the terminals facing outward.
- F. Carefully lower the fuel rail/injector assembly down onto the intake manifold.
- G. Check to see that each injector has been seated properly into the intake manifold.
- H. Re-install both driver side fuel rail bolts and the front passenger side bolt. Set aside the remaining bolt as it will be used in a later step. Attach the injector plugs to the injectors.



## 4. SUPERCHARGER MOUNTING PLATE INSTALLATION

- A. Drain the engine coolant into a clean pan for later use.
- B. Remove the two bolts securing the thermostat housing and set all aside.
- C. Remove the alternator bolt. Loosely install the supplied M10 stud in its place.
- D. Cut off plastic wire loom push connector and discard (see Fig. 4-a).
- E. Loosen the wire loom on top of the valve cover so that the primary mounting plate can be installed flush with the front face of the head.
- F. Temporarily unplug the wires to the alternator if necessary. Cut the wire loom and separate the alternator wires so that they will reach the alternator.
- G. Loosely attach the primary mounting plate to the head with the recess pointed back using the supplied 8mm hardware as shown in Fig. 4-b.
- H. With the cog belt encircling the cog pulley, slide the slotted portion of the supercharger mounting plate assembly onto the 100mm bolt already installed and loosely attach it to the primary mounting plate using the 8mm hardware as shown in Fig. 4-d.
- I. Sandwich the supplied 1.97" spacers between the two plates at every location where there is a hole in the primary mounting plate. Note that one of the spacers has a flat and must be used in the lowermost hole to clear the water pump housing (See Fig. 4-b, 4-c).
- J. Be sure to keep all wiring loom below bracket and spacers to prevent from contacting cog drive. Use the supplied 5/16 x 6.75" long studs and 2.9" spacers at the location shown in Fig. 4-e.



Fig. 4-a

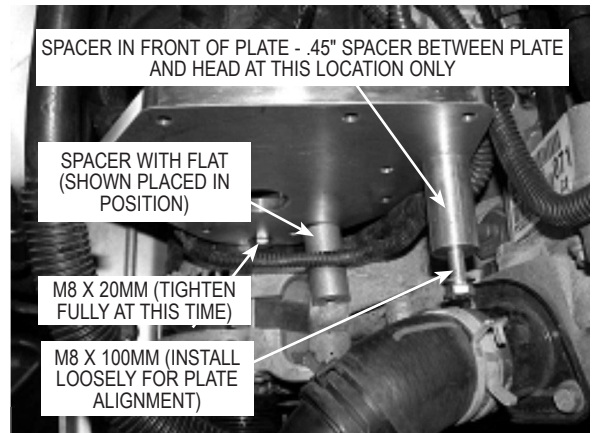


Fig. 4-b



Fig. 4-c

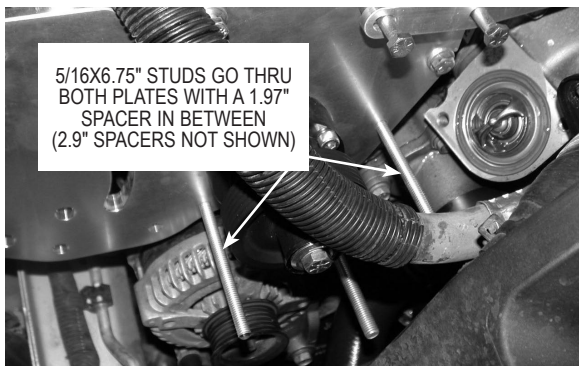


Fig. 4-e

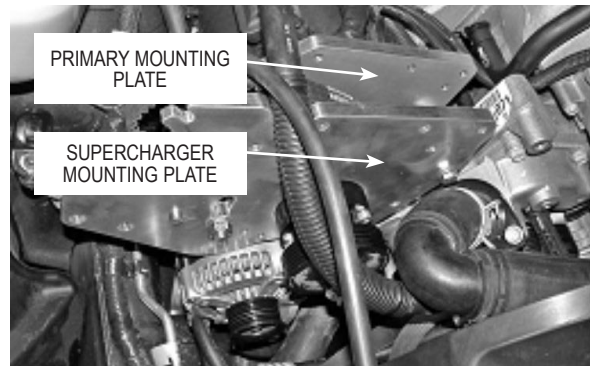


Fig. 4-d

- K. Loosely install the upper mounting bracket support using two .45" long spacers as shown in Fig. 4-f.
- L. Tighten the fasteners that go all the way through into the head first and then tighten the rest.
- M. Remove factory tensioner and replace with the supplied replacement tensioner in your kit.
- N. Per Fig. 4-h, install the supplied .15" thick spacer, one of the supplied aluminum idlers (with snap ring facing rearward), and one of the supplied .38" spacers onto the previously installed 10mm alternator stud.
- O. Install the lower mounting bracket support over the three previously installed studs as shown in Fig. 4-i.
- P. Recheck and tighten all of the mounting bracket hardware.
- Q. Retract the belt tensioner and install the six rib belt. Release belt tensioner.

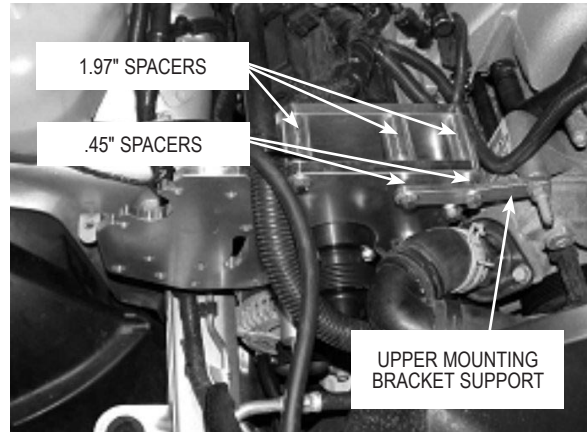


Fig. 4-f

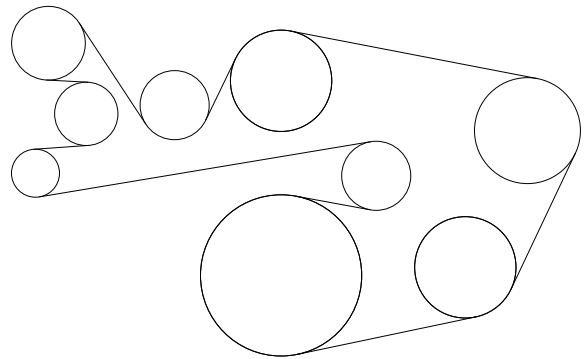


Fig. 4-g

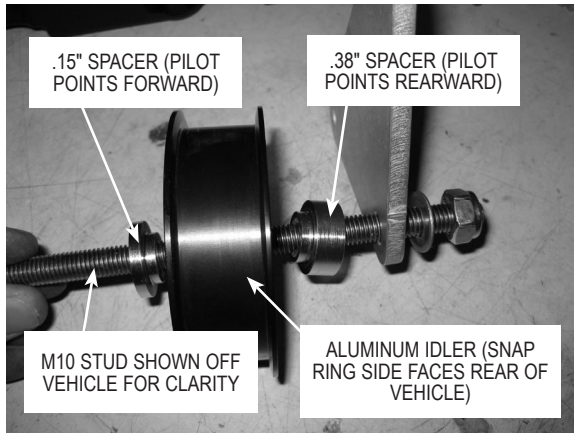


Fig. 4-h

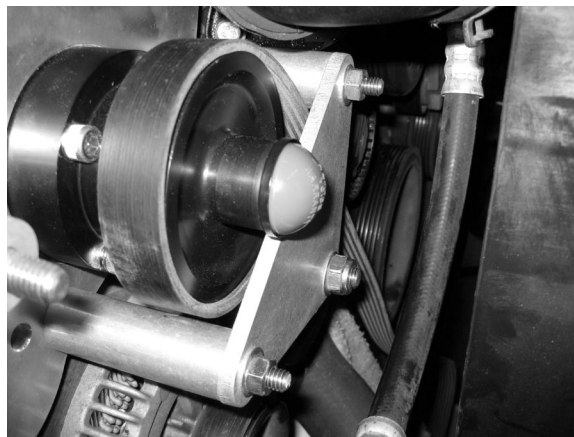


Fig. 4-j

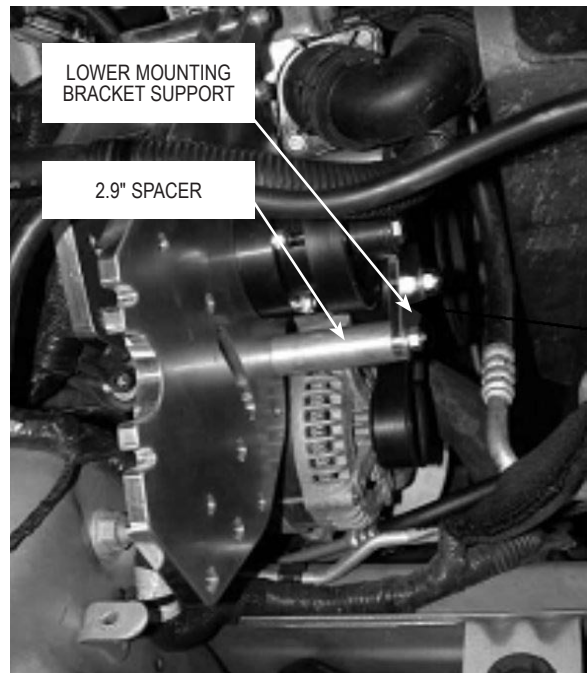


Fig. 4-i



## 5. SUPERCHARGER INSTALLATION

- A. Loosen the two bolts installed behind the supercharger pulley by hand until the bolt heads contact the supercharger pulley. Slide the bolt shoulders into the receiving slots in the supercharger mounting plate keeping the washers next to the bolt heads. Guide the cog belt around the supercharger pulley.
- B. Install the three 12mm thin-head bolts through the plate and into the lower part of the supercharger. Do not use washers.
- C. Install the 3/8" X 3" long bolt through the supercharger mounting plate, a 1.81" spacer and into the supercharger gearcase using the supplied washer (See Fig. 5-a).
- D. Tighten all six supercharger mounting bolts.
- E. Verify that the bearing snap ring on the supplied aluminum idler is pointing towards the mounting plate and the .375" spacer. Secure it to the slot in the supercharger mounting plate using the supplied 12mm hardware.
- F. Verify that the supplied cog belt is routed around both cog pulleys and above the smooth idler and tighten the idler so that the gilmer belt is snug (See Fig. 5-a).
- G. Secure the remote drain hose away from the belt and hoses using tie-wraps.
- H. Remove 3 forward most plastic rivets and the forward most reusable rivet holding passenger side inner fender liner to fender. Bend back inner fender liner to gain access to wheel well area.
- I. Be sure the supplied inlet duct to the supercharger inlet is oriented properly and tighten T-bolt clamp (See Fig. 5-b)

**NOTE:** Use caution when rotating the aluminum inlet duct. Careful heating with a propane torch will allow for easier rotation without galling the aluminum mating surfaces.

- J. Using the supplied 90° barbed fitting, attach the supplied 1/2" breather hose to the hole in the end-cap of the air filter. Route the 1/2" hose to the driver side valve cover and attach to the breather port.
- K. Install the air filter and air filter shield onto the long end of 3.5-inch pipe and install using 2 #56 clamps and 3.5-inch coupler to air inlet duct, orient for best clearance and tighten clamps on each connection.

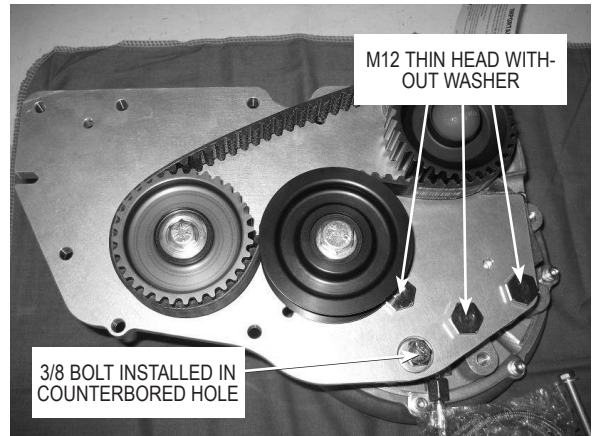


Fig. 5-a (Shown off the vehicle for clarity)

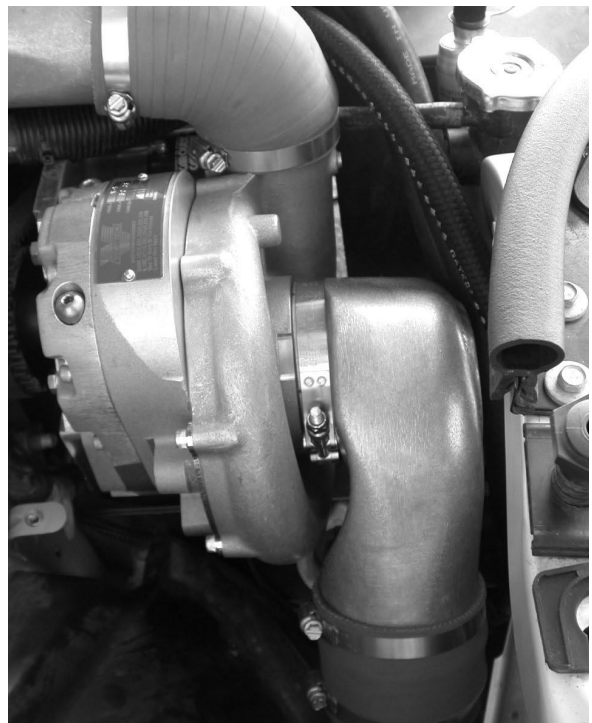


Fig. 5-b

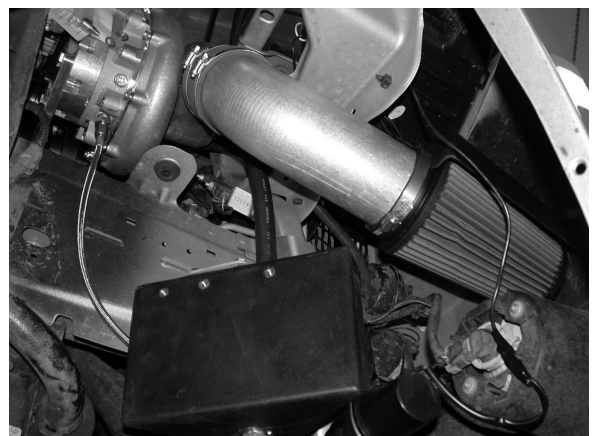


Fig. 5-c

## 6. ENGINE COOLANT HOSE MODIFICATION

- A. Remove the upper radiator hose from the thermostat housing.
- B. While the upper radiator hose is detached, rotate the two hose clamps on the short section so that they are pointed away from the drive assembly and bracket (See Fig. 6-a).
- C. Relocate upper A/C line to reside above radiator hose by first releasing it from support on front of water pump and then routing the upper radiator hose below it before re-attachment to the thermostat housing (See Fig. 6-b, 6-c).
- D. Re-install the upper coolant hose if removed.

**NOTE:** Rotation of the rubber coolant hose and elbow may be required for adequate clearance to the drive belt and assembly. Double check that hose clearance is adequate after clamps have been secured..

- E. Remove coolant "bleed" plug.
- F. Re-fill coolant system remembering to plug the "bleed" as soon as coolant comes out of it.
- G. Using the supplied 5/16" rubber line, route radiator overflow tube around supercharger and away from the blower drive pulley.

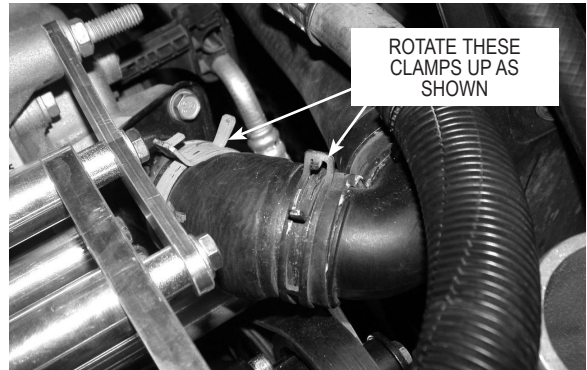


Fig. 6-a



Fig. 6-b



Fig. 6-c

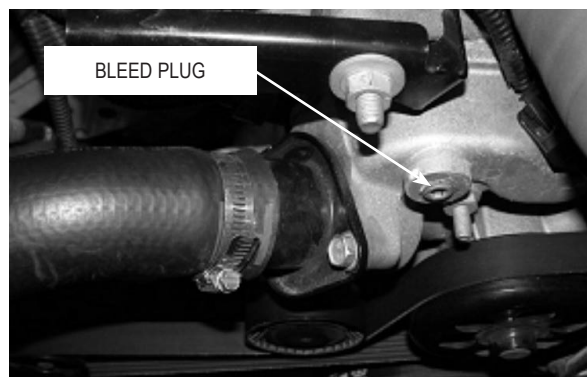


Fig. 6-d

## 7.A CHARGE AIR COOLER (CAC) INSTALLATION

1. Install a 1" long piece of the supplied  $\frac{3}{4}$ " hose over the end of the passenger side fuel rail (See Fig. 7A-a).
2. Using pipe thread sealant, install two  $\frac{1}{2}$ " NPT X  $\frac{3}{4}$ " barbed straight fittings into the upper and lower holes on the CAC end tank.
3. Install the supplied grommet into the hole in the CAC discharge tank, install IAT sensor, and plug it in.
4. Lower the CAC into place over the passenger side valve cover and loosely attach it to the supercharger and throttle body using the supplied silicone elbows. Using the 2.75 90° elbow, connect the short leg to the supercharger discharge and the other end to the left air tank on the CAC. Connect the 2.75-inch end of the 180° silicone hose to the right air tank on the CAC and the 3.5-inch end to the throttle body. Install the bypass valve using a gasket and the supplied hardware.



Fig. 7A-a



Fig. 7A-b



Fig. 7A-c



## 7.B CAC RESERVOIR AND WATER PUMP ASSEMBLY AND INSTALLATION

1. Using thread sealant, install 1/2" NPT 90° to 3/4 hose barb fitting into the Bottom of the reservoir and one straight 1/2" NPT to 3/4 hose barb fitting into the top of the supplied plastic reservoir.
2. Attach the water reservoir bracket to the reservoir using 1/4-20 x .5" cap screws.
3. Attach pump to reservoir using the supplied clamp and 1/4-20 screw in the orientation shown in Fig. 7B-e. Attach pump inlet to the bottom reservoir fitting using the supplied 90° hose and two nylon clamps.
4. Position the reservoir on the passenger side frame rail below the old air box location.
5. With the tank as far forward as possible measure 3 inches up from the bottom of the rail and mark the hole for drilling.
6. Drill two 11/64" holes for the supplied #12 sheet metal screws, install and tighten.
7. Cut off pump plug leaving as much wire connected to the pump as possible. Locate ground (brown) wire and attach a length of supplied black wire. Attach wire to sheet metal screw used to mount reservoir using the supplied ring terminal.
8. Connect a section of hose to the top of the reservoir and run it to the straight fitting installed in the upper hole of the CAC.
9. Connect the supplied fuse holder (lengthened with the supplied wire if necessary) to the water pump power wire using a butt connector. Route the water pump power wire across the bottom of the radiator and up to the fuse box and connect to fuse pictured in appropriate figure, using the supplied fuse tap and slide connector (if vehicle does not have a fuse in this area, or the water pump does not function, connect the power wire to any keyed power source).



Fig. 7B-a (2008-2009)



Fig. 7B-b (2005-2007)

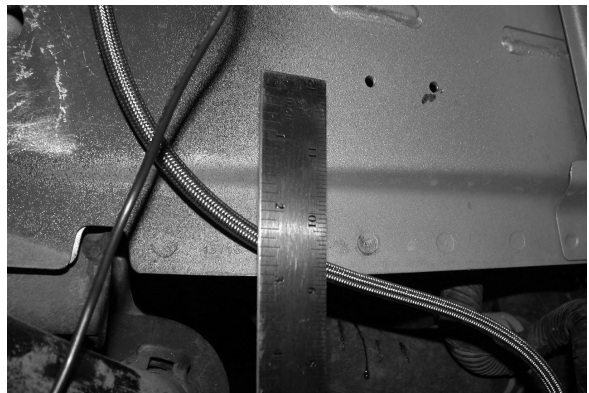


Fig. 7B-c



Fig. 7B-e

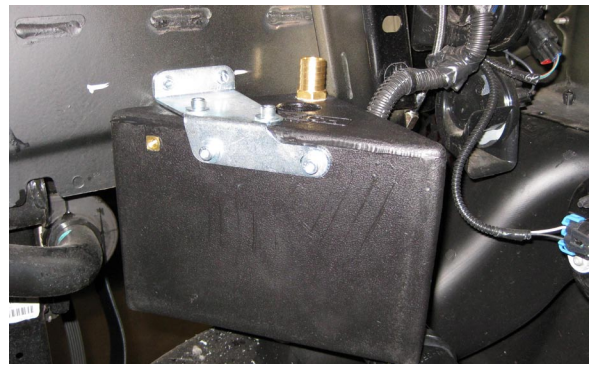


Fig. 7B-d

1. Remove the hood latch, core support brackets and power steering cooler from in front of the radiator. Pull firmly on the power steering cooler mounting clips until they come off.

**NOTE:** Early model year cars with core support brackets that do not bend in an arc will need to be replaced with new support bars available from your local dealer. (Ref PN 55394098AE). (See Fig. 7C-d)

2. Remove lower power steering hose from cooler and route below wiring harness. Re-install line to cooler using factory clamp.
3. Relocate the power steering cooler behind the bumper using the supplied brackets. Use the  $\frac{1}{4}$ " hardware to connect the brackets to the power steering cooler.
4. Mark and drill  $11/64$ " holes in the top of the metal bumper. Secure with #12 sheet metal screws.
5. Attach the supplied brackets to the CAC core using  $\frac{1}{4}$ " x  $\frac{1}{2}$ " long screws and washers. Remove the screws securing the ac condenser and mount CAC core using these screws in the middle hole in the bracket. Make sure that CAC core is mounted with passenger side outlet at the highest point.



Fig. 7C-a

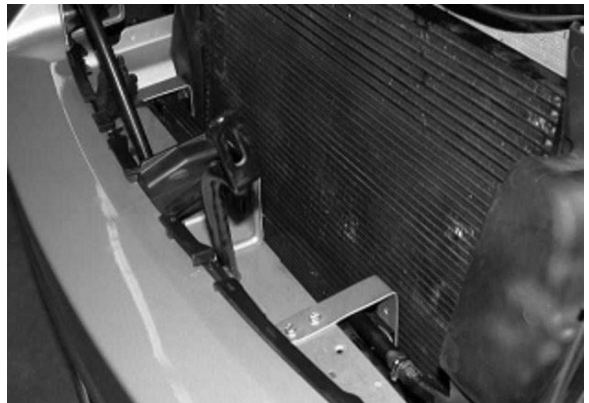


Fig. 7C-b

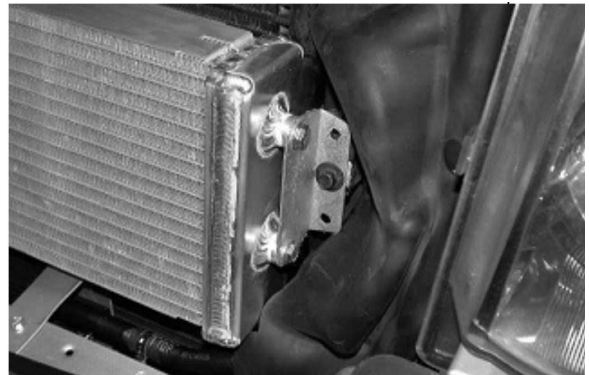


Fig. 7C-c



Fig. 7C-d



6. Install the supplied ¼" hardware in the passenger side upper hole where it lines up with the vehicle (See Fig. 7C-e).
7. Re-install the hood latch and core support brackets checking for clearance.
8. Connect the water pump discharge to the bottom hose barb on the CAC radiator using the supplied hose.
9. Connect the upper hose barb on the cooler radiator to the water inlet fitting in the bottom of the CAC core using the supplied hose. Be sure hose sweeps evenly as not to kink (see Fig. 7C-g).
10. Temporarily remove the hose from the top of the CAC core and fill hose with 25%/75% coolant/water mix until water comes out the fitting on the CAC core.
11. Re-attach hose, tighten clamps on all connections and check for leaks.
12. Re-install the front grille.

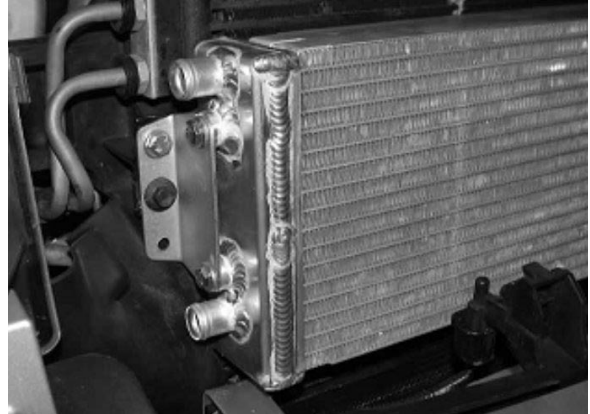


Fig. 7C-e



Fig. 7C-f

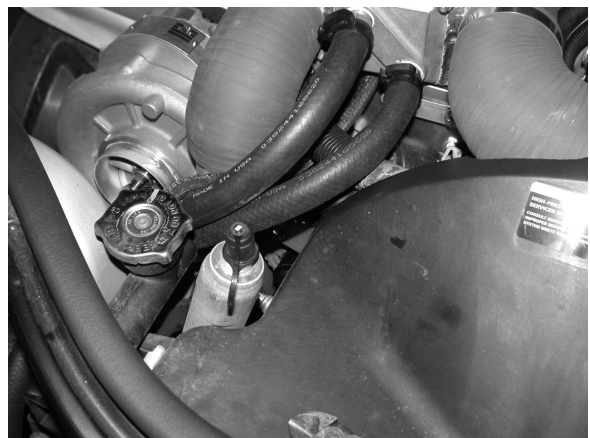
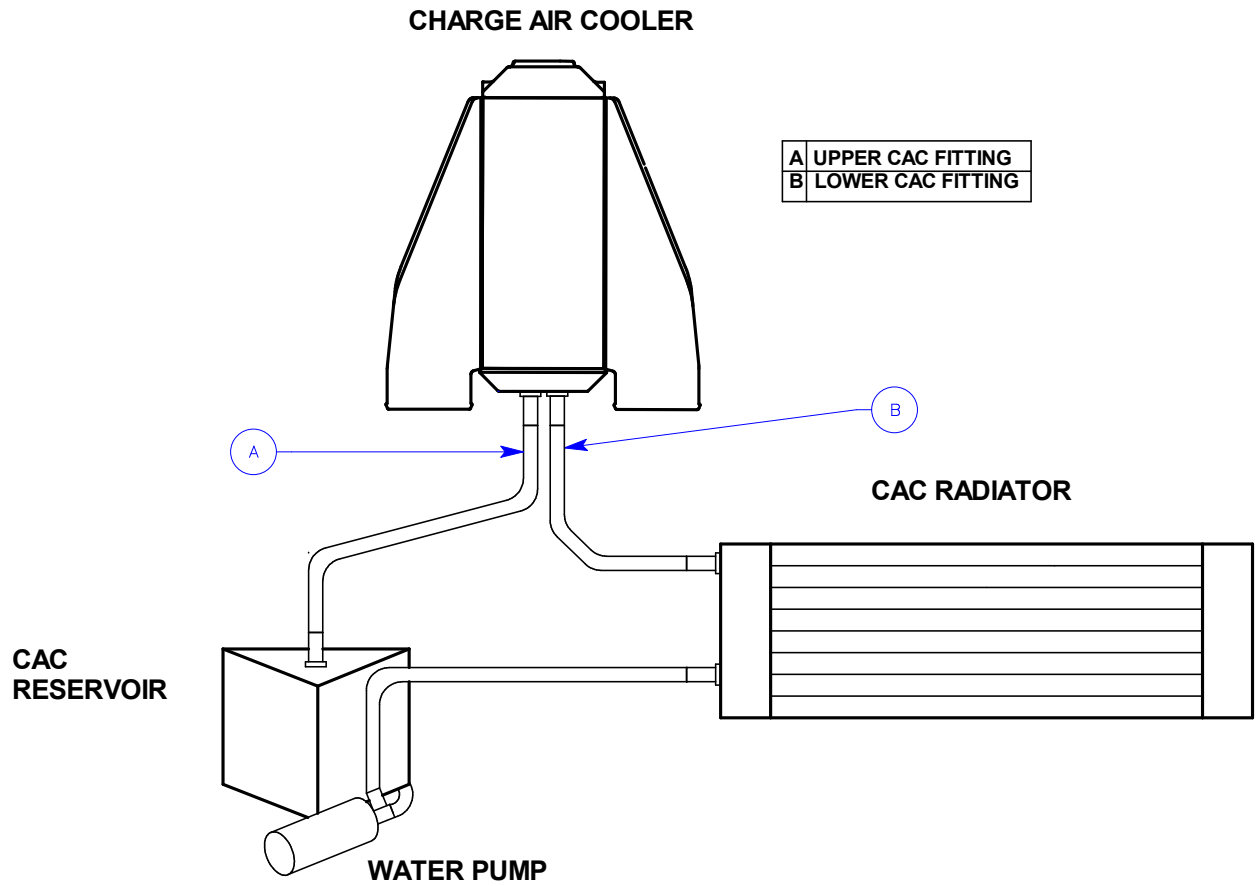


Fig. 7C-g

## 7.C CHARGE AIR COOLER RADIATOR INSTALLATION, CONT'D





## 8. SUPERCHARGER DISCHARGE ASSEMBLY INSTALLATION

- A. Using pipe thread sealants, thread the two 1/4 NPT to 3/8 barb fittings in either end of the map sensor block and the 1/16 barb fitting in appropriate hole.
- B. Assemble the supplied MAP sensor and MAP sensor bracket into the block using 10-24 screws. Unplug the factory MAP sensor and plug in the supplied MAP sensor. Factory MAP sensor is located at the back of the intake manifold and is most easily removed from the driver side.
- C. Attach map sensor assembly to the top of the rear passenger side fuel rail mount.
- D. Remove the 3/8" vacuum line from the brake booster fitting. Re-route the hose towards the passenger side of the motor and connect the line to the rear facing fitting on the map sensor. Connect the other fitting on the MAP sensor block back to the brake booster using the supplied 3/8" rubber hose. Install a supplied hose clamp on each connection.
- E. Connect 5/32" vacuum line from the bypass valve to the map sensor block fitting.
- F. Tighten clamps on the supplied  $\text{Ø}2.75"$  90° elbow that attaches the supercharger discharge to the CAC.
- G. Tighten clamps on the supplied  $\text{Ø}2\frac{3}{4}"$  to 3 1/2" 180° elbow that attaches the CAC to the throttle body (see Fig. 8-b for reference).
- H. It may be necessary to trim the vehicles plastic radiator shroud to provide proper clearance for the 180° silicone elbow.



Fig. 8-a



Fig. 8-b

## 9. FUEL PUMP INSTALLATION

**NOTE:** This section is easier when the tank is less than half full.

- A. Start by disconnecting the fuel supply and fuel vapor lines located just in front of the fuel tank. Disconnect by pushing connector forward slightly, and then while depressing the retainer clip tab as shown pull the connector back and off the hard metal line. (See Fig. a, Fig. b).

**NOTE:** Always use caution and use of safety goggles is recommended when disconnecting fuel lines that may be under pressure. Fuel will escape from connection. Take care to keep heat sources away.

- B. At the rear of the tank disconnect the two lines that go to the fuel vapor canister ( white connector and black connector with yellow clip). Disconnect the fill tube from the tank by loosening the clamp and separating the hose. (See Fig. c, Fig. d)



Fig. a



Fig. b



Fig. d



Fig. c

- C. Detach and unplug the fuel pump wiring harness located just above the center section of the rear axle.
- D. Support the tank using a transmission jack or equivalent. (See Fig. e)
- E. Locate and remove the six bolts mounting the fuel tank to the body. Disconnecting the drive shaft from the rear pinion flange by removing the 4 bolts will make removal of the tank easier. (See Fig. f)
- F. Carefully lower the tank down. Ensure that the fuel tank support brackets don't get hung up on the drive shaft. Some maneuvering of the tank is required.
- G. Once the tank is out make sure it is on stable surface. Dust off and clean up around the top of the fuel pump canister hole so that dirt doesn't get into the tank during the following steps.
- H. Disconnect the wiring harness at the top of the fuel pump canister. (See Fig. g)



Fig. e



Fig. f



Fig. g



- I. Using a brass or similar non-sparking metal punch or equivalent and hammer, tap the retaining ring in a counter clockwise direction. (See Fig. j1)
- J. Once the retaining ring is loose, disconnect the fuel feed line from the top of the fuel pump canister along with the retaining ring and set aside. (See Fig. j2.)

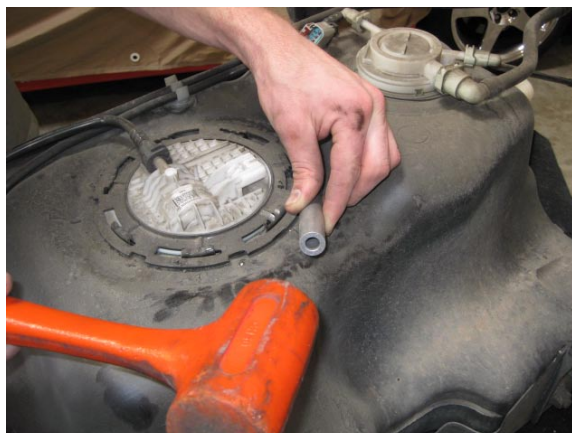


Fig. j1



Fig. j2

- K. Remove the pump assembly from the tank being careful not to damage or lose the rubber O-ring or the fuel level float and arm. (See Fig. k)
- L. Remove the electrical connection from the underside of the top of the canister (See Fig. l, Fig. m)



Fig. k

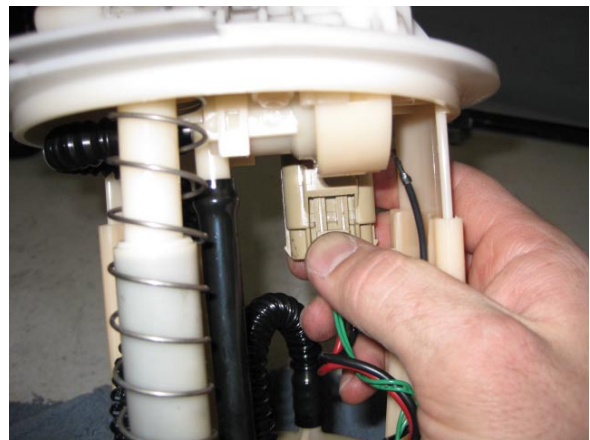


Fig. l



Fig. m

- M. Separate the two green signal wires from the side of the canister and make loose for separation of the canister. (See Fig. n)
- N. Separate the canister by gradually working around the unit, gently prying each snap clip until the two halves can be split. Be careful not to pull on the green wires to the fuel level sensor. (See Fig. o, Fig. p)



Fig. n



Fig. o

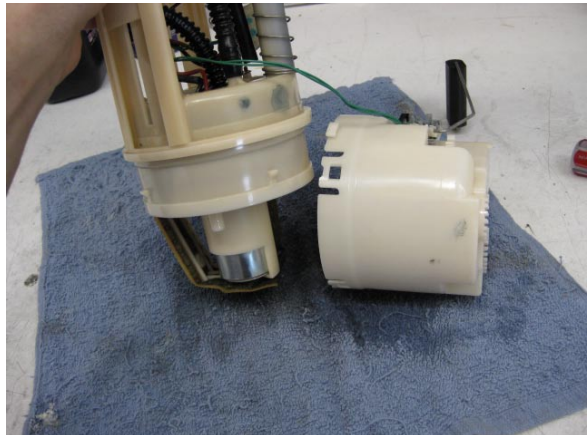


Fig. p

- O. Using a flat screwdriver, carefully separate the filter from the bottom of the fuel pump. This filter will be reused on the new pump at a later step. (See Fig. q, Fig. r)
- P. Detach the black corrugated fuel line that connects the fuel pump to the canister at the canister side by gently slitting the line along the barbs as shown with a razor blade. (See Fig. s.)



Fig. q



Fig. r



Fig. s



- Q. Separate the top lid from the center section of the fuel pump canister by carefully disengaging the retainer tab on the two flat arms connecting them. (See Fig. t, Fig. u)
- R. Remove the factory pump from the canister by first pushing up on the bottom of the stock pump. Push it out of its cavity using a small screwdriver. If necessary, disconnect the terminal connections at the top of the pump. (See Fig. v, Fig. w)

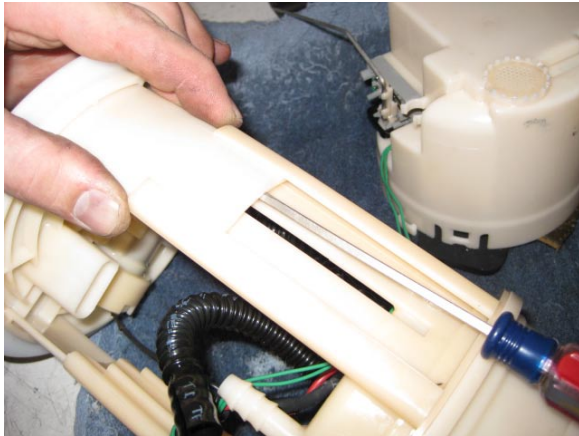


Fig. t



Fig. u



Fig. v



Fig. w

- S. Locate the supplied fuel pump. (See Fig. x)
- T. Modification to the bottom of the pump is required for it to sit properly in the canister. Keeping the dust cap in place, carefully remove the two of the four plastic tabs closest to the fuel pickup port, by either shaving them flush with a razor blade or with a small die grinder. (See Fig. y.)



Fig. x



Fig. y

- U. Slide the two supplied 15.7 stepless clamps onto the one end of the supplied submersible rubber fuel hose and then slide the end over the fuel pump discharge. Secure the 15.7 stepless clamps as shown. (See Fig. ac1, ac2)

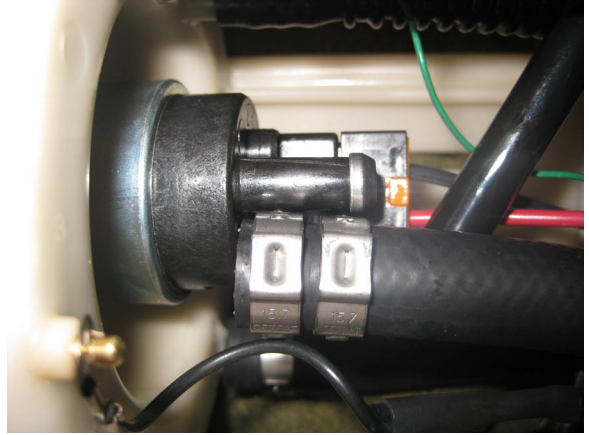


Fig. ac1



Fig. ac2

- AA. On underside of fuel pump canister lid, locate the square recess as depicted in fig ag1.
- AB. Mark the square recess as depicted in fig ag2 and drill through with an 1/8" drill bit. See fig ag3.

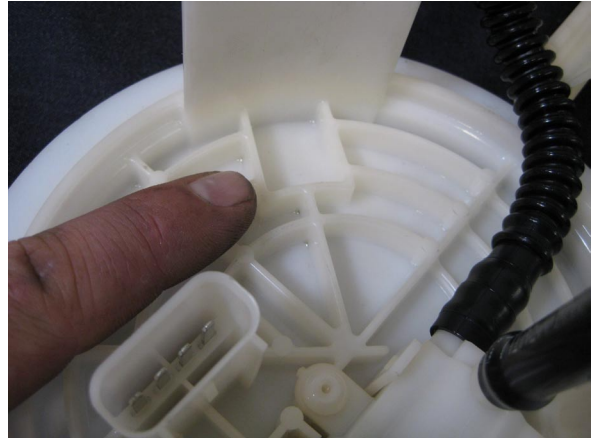


Fig. ag1



Fig. ag2



Fig. ag3

AC. On the top side of the lid the previously drilled hole should appear as shown in fig ag4. Using a fine grit/grade file or grinder, remove the webbing surrounding the hole so that a flat and smooth surface remains. See fig ag5.

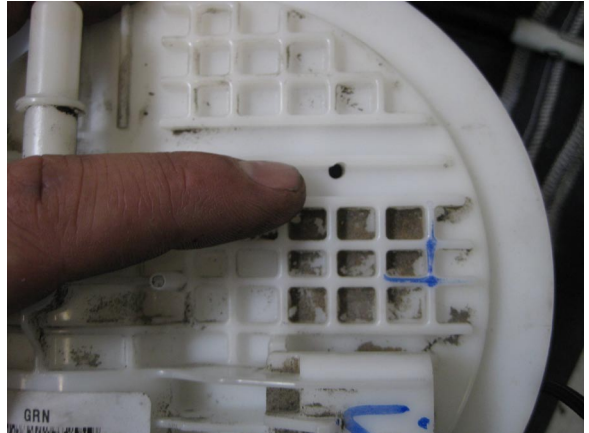


Fig. ag4

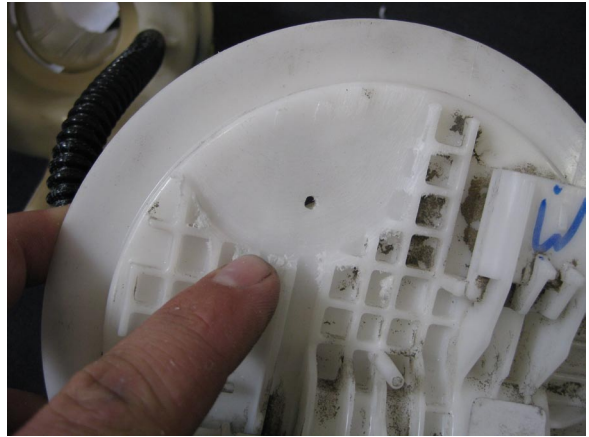


Fig. ag5



- AD. Enlarge the 1/8" pilot hole to 43/64" stepping up in gradual increments and taking care not to crack the lid. Using cutters, carefully remove the surrounding webbing from the underside of the lid so the supplied bulkhead sealing nut can sit flush. See fig ag6.
- AE. Insert the bulkhead through the top of the lid and secure it by installing and tightening the bottom nut as seen in fig. ag7.

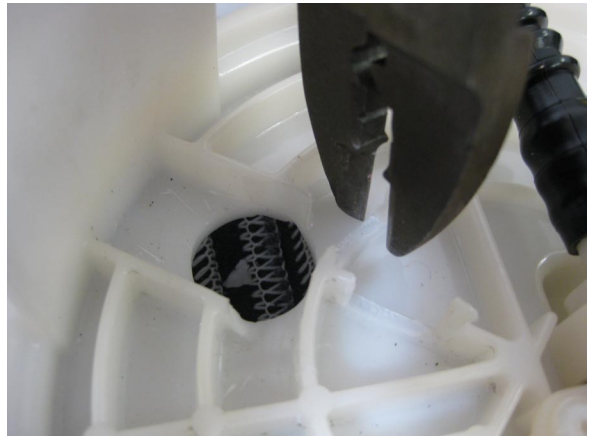


Fig. ag6

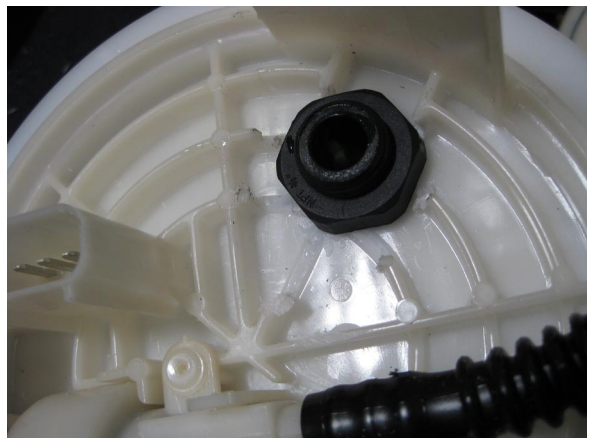


Fig. ag7

- AF. Locate supplied pump connector and pass the wires through the bulkhead. Loosen top nut on bulkhead to allow adjustment of pump plug wire length (See fig ag8). Attach a male slide connector to the end of the red wire and a female slide to end of the black wire.
- AG. Locate factory pump plug on underside of lid and cut the red power wire as close to the plug as possible (See fig ag9). Trim black fuel pump ground wire just below where the smaller black wire tees into the larger black wire. See fig ag10.



Fig. ag8

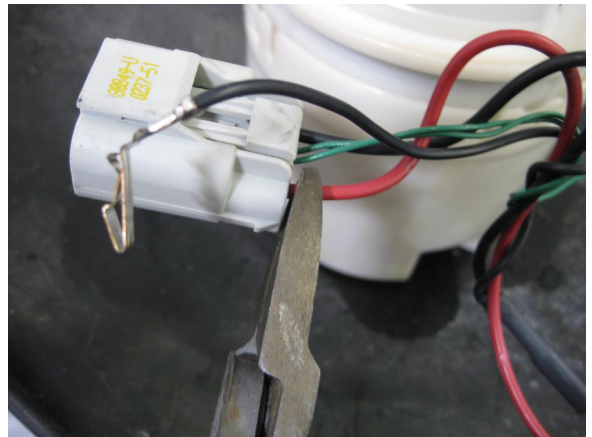


Fig. ag9



Fig. ag10



AH. Install the fuel pump into the center cavity of the canister being sure to orient the fuel inlet as shown. Install the previously removed filter by pressing it on to the new pump inlet. Attach the new electrical connector into the top of the pump. After plug is attached to pump, tighten top nut on bulkhead. (See Fig. ai, Fig. ak, Fig. al, Fig. am)



Fig. al



Fig. ai



Fig. am



Fig. ak

- AI. Re-assemble the top lid to the canister, and the lower bucket to the middle section of the fuel pump canister being sure that the fuel filter pad is positioned appropriately. Make sure that the o-ring is installed on the middle section of the discharge and aligned properly with the riser located in the bucket during reassembly. Lubricate the o-ring with a drop of clean motor oil to ensure the o-ring doesn't tear or bind during re-assembly. (See Fig. ao, Fig. ap)

**NOTE:** It is important to be sure that the o-ring is properly seated and sealed during re-assembly of the bucket as failure to do so may result in insufficient fuel pressure at wide open throttle.

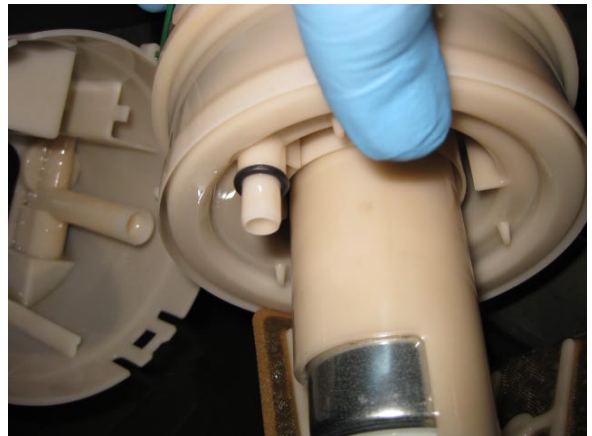


Fig. ap



Fig. ao

- AJ. Re-connect the factory electrical connector to the underside of the fuel canister lid using dielectric grease on the plug terminals.
- AK. Onto the free end of the new fuel line slide a stepless 17.0 clamp. Install fuel line to the barb located on the middle section of the fuel canister and tighten clamp (See Fig. as). Trim rubber hose for best fit.
- AL. Compress the lid down and make sure that the fuel lines and wires will be free of kinks once the canister is re-installed.
- AM. Re-install the newly assembled fuel pump canister back into the tank using the original o-ring gasket. Be sure to orient the unit so that the locating tab lines up with the arrow and the fuel connection points towards the appropriate side of the tank. (See Fig. aw)

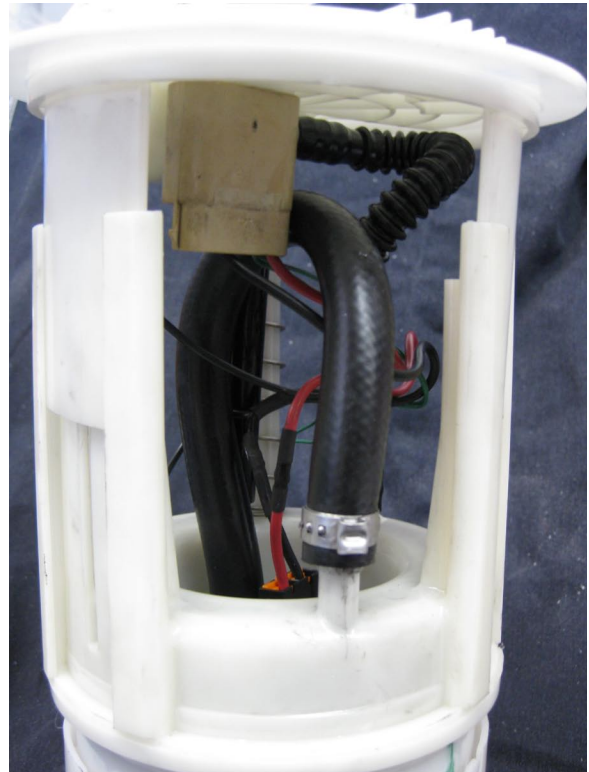


Fig. as



Fig. aw

- AN. While pressing down on the lid, re-install the canister retaining ring using a brass or similar non-sparking metal punch and hammer.
- AO. Tap the retaining ring in a clockwise direction until the raised notches are located with the appropriate raised notch of each of the tanks brackets. (See Fig. p, Fig. q)
- AP. Squeeze a small amount of dielectric grease into each pin location of the connector that connects to the external receiver of the fuel pump canister lid.
- AQ. Connect the fuel feed line to the top of the pump canister unit.



Fig. p



Fig. q



## 10. FUEL PUMP VOLTAGE BOOSTER INSTALLATION

- A. Be sure the battery is disconnected.
- B. Remove front driver side wheel and remove 2 rear most plastic rivets and rear most reusable rivet securing plastic inner fender liner. Bend inner fender liner forward.
- C. Gain access to the firewall right below the brake master cylinder booster. (See Fig. b)



*Fig. a*



*Fig. b*

- D. Open rear hatch door of vehicle to gain access to FPB mounting location. Remove the bottom plastic trim panel piece along bottom edge at latch. Remove two 10mm nuts and lift up subfloor to gain access to FPB mounting location.
- E. Place FPB in the mounting location lowering subfloor to confirm location and fit. Mark mounting location and cut away insulation mat. (See Fig. c)
- F. Position the FPB unit as shown in Fig. 10-d and mark the three mounting holes for drilling.
- G. Using a drill with a 9/64" drill, drill 3 mounting holes.
- H. Mount the FPB unit to the floor using the three #10 sheet metal Phillips head screws. (See Fig. e)



Fig. c



Fig. d



Fig. e



- I. Locate the 1/8" nylon Instrument tubing, 10ga. red wire, 12ga. orange wire, 14ga. red wire, and install it into the 1/2" plastic split loom making a harness assembly.
- J. Locate the rubber plug shown in Fig. f and Fig. g. Using a sharp knife or blade cut the bottom out of the plug to provide through access for 1/2" harness assembly.
- K. From the underside of the vehicle route the harness assembly up through the modified plug to the FPB previously installed. Secure the loom with provided tie wraps in Fig. f.
- L. Locate the 11' piece of 3/8" plastic split loom and install the 1/8" nylon instrument tube and red 10ga. power wire. Continue routing the harness assembly loom (See Fig. h, Fig. i) through the factory fuel line supports along the inside of the underbody and secure with zip ties as needed. Leave the 12ga. orange and 14ga. red wire hanging as shown in Fig. h to be used in a later step.



Fig. f

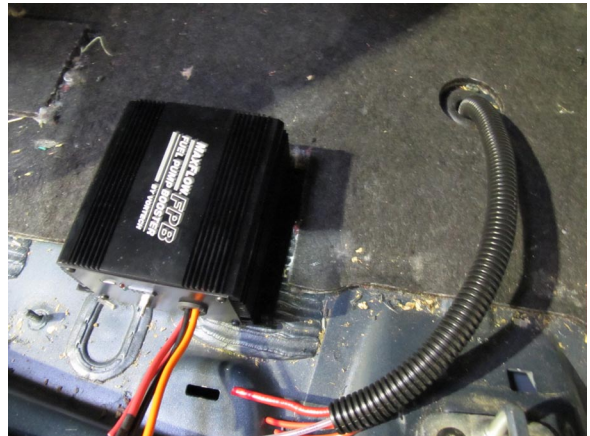


Fig. g



Fig. i



Fig. h

- M. Continue routing harness along transmission cross member, (See Fig. j, Fig. k, Fig l) and continue routing the harness further forward up and through the oblong hole under the brake booster in the firewall and up and into the engine bay. (See Figs. m)

**NOTE:** Crimp on connectors are provided but it is recommended that all of the wire connections be soldered and insulated.

**NOTE:** Refer to the fuel pump wiring diagram that is provided for further explanation if needed.



*Fig. j*



*Fig. k*



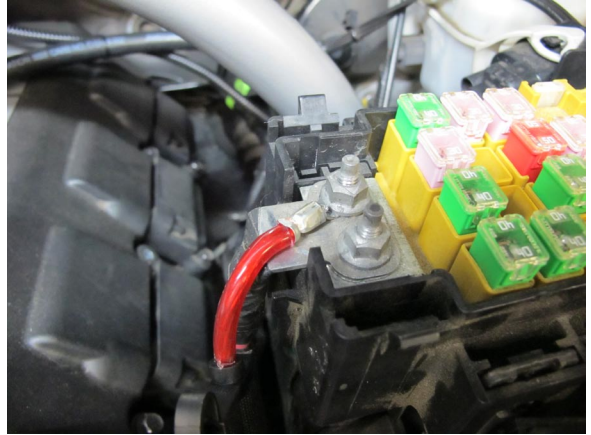
*Fig. l*



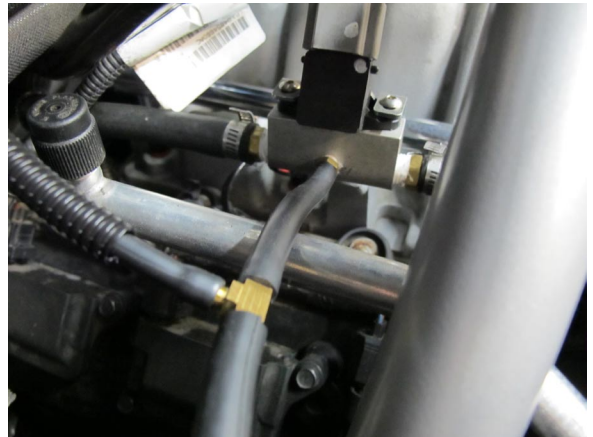
*Fig. m*



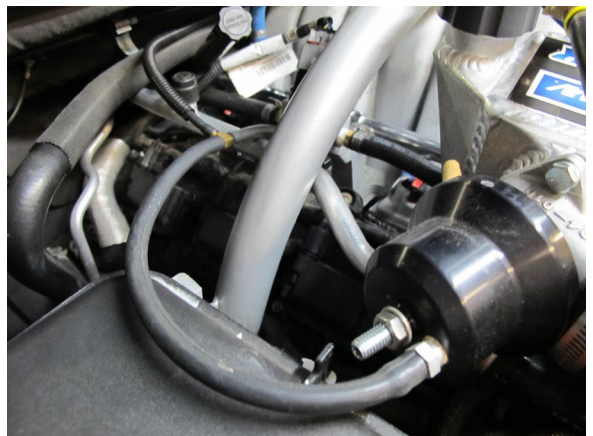
- N. Continue running the red 10ga. power wire to the Power Distribution Center. Locate the provided fuse holder and cut the center of the wire loop. Attach one end to the red 10ga. power wire from FPB. Use the supplied  $\frac{1}{4}$ " yellow ring terminal crimp, solder, and attach to factory power lug. (See Fig. n) Install the supplied 40amp fuse into fuse holder after all connections are complete and cover the wire with a piece of  $\frac{1}{4}$ " plastic split loom. (Refer to wiring diagram).
- O. Run the  $\frac{1}{8}$ " instrument tube vacuum line from the FPB to the passenger side of the engine. Locate the supplied  $\frac{7}{64}$ " vacuum hose and cut off a 2" piece. Slide approx. 1" onto the  $\frac{1}{8}$ " nylon instrument tube.
- P. Using the supplied brass fitting, connect the FPB vacuum line to the line between the MAP sensor and bypass valve. (See Fig. o, and Fig. p). Cover with  $\frac{1}{4}$ " plastic split loom and secure with the provided tie wraps. This will be used for boost reference.



*Fig. n*

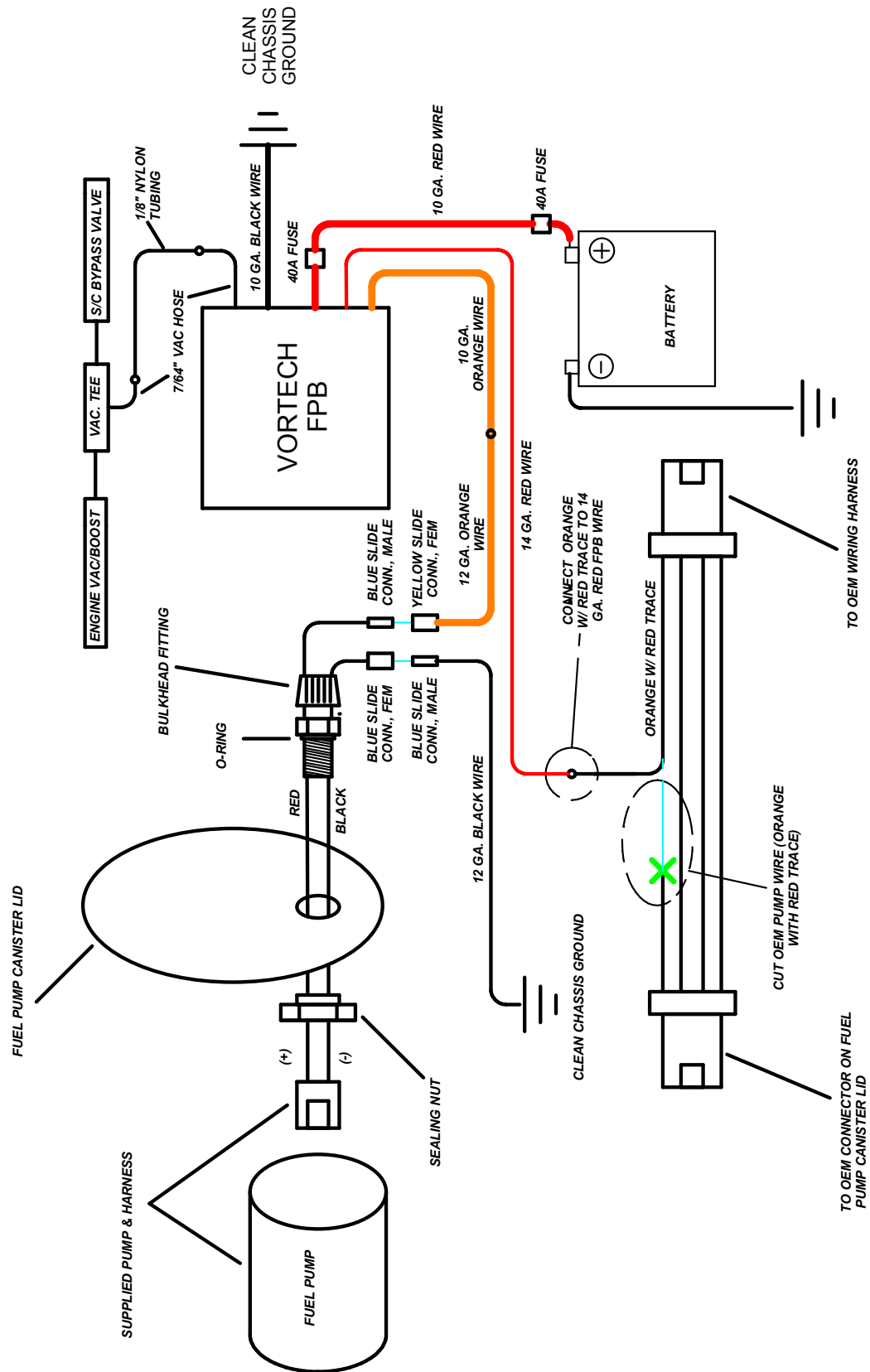


*Fig. o*



*Fig. p*

# Wiring Diagram





- Q. On the FPB box locate the red 10ga. wire with a fuse holder. Connect this wire to the 10ga. red wire in the harness assembled back in step I. (See Fig. d). Connect the 10ga. orange wire from the FPB to the 12ga. orange wire in the harness. Connect the 14ga. red wire from the FPB to the 14ga. red wire in the harness. Locate the 7/64 vacuum hose provided in the kit and cut a 2" piece and install one end on the 1/8" nylon tube and the other end to the vacuum port on the FPB. This will be used for boost reference. Locate the black 12ga. ground wire from the FPB and install a 1/4" ring terminal. Using a drill with a 9/64" bit, drill a hole and attach the black ground wire to a suitable ground as shown in Fig. q, and r. (Refer to wiring diagram). Install the supplied 40amp fuse into fuse holder.
- R. Reassemble the subfloor and plastic trim panel. (See Fig s)



Fig. q



Fig. r



Fig. s

- S. Locate the factory fuel pump wiring harness disconnected from the fuel pump canister in step 9-H. Peel back the electrical tape toward the end that plugs into the pump canister. Cut the orange wire with the red tracer roughly 3 inches from the plug (see Fig. t).
- T. Bundle wires together and wrap with electrical tape (See Fig t). Refer to wiring diagram for final installation.
- U. Trim the FPB red and orange wires left hanging (shown in Fig. h, page 33) so that there is adequate length to connect to fuel tank during re-assembly. Attach the 14ga. red wire from the FPB to the end of the orange with red trace wire going to the OEM wiring harness. (Refer to wiring diagram). Attach a female slide connector to the 12ga. orange wire from the FPB. This wire will power the fuel pump.
- V. Locate the 3 foot piece of 12ga. black ground wire supplied in your kit. Attach a male slide connector to one end and a 1/4" ring terminal to the other end. Attach the ring terminal to the chassis using the supplied sheet metal screw. (See Fig. u)



Fig. t

## INSTALL FUEL TANK

- AA. Re-support tank on transmission jack or equivalent and carefully raise tank back up into the cavity of the car. Connect the harness that was spliced into the FPB wires to the fuel pump canister. Connect the orange FPB wire to the red pump wire and black ground wire to the black pump ground wire. Raise the tank all the way. Some maneuvering is required if the driveshaft was not disconnected.
- AB. Secure with original six bolts.
- AC. Reconnect the fuel tank filler tube with original clamp, the two push lock connectors at the rear of the tank to the fuel vapor canister (white connector and black connector with yellow clip)
- AD. Reconnect the electrical connector located above the rear differential center section.
- AE. Reconnect the two push lock connectors located at the front of the tank. (Fuel supply and fuel vapor lines)
- AF. Re-secure inter fenders and re-install front wheel.
- AG. Connect the battery. After reconnecting the battery you should key on listening for the pump to prime and check all fuel connections for leaks.



Fig. u

## 11. REFLASH COMPUTER

**IMPORTANT!** To ensure trouble-free programming of your vehicle's computer:

- Make sure the vehicle's battery is sufficiently charged.
- Turn off all accessories and close doors to prevent unnecessary drain on the battery.
- Do not attempt to program your vehicle while a battery charger is connected.
- Improper battery voltage will result in failure of the programming process.
- Do not disconnect the cable or turn off the ignition during programming.

- Reconnect the battery.
- Locate the vehicle's OBD2 connector located below the dash on the driver's side of the vehicle.
- Attach the OBD2 connector from the Flash tool that is provided in the kit to the vehicle's OBD2 port. Make sure this connector is seated all the way in the vehicle's OBD2 port. You do not want this connector coming out during programming or damage may occur to the vehicle's ECM.
- The Reflash tool should power up and display three parameters.
  - Performance Tune
  - Diagnostics
  - Options
- Select "Performance Tune" and press the enter button in the middle of the arrow keys.
- Read the disclaimer entirely, then select agree and press ENTER.
- At this point follow the instructions on the screen displayed on the reflash tool. If you have any questions, either refer to the manual that is provided with the reflash tool or contact our service department for further assistance.
- Turn the ignition on (do not start the vehicle). Set the parking brake and press the ENTER button to continue.

**NOTE:** Do not disturb the cable, or turn the ignition off during this time. If the programming is disrupted, the computer will not start or run your vehicle!

- SELECT TUNE will be displayed at the top of the screen. Use the arrow keys to select the appropriate tune for your vehicle and press the ENTER button. You will have a choice of two to choose from:
  - Vortech (used for installing kit)
  - Original Backup
- Continue to follow the screen and when finished, unplug the reflash tool from the vehicle's OBD2 port.



Fig. a

## 12. FINAL ASSEMBLY AND CHECK

**NOTE:** THIS SUPERCHARGER HAS BEEN FACTORY PRE-FILLED WITH SPECIAL SYNTHETIC LUBRICANT. OIL DOES NOT NEED TO BE ADDED TO A BRAND NEW UNIT. HOWEVER THE FOLLOWING FLUID LEVEL CHECK SHOULD BE PERFORMED.

- A. Remove the factory installed flat head brass shipping plug (not the dipstick) from the top of the supercharger case.
- B. Replace the sealed shipping plug with the supplied “vented” plug. Do not operate the supercharger without it.
- C. Ensure that the .06” copper sealing washer is located on the dipstick base.
- D. Thread the clean dipstick into the supercharger until it seats.
- E. Once the dipstick has seated, remove the dipstick from the unit. Fluid should register in the crosshatched area on the dipstick.
- F. **DO NOT OVERFILL!!** Drain excess fluid from the unit if it is above the maximum level on the dipstick. Install and tighten the dipstick in the gearcase.
- G. If your vehicle has gone over 20,000 miles since its last spark plug change, it is a good idea to change the spark plugs now, before test-driving.
- H. Make sure that the vehicle is filled with 91 octane or higher fuel before commencing test drive.
- I. With key on, make sure charge air cooler water pump is operating and that water is flowing through the surge tank. Fill as necessary. If water is not flowing, remove the hose from the bottom of the surge tank and lower until water flows out of hose. This should prime the pump. Reconnect hose, verify water flow and top off surge tank. Do not run the water pump for extended periods (30 seconds or more) without water flow.
- J. Check all fittings, nuts, bolt and clamps for tightness.

**WARNING:** Do not attempt to operate the vehicle until ALL components are installed and ALL operations are completed including final check. Failure to do so may cause PREMATURE FAILURE OF MAJOR COMPONENTS.

- K. At this point it is OK to start the vehicle.
- L. With engine running, check power steering hose connections for leakage. Let engine run for two minutes. Turn steering wheel in both directions.



Verify:

- Smooth power assist
  - Noiseless operation
  - Proper fluid level
  - No system leaks
  - No bubbles, foam or discoloration in fluid
- M. Verify that the gilmer belt is running smoothly. If wear is detected on the side of the belt, it is probably too tight. If it is vibrating excessively, tighten until there is minimal movement.
- N. Turn off vehicle and recheck all fluid levels and verify that no hoses, wires, etc. are near exhaust headers or moving parts and that there is no fluid leakage.
- O. Be sure both front fender liners are secured w/ supplied pull lock pins.
- P. Test drive vehicle by gradually working up to full throttle and paying close attention to any abnormal sounds or engine detonation.

**NOTE:** Read the STREET SUPERCHARGER SYSTEM OWNER'S MANUAL AND RETURN THE WARRANTY REGISTRATION FORM within thirty (30) days of purchasing your supercharger system to qualify for the 3 year limited warranty.

## **For Internally Lubricated V-3 Units Only**

### **Important Information About Supercharger Maintenance:**

#### **Long term maintenance and care:**

- CAUTION: Use of any fluid other than the Vortech supplied synthetic lubricating fluid will void the warranty and may cause component failure.
- Replacement Vortech V-3 lubricating fluid part number: 009035 - Package of three 4 oz. bottles
- Check the fluid level using the dipstick at least every 2,500 miles.  
Initial supercharger fluid change must be performed at 2,500 miles. The supercharger fluid must then be changed at least every 7,500 miles.
  1. Drain the fluid, re-fill the unit only with 4 oz. of Vortech supplied synthetic lubricating fluid.
  2. Confirm proper oil level using the dipstick. DO NOT OVERFILL!! (See steps 12-C through 12-F)

#### **Supercharger fluid level checking procedure:**

1. Ensure that the .06" copper sealing washer is located on the dipstick base.
2. Thread the clean dipstick into the supercharger unit it seats.
3. Once the dipstick has seated, remove the dipstick from the unit. Fluid should register in the crosshatched area on the dipstick.
4. DO NOT OVERFILL!!! Drain excess fluid the unit if it is above the maximum level on the dipstick.



**ENGINEERING, INC**

1650 PACIFIC AVENUE • CHANNEL ISLANDS, CA 93033-9901 • (805) 247-0226  
FAX (805) 247-0669 • [www.vortechsuperchargers.com](http://www.vortechsuperchargers.com) • M-F 8:00 AM - 4:30 PM PST