

# MAGNUSON

## SUPERCHARGERS

Installation Instructions for:  
**Radix Max**

Intercooled Supercharger System  
2015-17 GM 6.0L 2500 HD



Step-by-step instructions for installing the best in  
supercharger systems.

**\* PREMIUM GASOLINE FUEL REQUIRED \***

**ATTENTION!**

Your **MAGNUSON SUPERCHARGER** kit  
is sensitive to corrosion!

**Use only the vehicle manufacturer  
recommended coolant for your engine in  
the intercooler system as well.**



Magnuson Products LLC  
1990 Knoll Drive, Bldg A, Ventura, CA. 93003  
(805) 642-8833  
[magnusonsuperchargers.com](http://magnusonsuperchargers.com)

# INSTALLATION MANUAL

## Magnuson SuperCharger Radix Max Intercooled Supercharger System GM Heavy Duty 6.0 Liter Engines

Please take a few moments to review this manual thoroughly before you begin work: Make a quick parts check to make certain your kit is complete (see shipper parts list in this package). If you discover shipping damage or shortage, please call our office immediately. Take a look at exactly what you are going to need in terms of tools, time, and experience. Review our limited warranty with care. When unpacking the supercharger kit DO NOT lift the supercharger assembly by the black plastic bypass actuator. This is pre-set from the factory and can be altered if used as a lifting point!

Caution: Relieve the fuel system pressure before servicing fuel system components in order to reduce the risk of fire and personal injury. After relieving the system pressure, a small amount of fuel may be released when servicing the fuel lines or connections. In order to reduce the risk of personal injury, cover the regulator and fuel line fittings with a shop towel before disconnecting. This will catch any fuel that may leak out. Place the towel in an approved container when the job is complete.

***This supercharger system requires the use of only premium gasoline fuel, 91 octane or better. It is NOT compatible with E85, Ethanol, or Flex fuels.***

Magnuson Products recommend that you run a minimum of one (1) tank of premium fuel through your vehicle prior to installation of the system to prevent any possible damage that may occur due to running the supercharged engine on lower octane fuel.

Magnuson Products Supercharger systems are designed for engines and vehicles in “GOOD” mechanical condition. Magnuson Products recommend that a basic engine system “Health Check” be performed prior to the installation of this supercharger system. Be sure to check for any pending or actual OBDII codes and fix/repair any of the stock systems/components causing these codes. If there are codes prior to the installation they will be there after the installation.

Magnuson Products also recommend the following services to be performed on your vehicle before starting and running the vehicle post supercharger system installation:

- Fuel Filter change
  - Engine oil and filter change using brand name oil (organic or synthetic) and filter
- NOTE:** It is VERY IMPORTANT to use the factory specified oil viscosity. The original equipment manufacturer has selected this grade of oil to work with your other engine systems such as hydraulic chain tensioners and variable cam controls. Deviation from this specification may cause these systems to fail or not function properly. Please refer to your owner’s manual for the recommended oil viscosity for your engine and application.
- On newer vehicles not requiring new spark plugs it is important to verify the spark plug air gap.

On older vehicles Magnuson Products recommend these additional services to be performed:

- New spark plugs with the air gap set at the factory specifications OR new specifications if required by the installation manual.
- Coolant system pressure test and flush. **NOTE: YOU MUST USE GM SPECIFIED COOLANT MIXTURE!**

Non “Magnuson Approved” calibrations or “tuning” will Void ALL warranties and CARB certification.

## **Tools Required**

- Safety glasses
- Metric wrench set
- 1/4", 3/8", and 1/2" drive metric socket set (standard and deep)
- 8mm hex (Allen) wrench
- 3/8" and 1/2" drive foot pound and inch pound torque wrenches
- Belt tensioner wrench or 1/2" breaker bar
- Hose cutters, and utility knife
- Phillips and flat head screwdrivers
- Fuel quick disconnect tools (included in kit)
- E5 Torx socket
- Small or angled 3/8" drill motor
- Large Drain pan
- Compressed air, air nozzle and 1/2" Impact Gun with 22mm and 24mm impact sockets
- Pry Bars

## **IMPORTANT**

Please remember to follow all safety rules that apply when working, including:

- Wear eye protection at all times.
- Do not work on a hot engine.
- Be careful around fuel - use shop towels to catch any spills and dispose of towels properly.

### **Contact Information:**

**Magnuson Products LLC**  
**1990 Knoll Drive, Bldg A**  
**Ventura, CA 93003**

**Sales/Technical Support Line (805) 642-8833**  
**Websites [www.magnusonsuperchargers.com](http://www.magnusonsuperchargers.com)**  
**Email [sales@magnusonproducts.com](mailto:sales@magnusonproducts.com)**

# Table of Contents

Section 1: Tuning Your Vehicle Computer and Initial Steps	5
Section 2: Remove Factory Intake Manifold and Accessories	6
Section 3: Modify Coil Packs, and Alternator Bracket Removal	14
Section 4: Crank Pinning	19
Section 5: Supercharger Preparation and Installation	21
Section 6: Hose and Wiring Connection, and Belt Installation	26
Section 7: LTR Installation	33
Section 8: Reservoir and Cooling Hose Installation	37
Section 9: Intercooler Pump Wiring and Air Inlet Installation	42
Section 10: Fluid Fill and Final Testing	48

**\* PLEASE PAY ATTENTION TO THE STEPS IN THIS INSTRUCTION MANUAL. ENGINE DAMAGE CAN OCCUR IF YOU DO NOT FOLLOW THE INSTRUCTIONS. \***

**NOTE: For the purpose of these instructions all references to left or right side are assumed to be as indicated from the seated position in the driver seat of the vehicle.**

## Section 1: Tuning Your Vehicle Computer and Initial Steps

1. If your kit came with the SCT tuner follow the provided SCT instructions for uploading the new tune to your vehicle. If your kit did not come with an SCT tuner you will have to use HP Tuners or equivalent to load your calibration.



2. Your Intercooler system is sensitive to corrosion. It's very important to use the OEM recommended coolant mixture in your supercharger system as well.



3. Your system requires the use of minimum 91 Octane gasoline fuel. This system is not compatible with E85 fuel.

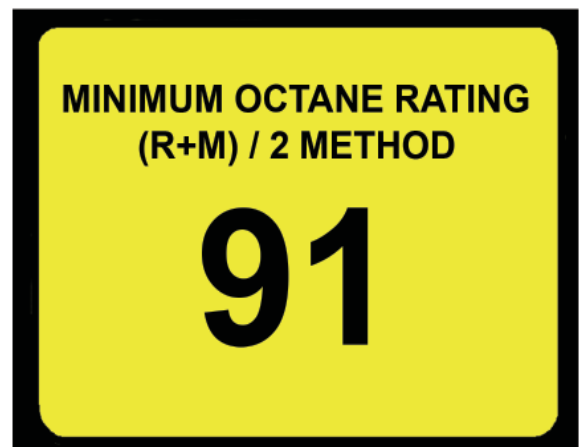

4. Disconnect the negative battery wire from the battery using a 10 mm socket wrench. Remove the negative wire from the battery terminal and cover the lead to avoid any accidental connection.



5. There may be a second battery located on the left side front of the vehicle. This battery should be disconnected, and covered as well. Ensure that the power is completely disconnected from the vehicle before continuing any further.



## Section 2: Remove Factory Intake Manifold and Accessories

6. Remove the fuel cap to relieve fuel pressure.



7. Remove the plastic engine cover by lifting up at the front and pulling the cover forward. This cover will not be re-used.



- Using an 8 mm nut driver or a flat blade screwdriver, loosen the two clamps, one at the throttle body and one at the MAF sensor (shown with arrows).



- Disconnect the loom clamp from the upper radiator hose using a small flat blade screwdriver.



- Disconnect the PCV hose from the airbox.



- Everything should now be free from the engine so the air intake assembly can be removed from vehicle, this part will not be re-used.



12. Disconnect the wire loom clamp from the arrow location.

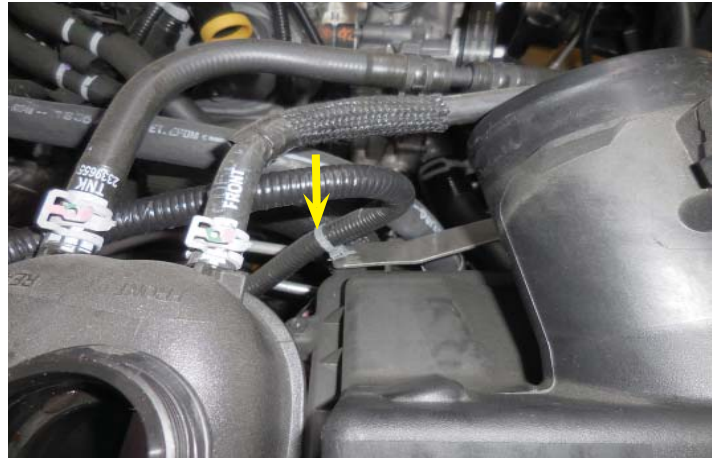

13. Unplug the electrical connector from the MAF sensor.



14. Firmly grasp the air intake box and pull up, removing it from the vehicle. The air box will be re-installed in a later step.



15. Using a 10 mm socket wrench, remove the three bolts that secure engine cover support bracket to the intake manifold. This will not be re-used.





16. Remove the wiring harness bracket from the intake manifold by removing the nut with a 10 mm socket wrench.



17. Disconnect all electrical and hose connections from the intake manifold. Start by unplugging the ETC connector from the throttle body.



18. Unplug the eight fuel injector plugs by pulling up on the gray tab and then pushing in on the release tab.

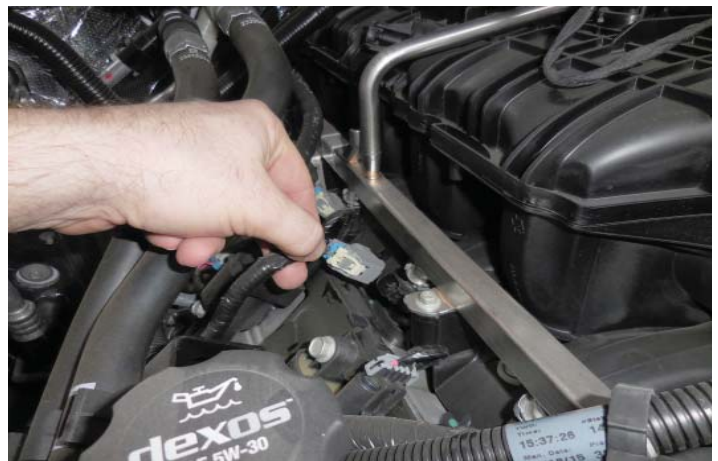

19. Disconnect the electrical plug from the MAP sensor located on top of the intake manifold at the front. Disconnect by pressing down on the release tab on top of the connector and pull free from the MAP sensor.



20. Now that all the electrical connections are free from the manifold, move the wiring harness out of the way by moving them over to the driver side of the engine compartment. Push the wires in the back behind the manifold.



21. With the wiring harness out of the way, unplug the EVAP electrical connector from the solenoid.



22. Remove the EVAP line from the solenoid by pressing in the gray retainer clip and pulling the line off of the solenoid. Repeat procedure for removing the other end of this line.



23. Disconnect the opposite side of the EVAP hose at the rear of the engine where shown with an arrow.



24. Next, remove the PCV hose from the top of the intake by following the instructions in the next step. Also, remove the other end of the hose from the rear of the valve cover. This will not be re-used.



25. To remove, first the clip connector on the valve cover needs to be released and disconnected. Then rotate the entire assembly clockwise 90° (looking down on the intake manifold) then pull up as the twist lock is released.



26. Remove the alternator to help ease removal of the manifold. Start by disconnecting the electrical connector on the top of the alternator.



27. **Ensure that batteries are disconnected before proceeding to avoid a spark that could ignite fuel vapors.** Using a 13 mm socket wrench, remove the nut holding the positive (+) wire to the top of the alternator. Route the wire over towards the right side fender, out of the way.



28. Remove the stainless steel safety clip from the fuel line. Do not discard. This will be re-installed later on.



29. Gather the provided fuel line disconnect tool. This will be used in the next step.

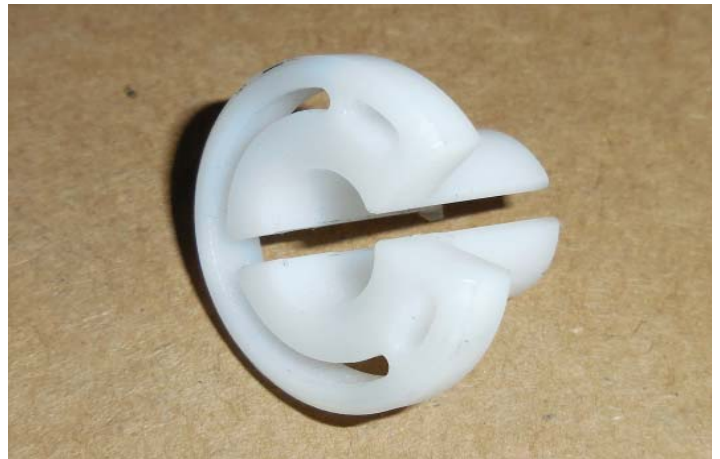

30. **CAUTION! Always wear safety glasses when working with fuel. Ensure that the negative (-) battery cable is still disconnected.** Using the fuel line disconnect tool provided, remove the fuel line from the fuel rail. Slip the tool over the male side of the connection and push together then pull apart while keeping pressure on the disconnect tool. **CAUTION! Fuel system may be under pressure. Avoid open flames or any source of ignition.**



31. Remove the stock belt using a 15mm socket wrench on the tensioner pulley (shown with an arrow). The belt will be replaced with the longer belt provided in the kit.



32. Using a 15mm socket wrench, remove the two bolts securing the alternator to the bracket and remove the alternator from the vehicle. This will be re-installed later on.



33. The intake manifold is now ready to be removed. Using an 8mm socket wrench, remove the ten bolts that secure the manifold to the engine.



34. With all of the bolts removed, lift the intake manifold up and out of the vehicle and set aside. **CAUTION! Take care not to drop any bolts, or debris into the intake ports.**



35. Using a vacuum cleaner remove any debris from the intake port area. **CAUTION! Be careful not to get any debris down the intake ports.**



36. Cover the intake ports with tape or some clean rags so that nothing can fall into ports. If you use tape you will need to clean the surface with lacquer thinner.



37. The Valley cover may have a tab on the front passenger side that needs to be ground down to avoid contact with the new intake manifold. If so, use a felt tip pen and mark a line approximately  $\frac{1}{4}$ " up from the main surface of the valley cover around this tab as shown. Using a die grinder or other suitable tool (even a file will work). Take this tab down to the line as shown in the inset photo. Make sure no debris from grinding gets into any intake ports or any other openings of the engine, vacuum debris completely to ensure no contamination remains.

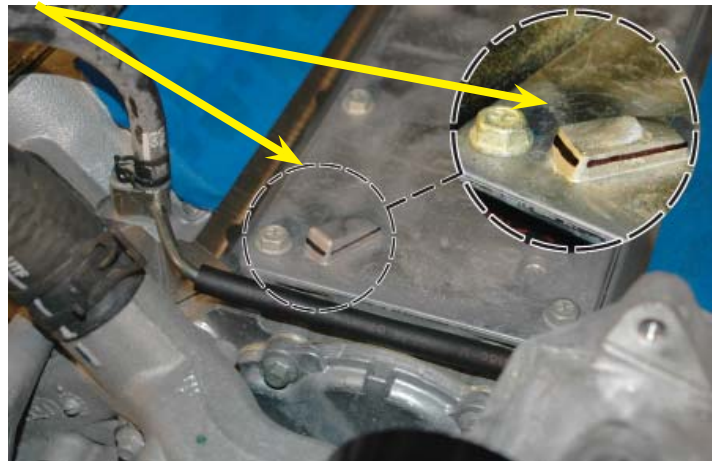

### Section 3: Modify Coil Packs, and Alternator Bracket Removal

38. On each side of the engine disconnect the main coil bracket plug. You must release the security tab prior to unplugging.
39. Remove wire harness clips from both sides of the engine. You can see one of these clips at the arrow location.



40. Disconnect all eight plug wires from the coil packs.

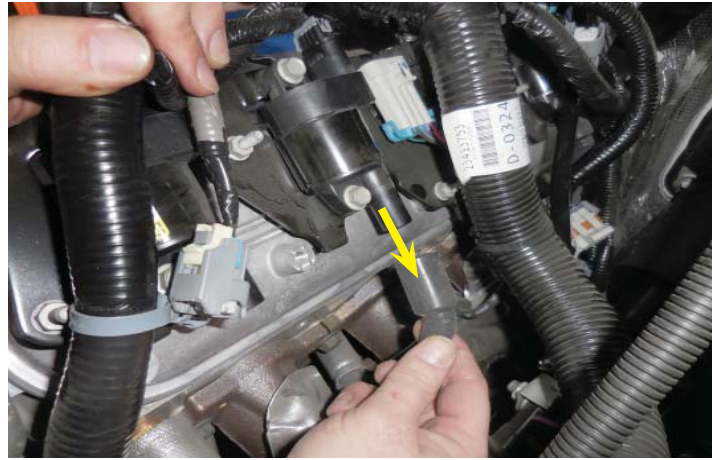

41. Use a 10mm wrench to remove the bolts holding the coil packs to the valve covers. There are 5 of these bolts on each coil pack set.



42. Also remove the following bracket. It will be replaced after the coil packs have been modified.



43. The coil packs will need to be modified to accommodate the new supercharger system. Use a small screwdriver to un-clip the top and bottom halves of the plastic wire covers. Remove these covers from the coil packs completely. You may need to remove one coil pack from the bracket to allow removal of the plastic cover.



44. Remount the coil packs to the valve cover using a 10mm wrench. Torque these bolts to 106 in-lbs.



45. Plug the coil pack electrical connector back in. Ensure that you have the security tab (shown with the arrow) installed as well.

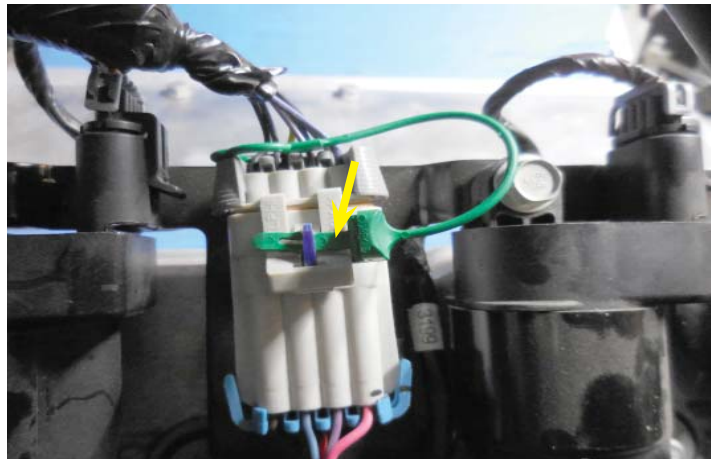

46. Replace the bracket that was removed earlier.



47. Replace the plug wires on the coil packs on both sides of the engine.





48. Remove the clip holding the upper radiator hose above the fan shroud.



49. Hold the water pump pulley with a strap wrench while you remove the fan blade. Use a 36mm open end wrench or large adjustable crescent wrench.



50. Here is a photo with the fan removed.



51. Disconnect the line from the clip shown with the arrow.



52. Disconnect the oil cooler hard lines from the clip shown with the arrow.



53. Remove the bolts holding the upper radiator mount where shown with the arrow. Repeat this process on the other side of the radiator.



54. Remove the rivets shown with the arrows that hold the upper and lower halves of the fan shroud. There are two more on the other side of the radiator. Pull up on the center section to disengage the rivet, then remove from shroud assembly.

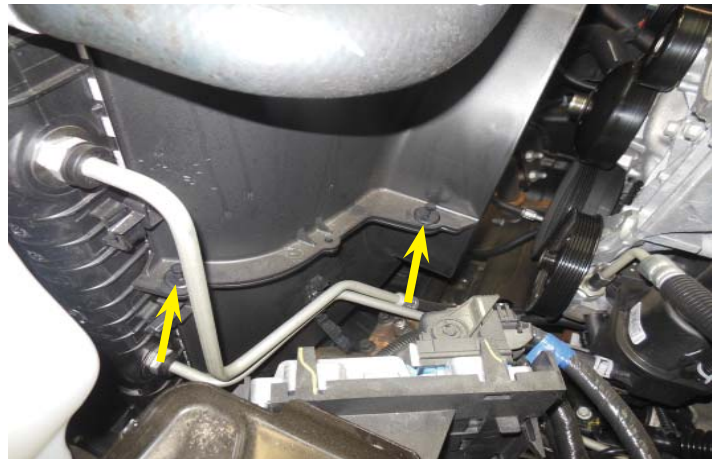

55. Remove the upper half of the fan shroud.



56. Disconnect the hard line at the clip location shown with the arrow.



57. Remove the lower half of the fan shroud.



#### Section 4: Crank Pinning

58. Use a 24 mm socket and impact wrench to remove the main crank pulley mounting bolt. You may need to apply some heat to the bolt to aid in removal.



59. This is the pin drill guide and provided mounting bolt. The stepped side faces towards the crank to center with the pulley.



60. Replace the removed crank pulley mounting bolt with the provided drill guide and mounting bolt. It's easier if you have the holes of the drill guide oriented horizontally for visibility purposes. Torque this down to at least 24 ft-lbs.



61. Place a strip of visible tape around the top of the last step of the provided step-drill for visual reference. Use a drill motor to drill out the crank and pulley completely to the second step of the provided step drill. You can easily see when you have gone far enough when the tape touches the face of the key way guide.



62. Use compressed air to evacuate the particles from the new holes. Vacuum out area to clear metal chips.

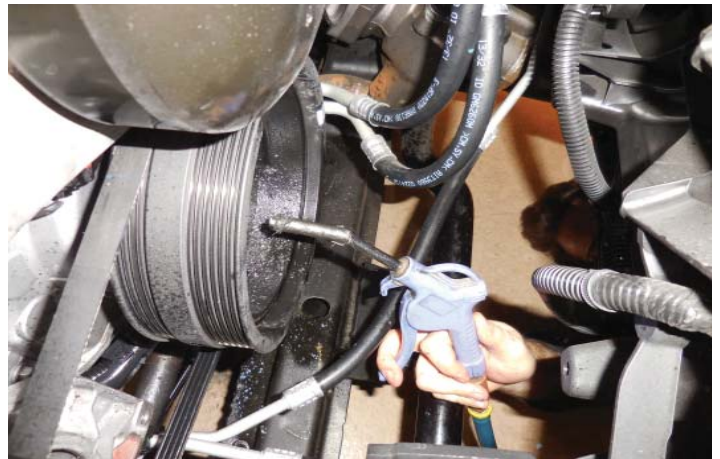

63. Install the reamer bit in your drill motor and ream out your holes. Once again use compressed air to remove debris from the two holes. Now remove the drill key way guide and mounting bolt using a 22 mm socket.



64. Place two provided pins into the holes. Use a drift pin, or nail set to ensure that the two pins get completely into the holes.



65. This picture shows that the pins are behind the surface where the pulley bolt will touch. **Make sure the pins are below the contact surface for the harmonic balancer bolt.** Apply RTV to cover the pins once they are installed.



66. Install the new provided factory GM harmonic balancer bolt. Using a 24 mm socket, tighten the new harmonic balancer bolt according to the GM specifications.

- a. Tighten to 50 N-m (37 ft-lbs) using a torque wrench. Verify your torque wrench settings
- b. Tighten an additional 140° using a torque angle meter.

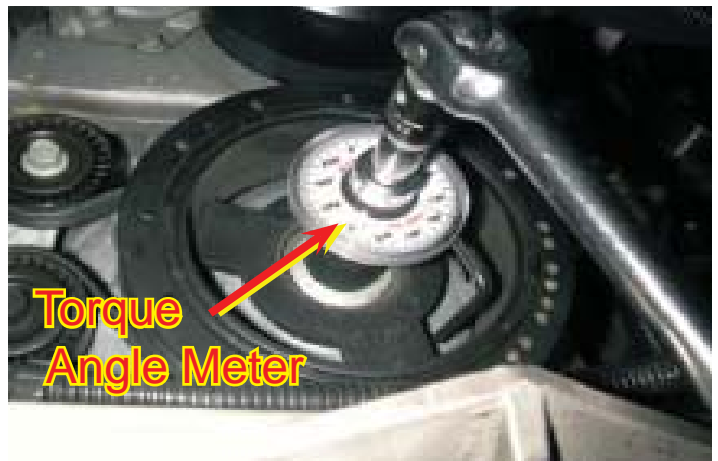

## Section 5: Supercharger Preparation and Installation

67. Disconnect the short EVAP pipe from the EVAP Solenoid on the stock intake manifold.

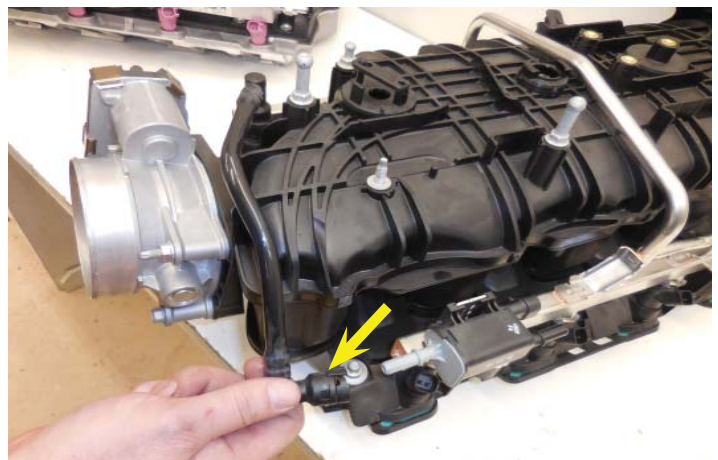

68. Use a flat blade screwdriver to press the release tab on the back side of the EVAP solenoid (shown with an arrow). Remove the OEM EVAP solenoid from the stock manifold by lifting up to free the unit from the mounting bracket. This will be reused.



69. Apply Lubriplate grease to the provided fuel manifold O-ring.



70. Install the provided O-ring in the arrow location.



71. Install the provided fuel manifold in the location shown. Torque the two fuel manifold bolts to 106 in-lbs using a 10mm socket and torque wrench. Verify your torque wrench settings.

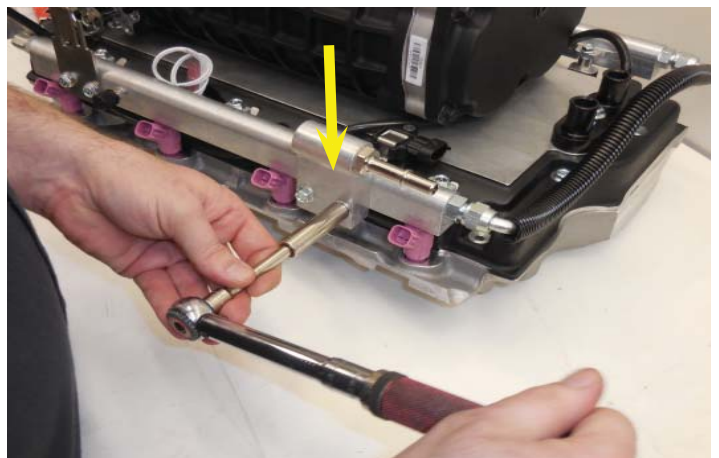

72. Remove the OEM (Original Equipment Manufacturer) intake manifold gaskets from the OEM intake manifold. Inspect the gaskets for damage and replace if necessary.

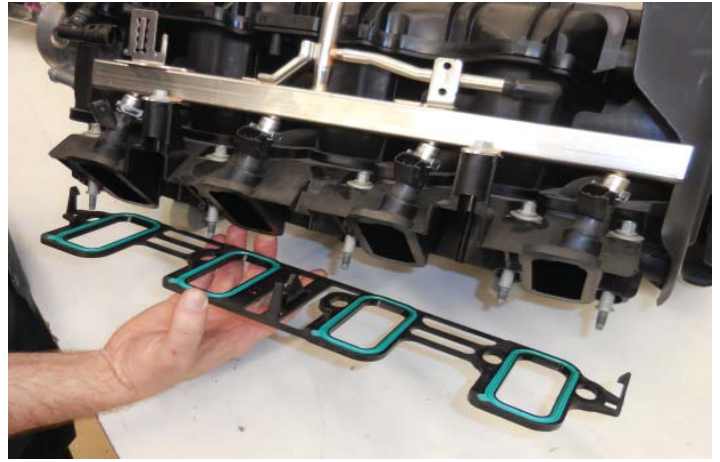

73. Now install the OEM gaskets onto the new supercharger manifold.

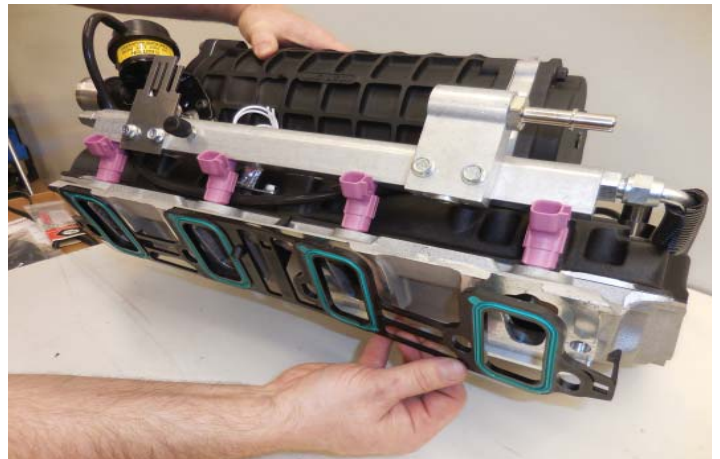

74. Using a 10 mm socket wrench, remove the throttle body from the OEM intake manifold.



75. Next, using an E5 Torx socket, remove the two mounting studs from the stock manifold. Also remove the stock throttle body O-ring from the OEM manifold. Clean off any oil, and inspect the O-ring before installing it onto the supercharger inlet.

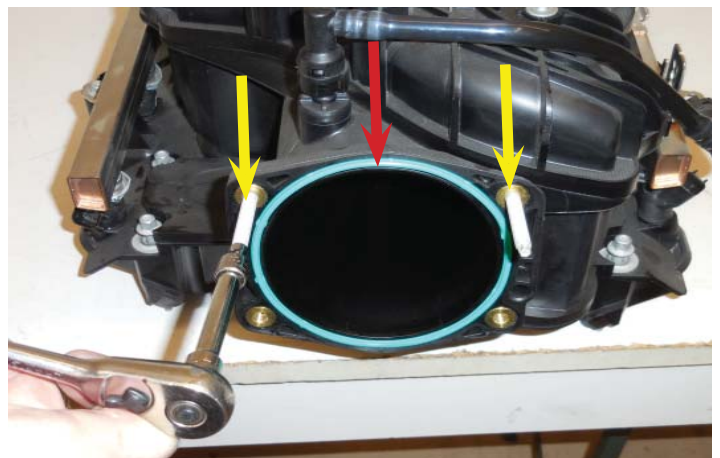

76. Install the two studs from the previous step into the supercharger inlet flange using a E5 Torx socket. Then press the throttle body O-ring into the inlet as shown.

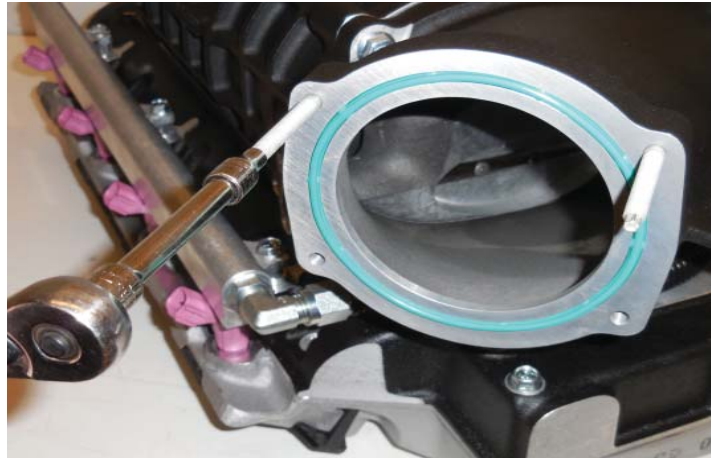

77. Now install the throttle body using the OEM hardware and torque to 106 in-lbs with a 10 mm socket wrench. Verify your torque wrench settings.



78. Remove the bracket shown with the red arrow. After unbolting the bracket you will have to pry the bracket free from the roll pin holding it to the head.

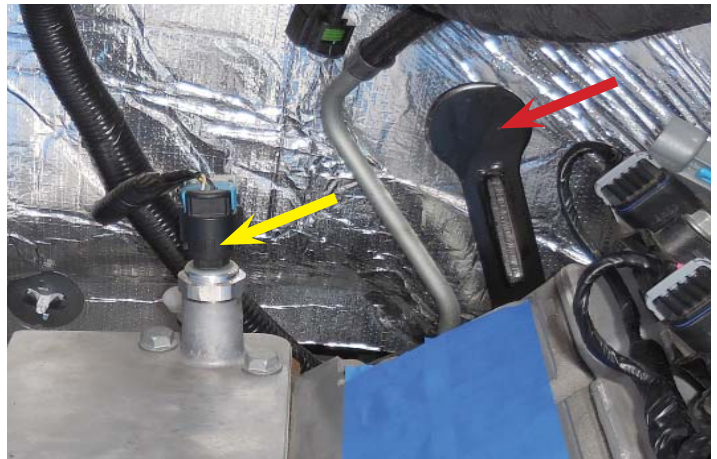

Follow the next few steps for proper orientation of the oil pressure sensor shown with the yellow arrow before you install the supercharger.

79. The secondary locking clip on your oil pressure sensor connector may cause interference with the supercharger assembly. If you have previously removed the sensor, you should wrap the sensors threads with Teflon tape or paste before reinstalling. Refer to the next step for further positioning information.

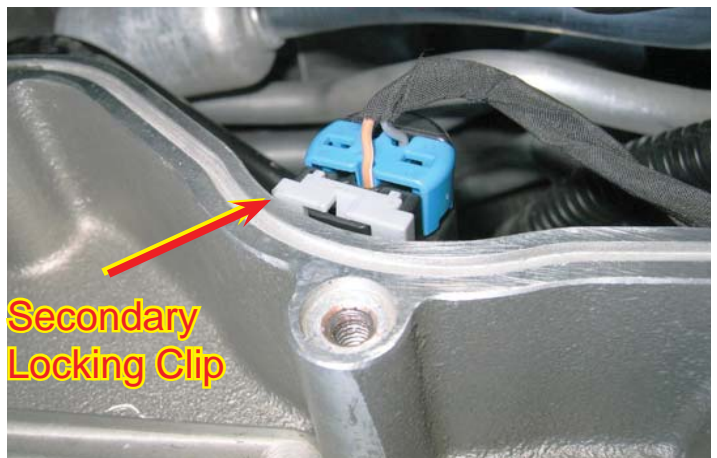



80. This illustration shows the top view of the oil pressure sensor installed on the engine. If the secondary locking clip is not in position #1, you will need to re-clock it (rotate). If the secondary locking clip lands in position #2, you may increase the installation torque to rotate into position #1. You should not have to exceed 24 ft-lbs.

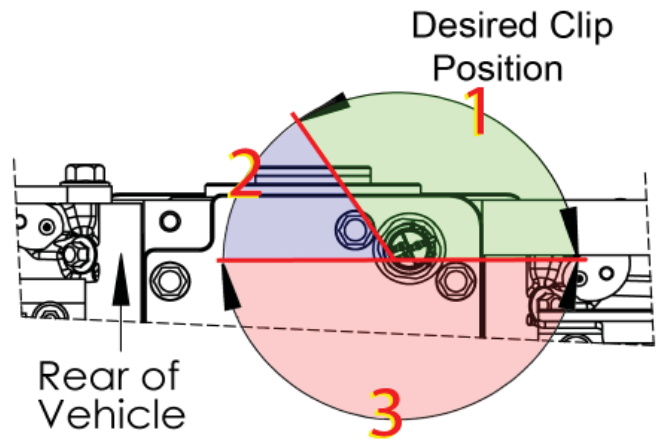

81. If the secondary locking clip lands in position #3, you will need to remove the sensor and re-clock it using the supplied copper shim. Before reinstalling, wrap the sensor's threads with Teflon tape or Teflon paste. Reinstall the sensor and shim into position #1 by torquing to 15 ft-lbs minimum to 24 ft-lbs maximum.



82. Remove the tape from the intake ports. Remove any loose parts, or tools from the manifold valley. Spray silicone or some mild soap and water solution on cylinder head surface to lubricate. This makes the intake manifold slide around a little to help line up the holes. **(Do not use anything that will damage the intake gaskets such as petroleum based products, etc.)**



83. With the help of an assistant or two, carefully lower manifold assembly into place. **Use care to not damage gaskets.**



84. Ensure that the supercharger is sitting flat on the intake surfaces, and that no obstructions are present.



85. Torque all ten of the supercharger head bolts gradually and evenly to a torque of 106 in-lbs following the numerical order given on the torque diagram at the back of this manual.



86. Plug in the eight fuel injection wire connections.



## Section 6: Hose and Wiring Connection, and Belt Installation

87. Push the fuel line connector on to the fuel manifold. Ensure that the fuel line is pushed all the way on. **Pull on the connector to check that it is secure, you should not be able to remove the connector unless you use the removal tool. Inspect factory fuel line for kinks or tight bends in braided section. If required push gently on fuel line near firewall to eliminate kinks/tight bends.** Replace the stainless steel safety clip that was removed.



88. Remove the bracket shown with the arrow. You will have to clip the cable tie shown, and trim back the electrical tape to remove the bracket. Replace any electrical tape necessary to cover the split loom after the bracket is removed.



89. Open the clamp shown to allow the throttle control connection enough slack to connect to the throttle body.



90. Plug the throttle control connection into the throttle body.



91. Plug in the MAP sensor connection.



92. Install the OEM EVAP solenoid to the mounting bracket at the left front fuel rail.



93. Bend the tab shown with the arrow slightly towards the EVAP solenoid to retain the solenoid.

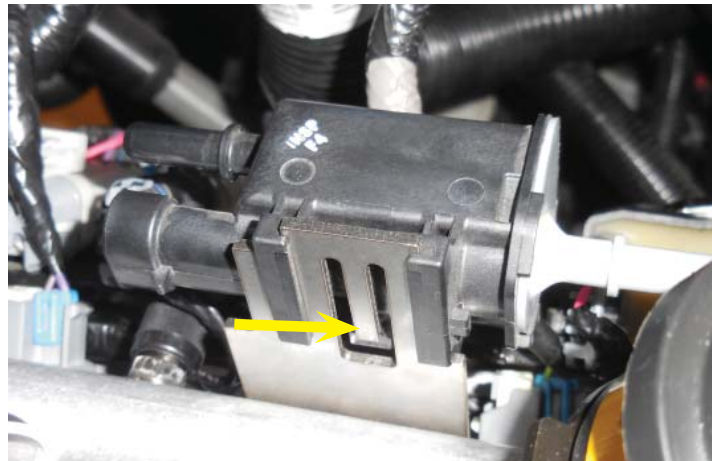

94. Connect the OEM EVAP hose to the original location at the back of the left valve cover.



95. Connect the OEM EVAP hose to the EVAP solenoid, and plug in the electrical connection.

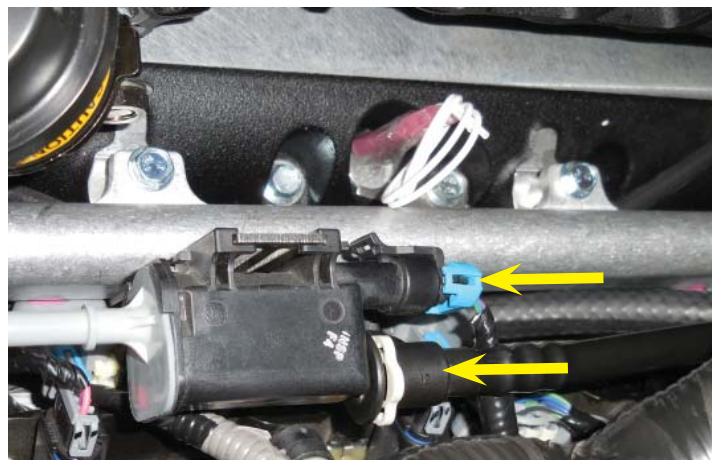

96. Remove the rubber cap from the rear 90° barb shown with the red arrow, and place it on the barb shown with the yellow arrow.



97. Route the provided 3/8" hose with mesh sleeve along the left fuel rail and under the wire harness with the straight connector towards the rear of the valve cover.



98. Connect the straight quick connector to the PCV barb at the left side rear of the engine.



99. Connect the other side of the hose from the last step to the rear 90° hose barb and install a spring clamp. Secure the hose at the location shown with the arrow using a provided cable tie. Trim the end of the cable tie off. **Do not overtighten and crush the hose.**



100. Secure the hose from the last step with another cable tie at the location shown with the arrow. **Again do not crush the hose.**



101. Connect the provided hose with the 90° quick connect fitting to the EVAP solenoid. Connect the opposite end of this hose to the front 90° hose barb using a provided spring clamp. Route the hose as shown in the picture.

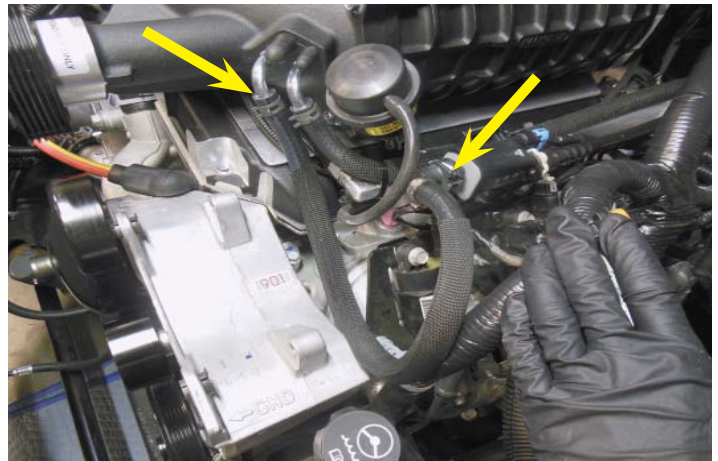

102. Use four supplied cable ties to secure the electrical lines shown.



103. Reinstall the alternator in its original position. Ensure the EVAP hose behind the alternator does not get crushed. Replace the OEM bolt in the arrow location shown with the provided button head bolt. Torque both bolts to 35 ft-lbs.



104. Connect the battery positive cable to the alternator with a 13 mm socket wrench.



105. Remove the OEM bolt shown with the arrow.



106. Gather the following provided parts. Apply Loctite 242 to the threads on the bolt.



107. Slide the bolt through the pulley on the side without the snap ring as shown and slide the spacer with the smaller side inserted into the bearing where shown with the arrow.



108. Install the idler assembly from the last step in the location where the OEM bolt was removed earlier and torque to 35 ft-lbs. Remove the OEM idler shown with the red arrow.

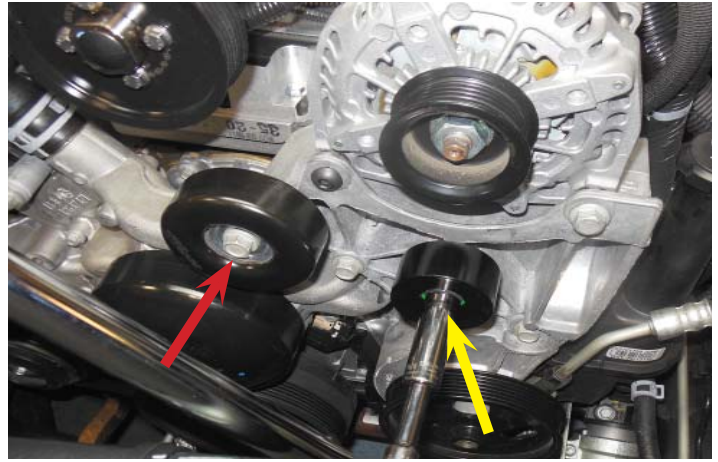

109. Gather the following provided parts.



110. Assemble the provided parts in the order shown in the photo with the smaller stepped end of the spacer into the bearing. Apply Loctite 242 to the threads on the bolt.



111. Install the provided idler pulley assembly from the last step in the location indicated with the arrow. Torque to 35 ft-lbs.

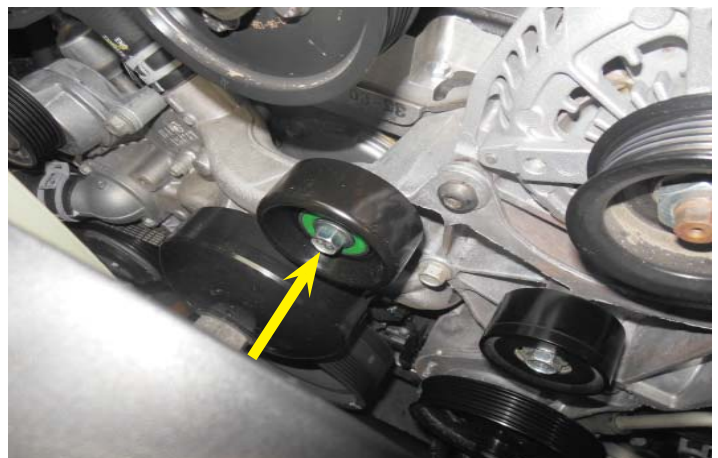



112. Install the provided belt as shown in this photo. Refer to the diagram at the back of the manual for a better view of the routing.



## Section 7: LTR Installation

113. Remove 12 push pin rivets from the top of the radiator cover by prying up on the center pin to release the spreaders, then pry up on the outer ring and pull the push pins free.



114. Remove the cover and set aside for later reinstall.



115. Remove 6 bolts holding the top of the fascia/grille to the sub frame using a 10mm wrench.



116. Pull the grill forward. The grill connections are shown here with the yellow arrows. The red arrow locations show the two holes where panel nuts will be installed in the next step.

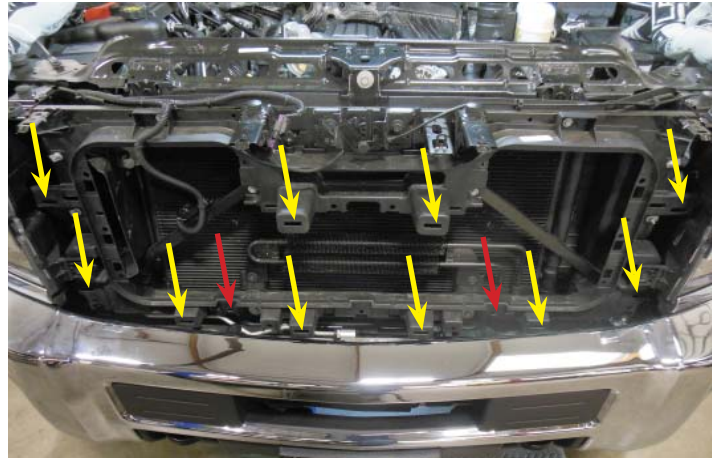

117. Install the provided clip-on nuts in the two locations shown in the last step with the red arrows.



118. Install the provided Low Temperature Radiator (LTR) mounts in the locations where the panel nuts were installed in the last step using the provided M6x16mm bolts.



119. Here you can see the final locations of the LTR mounts.



120. Install the provided sheet metal edge beading to the location highlighted in green.

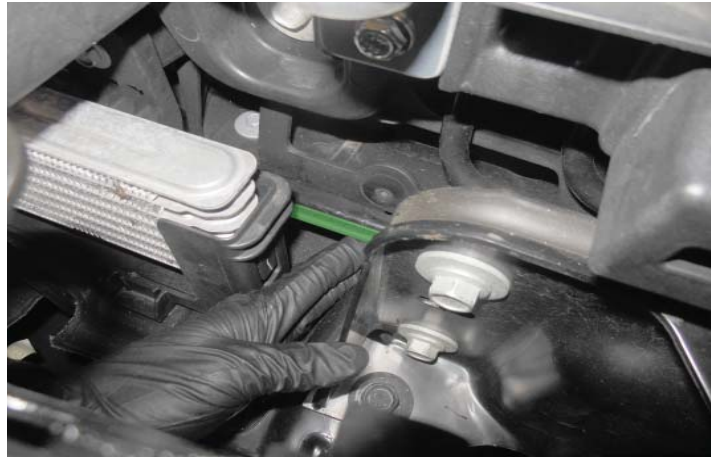

121. Make a mark at the intersection created by the two yellow dashed lines shown. One line is centered about the vertical radius of the plastic shroud. The other dashed line is located at the step in the plastic indicated with the red arrow.

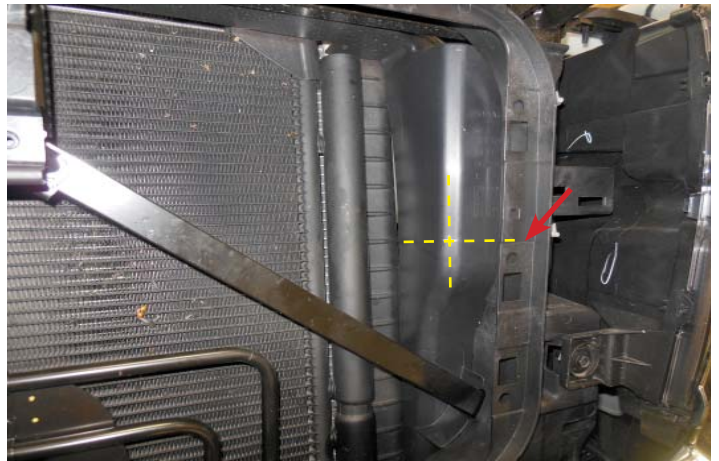

122. Drill a hole at the location marked in the last step at approximately 135° from the side of the shroud with a 1.25" hole saw.



123. Here is the completed hole made in the last step. Debur and clean the edges of the hole.



124. Remove the red caps from the provided LTR by twisting them off. **Do not cut them off as you might damage the sealing surface.**

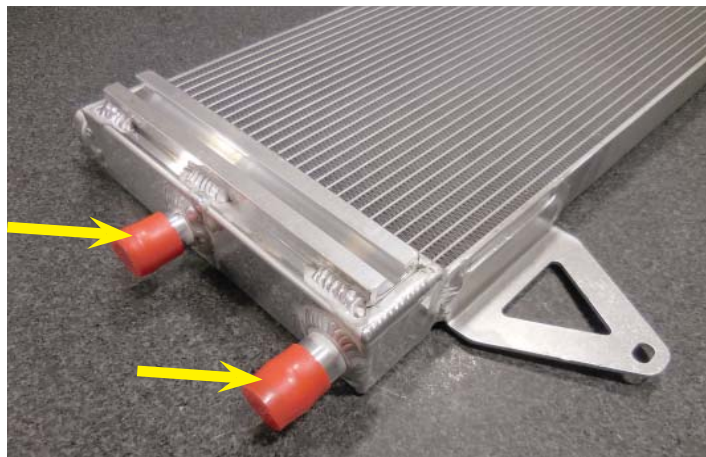

125. Slide the upper mounting point for the LTR between the two parts shown.



126. Insert the pegs into the rubber grommets on the mounts that you installed earlier.



127. Insert provided bolts on both sides of the LTR and torque bolts to 80 in-lbs.



## Section 8: Reservoir and Cooling Hose Installation

128. Attach the supplied reservoir mounting bracket to the reservoir with the provided bolts and secure using a 10mm wrench.



129. Remove the two nuts holding the master cylinder to the brake booster canister using a 15 mm socket. You may need to hold the backside of the bolt with a 1/2" wrench when loosening the nuts.



130. Replace the nuts incorporating the reservoir assembly. Torque to 25 ft-lbs. Verify your torque wrench settings. Again you may need to use a wrench to hold the bolt on the backside to prevent it from spinning.



131. Use a 12 mm socket to mount the intercooler pump to the supplied bracket as shown. The discharge barb of the pump should be perpendicular to the bracket mount. The base of the pump should be flush with the bottom Adel clamp.



132. Engage the slot of the pump bracket on the loosened bolt of the bumper support bracket on the frame rail. Replace the removed bolt incorporating the remaining hole of the intercooler pump mounting bracket. The pump discharge barb should be above the frame rail pointing to the right hand side of the vehicle. Secure the bolts using a 15 mm wrench. Torque to 35 ft-lbs.

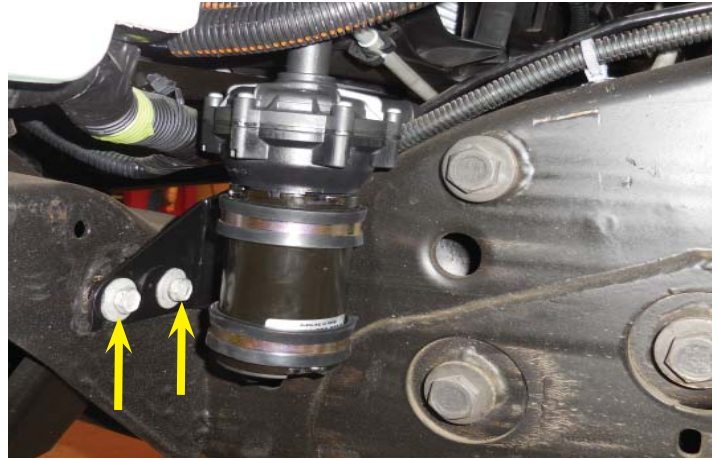

133. Refer to the expanded diagram at the end of the instruction manual to prepare your intercooler system plumbing hoses for install. When measuring the mesh sleeve make sure it is in a relaxed state.

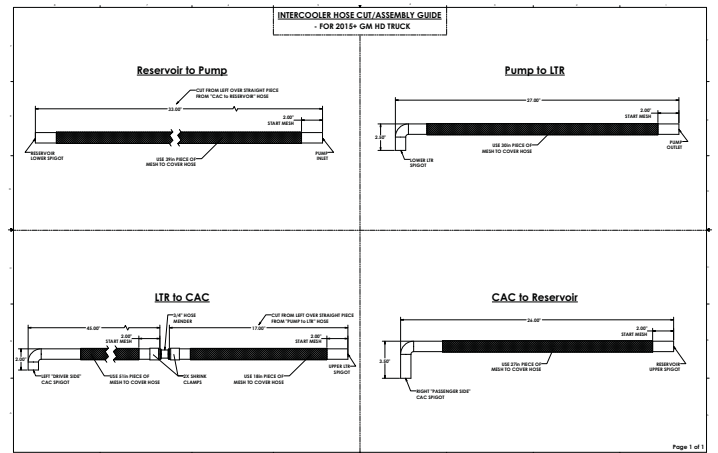

134. Here are the completed hose assemblies from the last step.



135. Slide the "Pump to LTR" hose with the long straight section through the opening shown. Make sure when sliding the hose through that the edge beading does not fall off (installed in an earlier step).



136. Connect the 90° elbow of the “Pump to LTR” hose to the lower barb on the LTR and secure with a supplied spring clamp.

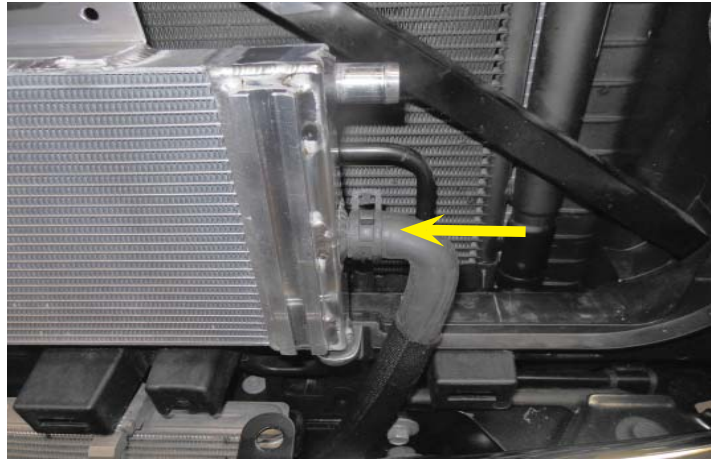

137. Install the opposite end of the “Pump to LTR” hose on the pump discharge hose barb and secure with a supplied spring clamp. Make sure the hose is free of any kinks and is not resting on any sharp edges.

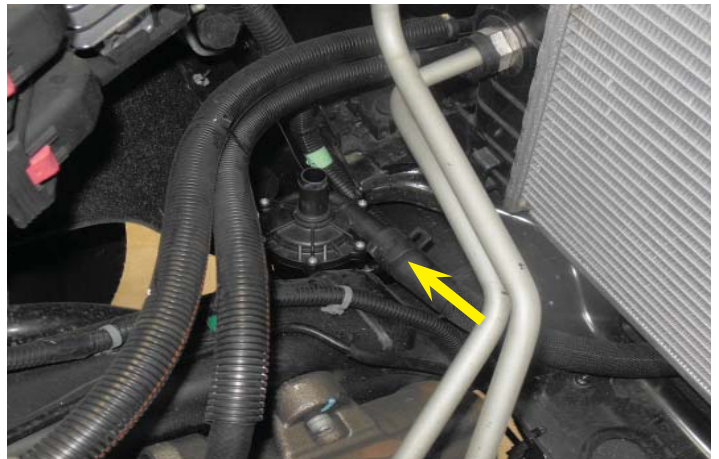

138. Connect the “Reservoir to Pump” hose on the input side of the intercooler pump and secure with a supplied spring clamp. Make sure the hose is free of any kinks, and is not resting on any sharp edges.

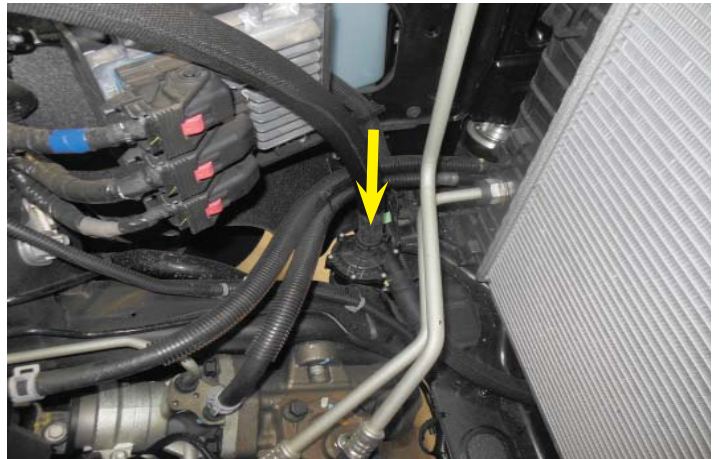

139. Connect the opposite end of the “Reservoir to Pump” line to the output side of the reservoir and secure with a provided worm gear clamp. **A worm gear clamp must be used at this location.**



140. Connect the 90° end of the “CAC to Reservoir” to the right charge air cooler outlet at the back of the supercharger using a provided spring clamp, and the opposite end of this hose to the back of the reservoir using a worm gear clamp. You must use a worm gear clamp at the reservoir. The hose has been highlighted in green for clarity.



141. Install the “CAC to LTR” hose to the left rear charge air cooler inlet on the supercharger manifold. Secure in place with a provided spring clamp.



142. Install the provided swivel mount and large cable tie (highlighted in red) to the electrical harness shown. Route the hose from the last step as shown (highlighted in green). Leave the hose free for now.



143. Continue routing the “CAC to LTR” hose (highlighted in green) along the left side of the radiator and secure it with the provided c-clip cable tie (highlighted in red) to the oil line shown.

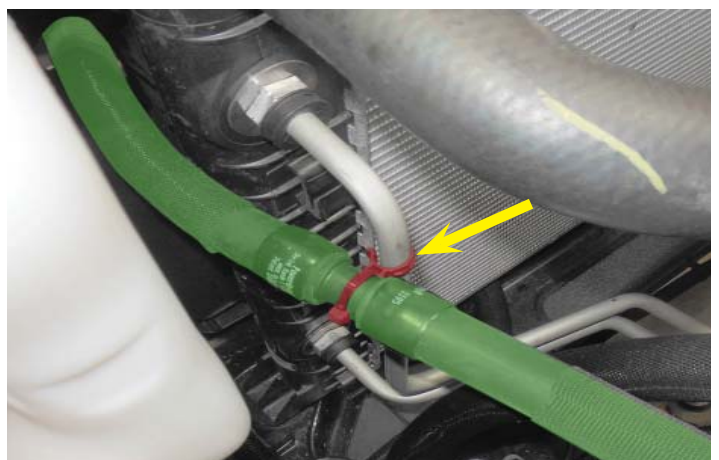



144. Return back to the swivel mount that was installed two steps ago and secure the "CAC to LTR" hose (highlighted in green) with another cable tie (highlighted in red) through the loop in the swivel mount. Trim the excess cable tie. **Do not overtighten and crush the hose.**

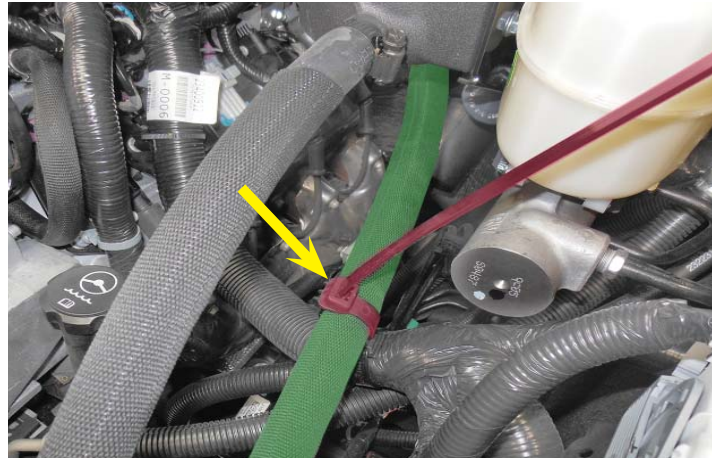

145. Insert the "CAC to LTR" hose through the hole that was cut in the plastic shroud and connect it to the top barb of the LTR. Secure the hose in place with a provided spring clamp.

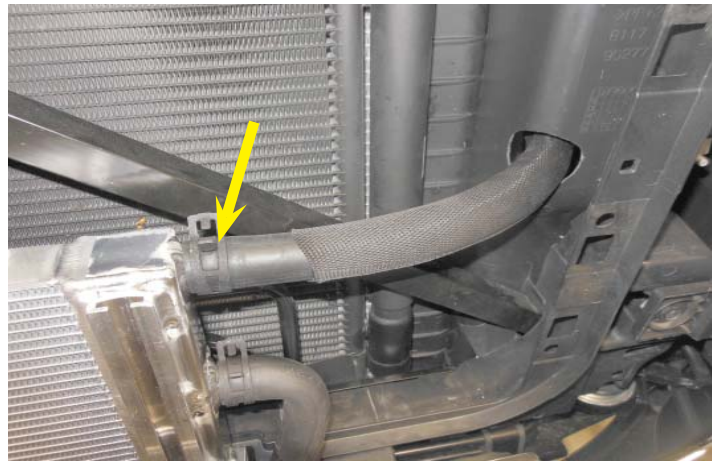

146. Install the cable tie with the barbed mount (highlighted in red) loosely around the hose near the 1.25" hole. Mark the location needed to mount the barb, and drill a 1/4" hole. Trim the excess cable tie. The cable tie should hold the hose centered about the hole so that it does not rub the edges.

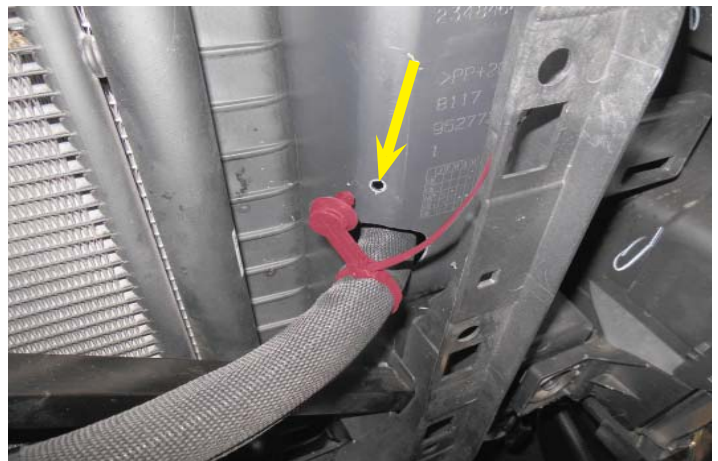

147. Install the barb into the 1/4" hole. Again the barbed mount is highlighted in red.

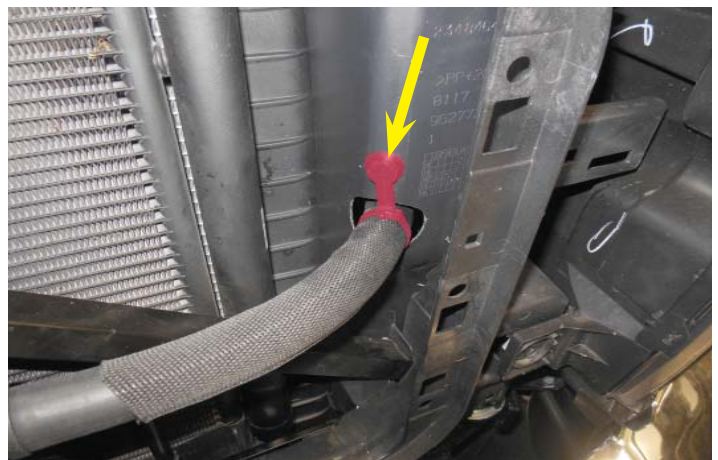

## Section 9: Intercooler Pump Wiring and Air Inlet Installation

148. Install the provided fuse in the intercooler pump wiring harness fuse holder, and replace the cap.



149. To install your intercooler pump harness bracket, begin by removing the two nuts with a 13 mm socket where the left hand (driver side) inner fender meets the firewall. This will be behind the fuse center, below the hood hinge. Place the supplied pump harness bracket onto the studs and use the factory nuts to secure in place.



150. Place the relay on the stud closest to the firewall and secure with a supplied M6 nut, using a 10 mm socket. Use the remaining supplied M6 nut to secure the fuse holder to the bracket. Make sure to route the wires to the fuse holder as shown, so that they do not rub on the sheet metal below. You may need to drill the plastic fuse holder mounting hole out for the bolt to fit.

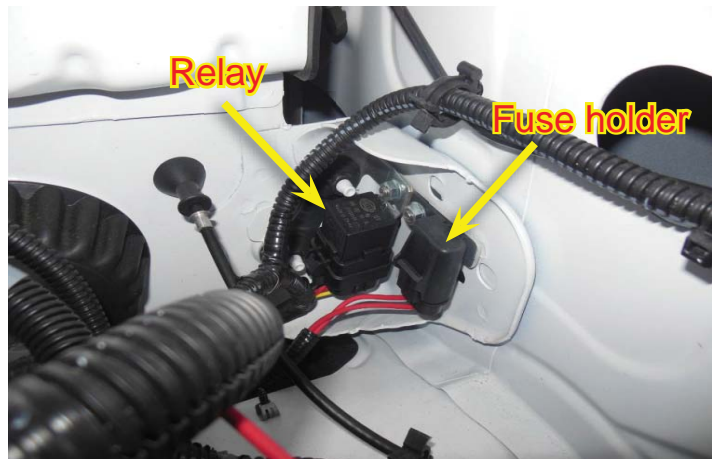

151. This view is shown from the left side wheel area with the splash guard removed for clarity. Route the plug from the wiring harness down to the inside of the fuse center, along the existing wiring harness and plug into the intercooler pump connector where shown with yellow arrow. The wire routing is highlighted in green. Secure harness with cable tie in location shown with blue arrow.



152. This view is in the left side of the engine compartment near the ECM. The intercooler pump is in the lower right corner of the photo. The wiring harness for the pump is shown highlighted in green, and the cable tie locations are highlighted in red and shown with yellow arrows.

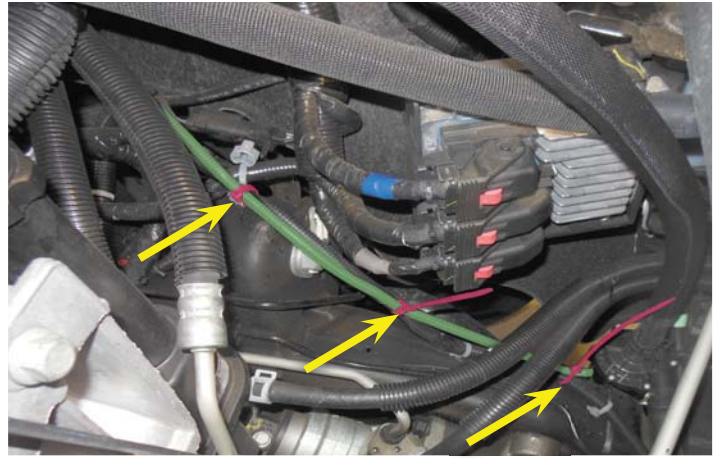

153. Secure the pump harness (highlighted in green) to the existing harness using the provided cable ties.

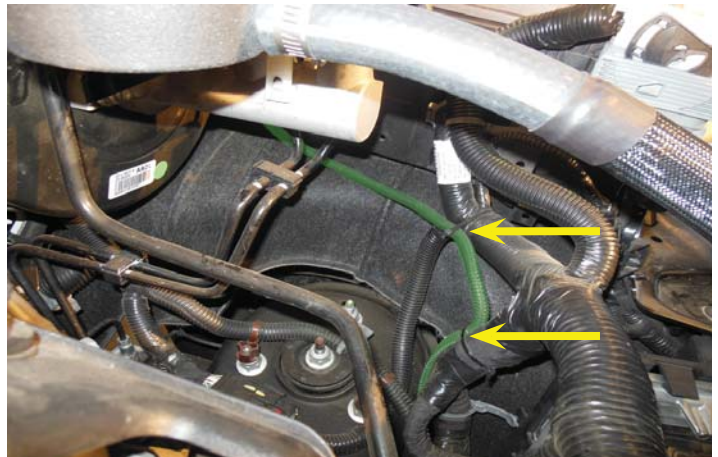

154. Remove the fuse center cover by pressing the release tabs and lifting up.



155. Cut a small slot in the back lip of the fuse center tray where shown with blue arrow. This will allow the yellow wire from the relay to pass into the fuse box.



156. Remove the fuse number 34 (labeled: ECM IGN) from the slot in the fuse center. Connect the fuse tap end of the yellow wire from the intercooler wiring harness to one leg of the fuse just removed.

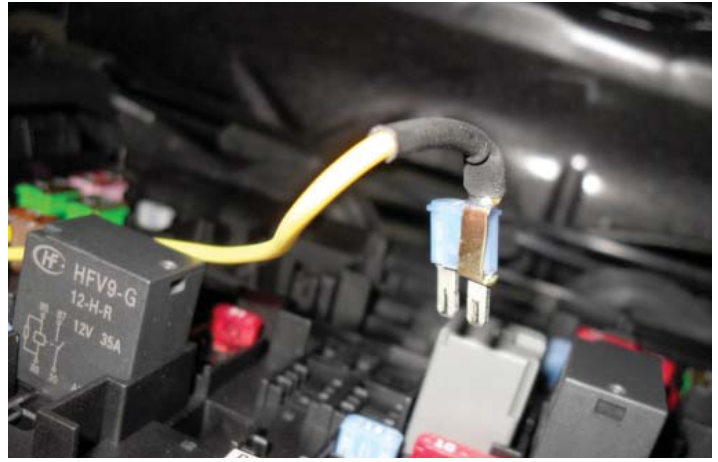

157. Replace the fuse in slot number 34 (labeled: ECM IGN) with the fuse tap installed on one leg. Press the yellow wire down into the slot you created earlier (shown with the blue arrow).

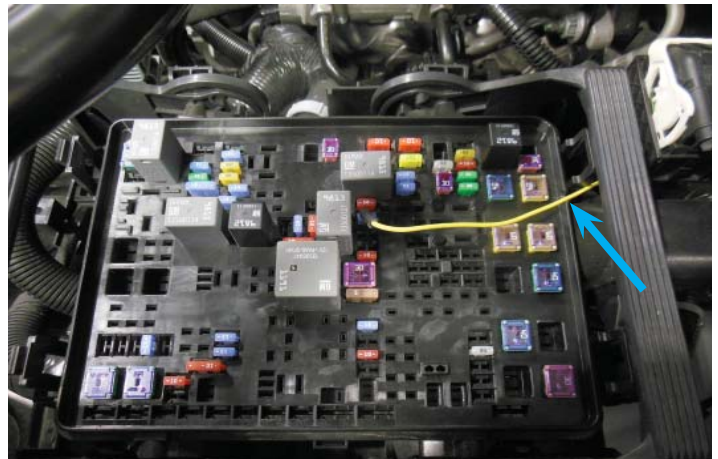

158. Replace the cover on the fuse center engaging the snaps. **The lid should NOT crush the yellow wire.**



159. Flip the cover open at the back of the fuse center. Remove the nut of the positive lead using a 13 mm wrench. Replace the nut incorporating the "eye" terminal on the red wire from the intercooler wiring harness.



160. Connect the black ground wire “eye” terminal to the existing grounding bolt at the firewall on the left hand side, just above and inside the brake booster canister.



161. Using an 8 mm socket, remove the four screws that attach the air box lid to the lower half of the air box.



162. Remove the stock air filter from the air box. Take the new K&N air filter supplied in the kit, and install it into the air box. Re-install the air box lid and then install the air box assembly back into the vehicle.



163. Install the provided MAF “Breakout Harness” at the airbox location shown with an arrow. Route the wire highlighted in green as shown and secure with cable ties in the red arrow locations.

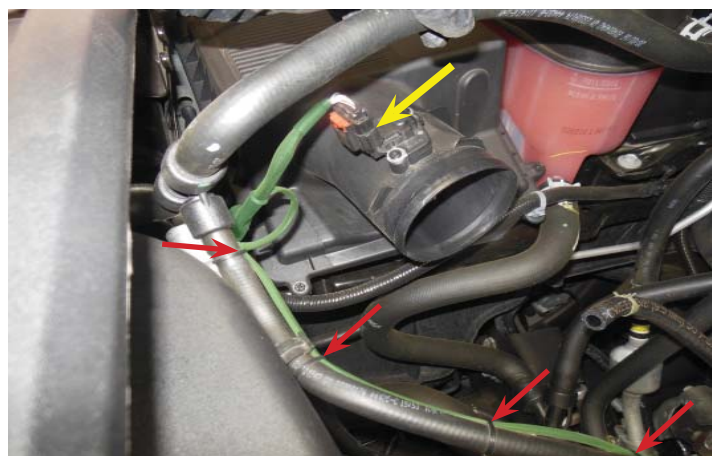

164. Continue to route the wire from the airbox as shown by the green highlighted wire harness. Secure with cable ties in the locations shown with red arrows.

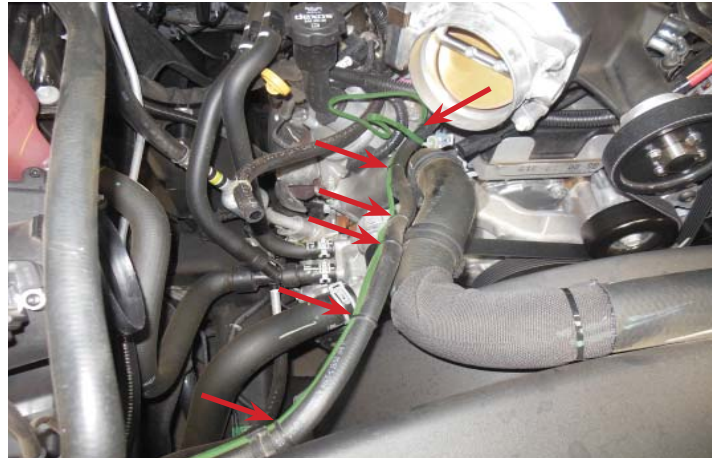

165. Route the IAT connect from the supercharger lid forward and under the inlet drive as shown. Plug in the IAT connection where shown with the arrow.



166. Gather the wire slack and secure in place with cable ties at the arrow locations. Make sure the harness coming from the supercharger lid is away from the bypass armature. Secure with cable ties if necessary.

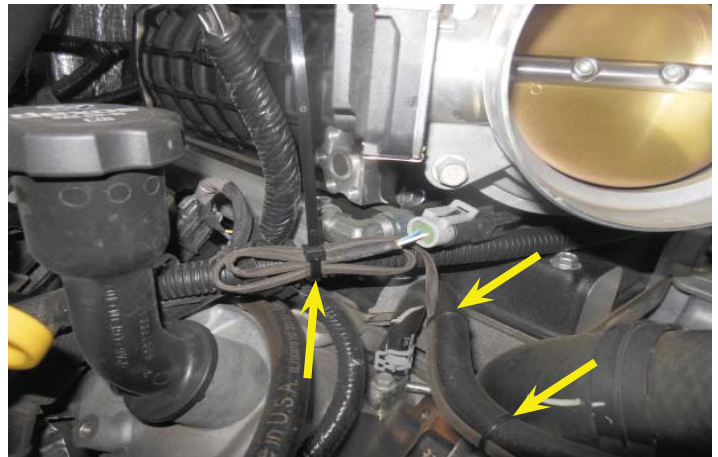

167. Connect the provided 3/8" x 18" hose (highlighted in green) to the hose barb on the right valve cover near the oil filler and secure with a provided hose clamp.



168. Gather the air tube components shown. The center aluminum air inlet color may not be silver as shown in this photo.



169. Connect one of the flexible inlets to the throttle body and secure it with a provided hose clamp.



170. Connect the middle tube and second flexible inlet onto the first flexible inlet and the air box using three more hose clamps. Ensure that the hose barb is facing towards the back as shown with the arrow.



171. Attach the opposite side of the 3/8" hose that was connected to the hose barb on the valve cover to the hose barb on the middle tube barb shown and secure with a provided spring clamp. If necessary, trim to fit without any kinks.



172. Reconnect the batteries.



## Section 10: Fluid Fill and Final Testing

173. Fill the intercooler reservoir with the vehicle manufacturer recommended coolant mixture. Have an assistant temporarily key vehicle on accessory mode to turn the intercooler pump on. Key vehicle off after 5 seconds. Fill reservoir full again and continue this process until fluid is circulating. At this time check engine and intercooling system for any leaks.



174. **Make sure that you have followed step #1 in this manual to load the proper supercharger calibration to your vehicle's ECM.**



175. Start the vehicle for 5 seconds and shut off. Check for fuel leaks and supercharger belt alignment. Check the intercooler reservoir level. Now start your engine and let it run for a few minutes to let it get to operating conditions. Let the engine cool down, and check all your levels again. After you have filled your intercooler system, and verified the connections are leak free, reinstall grill and front cover following steps shown in Section 7 in reverse order.





176. Test drive vehicle for the first few miles under normal driving conditions. Listen for any noises, vibrations, engine misfire or anything that does not seem normal. The supercharger does have a slight whining noise under boost conditions, which is normal. Check the intercooler reservoir and top off as needed.



177. After the initial test drive gradually work the vehicle to wide open throttle runs, listen for any engine detonation (pinging). If engine detonation is present let up on the throttle immediately. Most detonation causes are low octane gasoline still in the tank.

If you have questions about your vehicles performance, please check with your installation facility.

# Diagrams

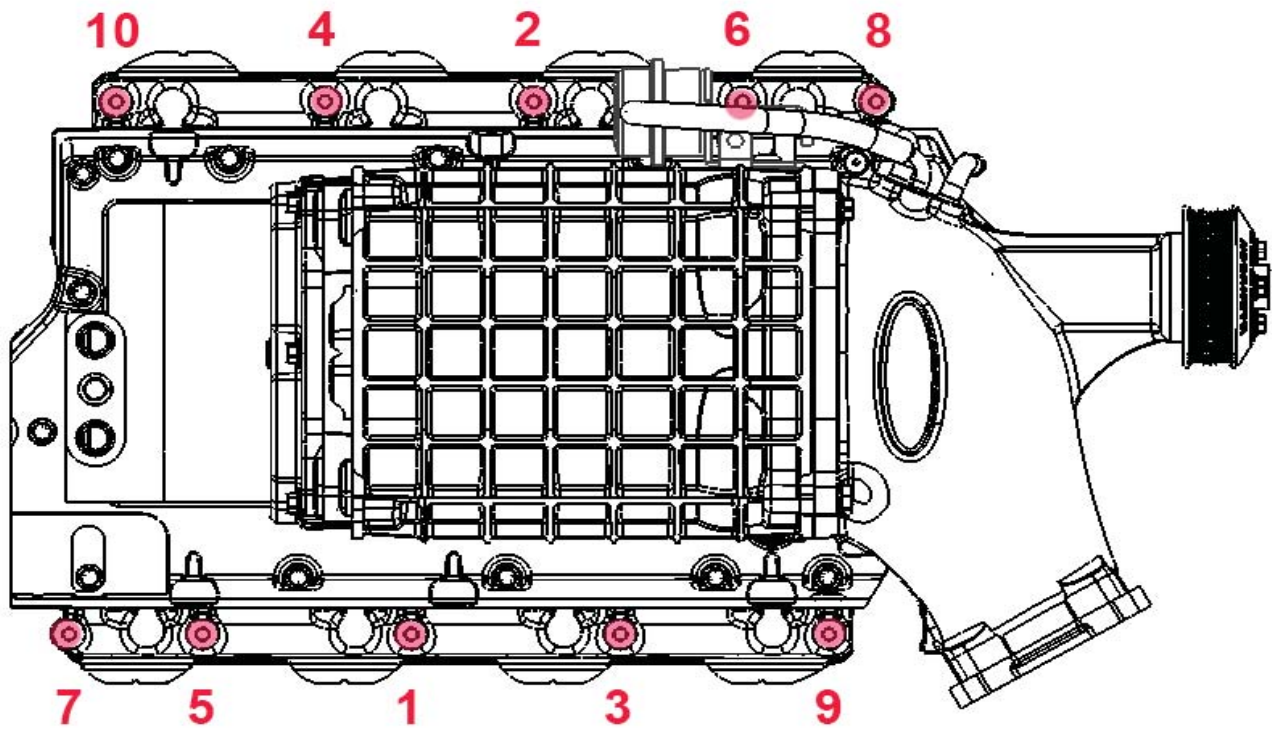

Supercharger Torque  
Order Diagram

# Diagrams

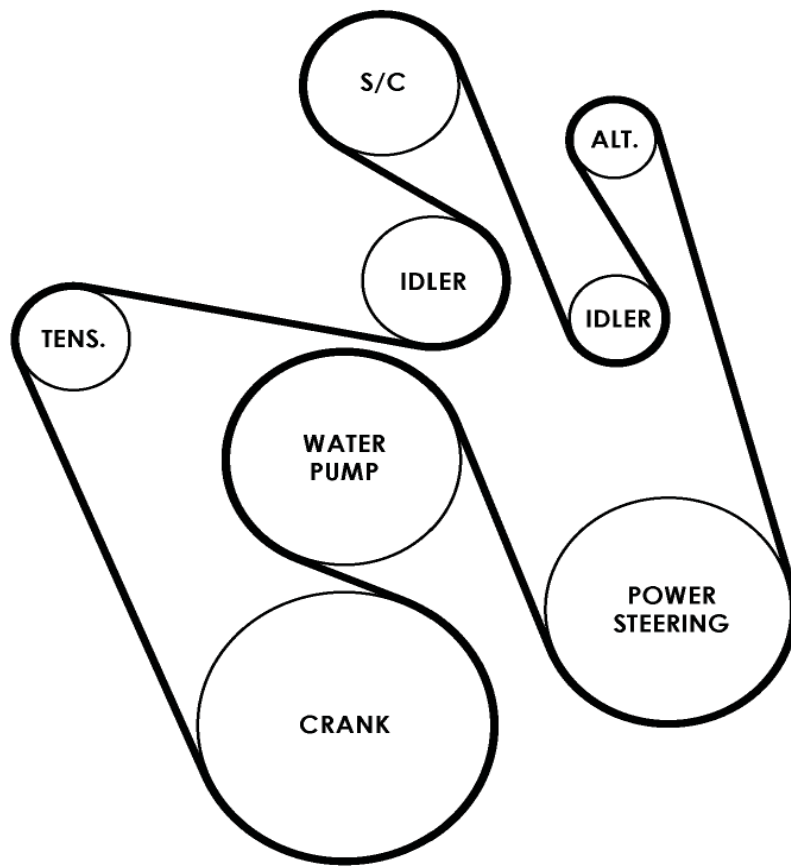

Belt Routing Diagram

## Reservoir to Pump

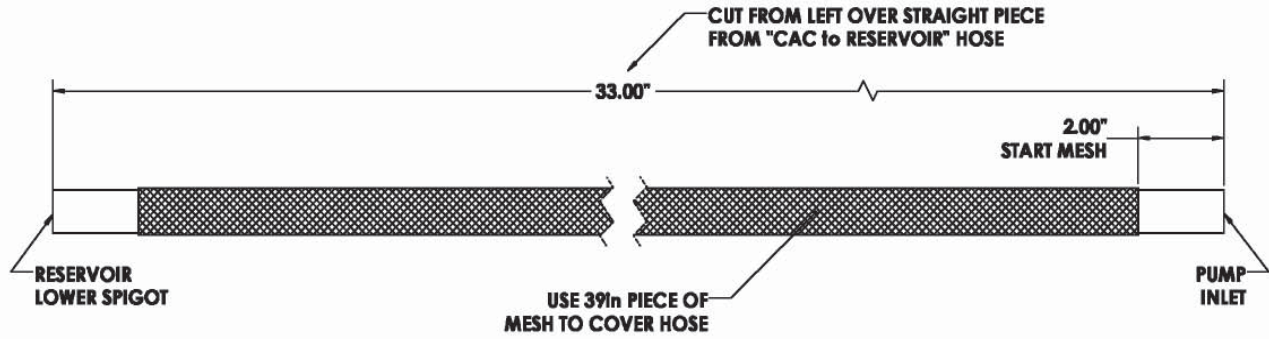

## Pump to LTR

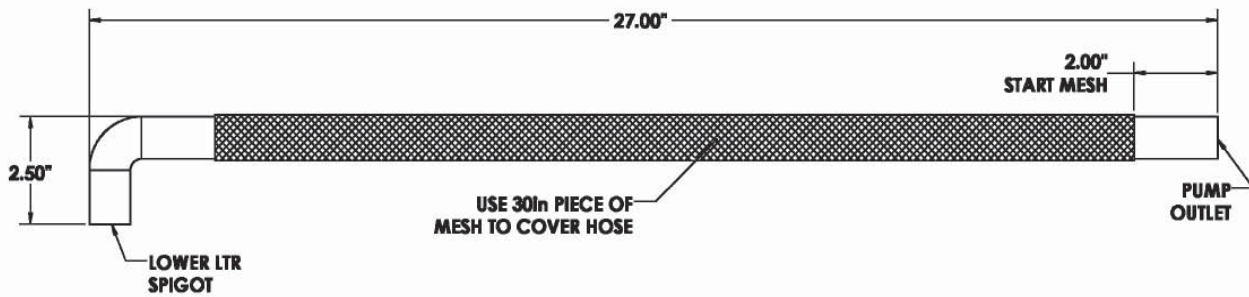

## LTR to CAC

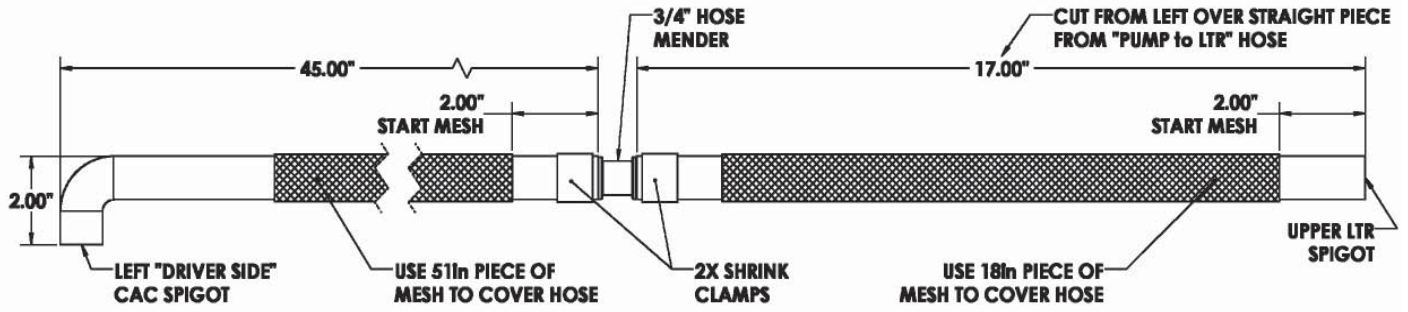

## CAC to Reservoir

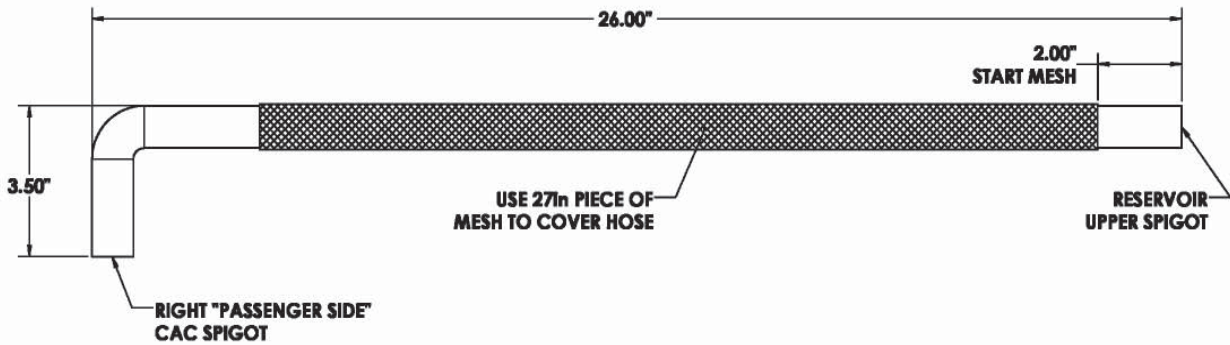

# Notes

# Notes



**This supercharger system requires the use of only premium gasoline fuel, 91 octane or better. It is NOT compatible with E85, Ethanol, Flex Fuels.**

***NOTE: Your supercharger system is sensitive to corrosion. You must use the GM specified coolant mixture in the intercooler system as well as your radiator.***



Please enjoy your "Magna Charged" performance responsibly!

**MAGNUSON**  
SUPERCHARGERS