



SUPERCHARGER INSTALLATION MANUAL

**2011-2017 DODGE RAM
5.7L ENGINE**



*WHIPPLE SUPERCHARGERS
3292 NORTH WEBER AVE
FRESNO, CA 93722
TEL 559.442.1261
FAX 559.442.4153*

www.whipplesuperchargers.com

*A color PDF of this manual is available, email
tech@whipplesuperchargers.com for a copy*

PREMIUM FUEL ONLY (91 OCTANE OR BETTER ALWAYS) RON+MON/2

CALIFORNIA AIR RESCOURCE BOARD EXECUTIVE ORDER #D231-46

**COMPETITION BASED PRODUCT MAY BE USED SOLELY ON VEHICLES USED IN SANCTIONED COMPETITION WHICH
MAY NEVER BE USED UPON A PUBLIC ROAD OR HIGHWAY**

INTRODUCTION

Before beginning installation, we encourage you to read this manual thoroughly before you begin any portion of the installation:

1. A quick parts check to make certain your kit is complete (see shipper parts list in packing paperwork). If you discover shipping damage or shortage, please call our office immediately.
2. Review our limited warranty with care.
3. Always wear eye protection during installation.
4. Avoid spills, if one occurs, clean up and dispose of towels properly.
5. Never work on a hot engine.
6. Obey all traffic laws when testing the vehicle.
7. **Whipple calibrations are for stock engines, changes such as long tubes, cams and big throttle bodies are not supported. Changes such as these will require custom tuning.**
8. Having the latest OEM PCM and TCM calibration is highly recommended to eliminate potential OEM issues in calibration.
9. COMPETITION BASED PRODUCT MAY BE USED SOLELY ON VEHICLES USED IN SANCTIONED COMPETITION WHICH MAY NEVER BE USED UPON A PUBLIC ROAD OR HIGHWAY, UNLESS PERMITTED BY SPECIFIC REGULATORY EXEMPTION (VISIT THE "EMISSIONS" PAGE AT [HTTP://WWW.SEMASAN.COM/EMISSIONS](http://www.semasan.com/emissions) FOR STATE BY STATE DETAILS.
10. COMPETITION BASED PRODUCT IS LEGAL IN CALIFORNIA ONLY FOR RACING VEHICLES WHICH MAY NEVER BE USED, OR REGISTERED OR LICENSED FOR USE, UPON A HIGHWAY.
11. IT IS THE RESPONSIBILITY OF THE INSTALLER AND/OR USER OF THIS PRODUCT TO ENSURE THAT IT IS USED IN COMPLIANCE WITH ALL APPLICABLE LAWS AND REGULATIONS.

RECOMMENDED TOOLS AND SUPPLIES

Extra Components

5.7L NGK 2315 or 4306 spark plugs (.028" gap), 6.4L use NGK 5107 (LZTR7AIX) with .028" gap, distilled water (1.5gal), approved coolant (1.5gal), 4", 8" and 12" zip-ties.



Tools

Torque wrench (1/4", 3/8", 1/2") Safety glasses, metric wrench set, assorted drill set, electric or air drill, 1/4", 3/8", 1/2" assorted metric socket set, 3/8" assorted metric allen socket set, 3/8" assorted torx socket set, 8mm hex allen wrench, flat head and phillips screw drivers, pinch clamp tool, 8mm nut driver and drain pan (for coolant).

Tie Straps

These will be useful for securing the wiring harness away from the installation area as directed in the instruction manual. They are inexpensive and will be very handy during installation.

Sealants

Blue Loctite™ #242 or equivalent, Red Loctite™ #271 or equivalent, Green Loctite™ #648 or equivalent. All bolts that need Loctite™ are marked with:  Loctite™ (#242 blue) threads,  Loctite™ (#271 red) threads,  Loctite™ (#648 green). Thread sealant such as pipe Teflon must be used on all pipe threads.

Chemicals and lubricants

You will need some cleaner/degreaser such as carb cleaner. Motor oil and clear automotive-type grease will be useful as a lubricant and should be readily available during installation.

You'll be required to fill your intercooler system with approx. 1 gallon of distilled water and Dodge/Chrysler/Jeep approved engine coolant. This is not supplied in the system, you can find the coolant at any local auto parts store. NEVER USE TAP WATER, as it can corrode and create poor performance.

Clean Shop Towels

Use these to keep the installation area clean.

PRE-INSTALLATION CHECKLIST

Before installing your Whipple Supercharger Kit, complete the following checklist.

1. Verify Condition of Vehicle: Before the supercharger kit is installed, ensure the engine runs smoothly and that the factory malfunction indicator light (MIL) is off. Only install the supercharger kit if the engine runs smoothly *and* the MIL is off.
2. **!! CAUTION !!** This product is intended for use only on STOCK, UNMODIFIED, WELL-MAINTAINED engines. Installation on a worn-out or modified engine is not recommended without factory computer and fuel system modifications. Custom engine configurations could require custom tuning and other supporting modifications.
3. **!! CAUTION !!** Use only 91 octane fuel or higher. If fuel of less than 91-octane is present in the vehicle fuel tank, the tank must be completely drained and refilled with 91 or higher octane to 1/8th of a tank.
4. Verify Fuel System: Supercharger systems should only be installed on vehicles that have new or clean fuel filters. Fuel PSI should be steady 58psi in factory form. **Never operate at wide open throttle when fuel level is below ¼ tank. Fuel flow cannot be maintained if the pump runs dry.**
5. Assess Cleanliness of Installation Area: Make sure your work area and the under-hood area are free from debris. This supercharger is a high-quality, close-tolerance compressor and must not be subjected to contamination by dirt or any type of foreign material. If necessary, vacuum around engine to remove any foreign material.
6. **!! CAUTION !!** **DO NOT** remove the protective seal on the supercharger prior to installation. Foreign material entering the supercharger will automatically void all warranties.
7. Identify Supercharger Kit Components: Before beginning installation, identify all the components of your Whipple Supercharger Kit and ensure all items are present and undamaged.
8. **!! CAUTION !!** Do not attempt to start the engine before adding the supplied supercharger oil to the supercharger!

SAFETY PRECAUTIONS



CAREFULLY READ THE IMPORTANT SAFETY PRECAUTIONS AND WARNINGS BEFORE PROCEEDING WITH THE INSTALLATION!

Appropriate disassembly, assembly methods and procedures are essential to ensure the personal safety of the individual performing the kit installation. Improper installation due to the failure to correctly follow these instructions could cause personally injury or death. Read each step of the installation manual carefully before starting the installation.

- Always wear safety glasses for eye protection.
- Place the ignition switch in the off position.
- Always apply the parking brake when working on vehicle.
- Block the front and rear tire surfaces to prevent unexpected vehicle movement.
- Operate the engine only in well-ventilated areas to avoid exposure to carbon monoxide.
- Do not smoke or use flammable items near or around fuel system.
- Use chemicals and cleaners only in well-ventilated areas.
- Batteries can produce explosive hydrogen gas which can cause personal injury. Do not allow flames, sparks or flammable sources to come near the battery.
- Keep hands and any other objects away from the radiator fan blades.
- Keep yourself and your clothing away from moving parts when the engine is running.
- Do not wear loose clothing or jewelry that can be caught in rotating or moving parts.

Symbol Key

Throughout this installation guide you will see the following symbols used:

NOTE

Used to indicate tips and information to aid in installation, maintenance, or use of the supercharger.

!! CAUTION !!

Used to indicate precautions that must be taken to avoid damage to the supercharger and associated components.

WARNING!!

*Used to indicate precautions that must be taken to avoid **bodily injury** as well as damage to the supercharger and associated components.*

COMMON ABBREVIATIONS

ABBREVIATION	DESCRIPTION
DTC	Diagnostic Trouble Code
ECT	Engine Coolant Temperature
EGR	Exhaust Gas Recirculation
ETC	Electronic Throttle Control
EVAP	Evaporative emissions system
FHSCS	Flat Head Socket Cap Screw
IAT	Inlet Air Temperature
IC	Intercooler
ID	Internal Diameter
IN/LB	Inch pounds
LB/FT	Foot pounds
MAF	Mass Air Flow
MAP	Manifold Absolute Pressure
MY	Model Year
OBD	On Board Diagnostics
OD	Outside Diameter
PCV	Positive Crankcase Ventilation
PSI	Pound per Square Inch
SC	Supercharger
SHCS	Socket Head Cap Screw
TPS	Throttle Pressure Sensor
TRQ	Torque

➔ NOTE

****NOTICE:** Installation of Whipple Supercharger products signifies that you have read this document and have agreed to the terms stated within.

It's the purchaser's responsibility to follow all installation instruction guidelines and safety procedures supplied with the product as it's received by the purchaser to determine the compatibility of the product with the vehicle or the device the purchaser intends to install the product on.

Whipple Superchargers assumes no responsibility for damages occurring from accident, misuse, abuse, improper installation, improper operation, lack of reasonable care or all previously stated reasons resulting from incompatibility with other manufacturer's products.

There are no warranties expressed or implied for engine failure or damage to the vehicle in any way, loss of use or inconvenience or labor reimbursement. This includes merchantability and fitness.

 **NEVER SMOKE DURING THE INSTALLATION OF THE SC, THERE WILL BE FLAMMABLE FUMES AND LIQUID AROUND THE VEHICLE**

ILLUSTRATED INSTALLATION GUIDE

It is strongly recommended that you read through this guide before you begin installing the Whipple Supercharger.

 **WARNING!!** Batteries normally produce explosive gases. Therefore, do not allow flames, sparks or lighted substances to come near the battery. When charging or working near a battery, always shield your face and protect your eyes. Always provide ventilation. Failure to follow these instructions may result in personal injury.

 **WARNING!!** Keep out of the reach of children. Batteries contain sulfuric acid. Avoid contact with skin, eyes or clothing. Also, shield your eyes when working near the battery to protect against possible splashing of the acid solution. In case of acid contact with the skin or eyes, flush immediately with water for a minimum of 15 minutes and get prompt medical attention. If acid is swallowed, call a physician immediately. Failure to follow these instructions may result in personal injury.

1. (Complete kits only) Using the supplied flash tool, connect to the vehicle's OBDII port and follow the on-screen instructions to read factory calibration strategy code (**SCT only**). Email tuning@whipplesuperchargers.com to get your modified version of the calibration. Note: Make sure your battery is fully charged before installing, if not, install a battery charger to maintain 14volts. Modified engines such as long tubes, camshafts or oversized throttle bodies are not supported. **Calibrations take 24-48 hours to build**, make sure to do this before installation. In rare cases, a PCM strategy may not be supported. It is always good to update the PCM before starting the installation to ensure you have the latest updates from the factory.
2. Using an air hose, blow off any loose dirt or debris from engine compartment. If really dirty, then steam clean the engine compartment before proceeding to the next step.
3. Access to the bottom of the radiator and front end is required, if the vehicle does not have adequate access or is lowered, raise the front of the vehicle with a service lift or equivalent. On the lower driver side of radiator, use a 16mm socket, carefully loosen the petcock bolt to drain the coolant into a coolant reservoir. Tighten petcock bolt.
4. Slowly remove the factory gas cap to relieve any excess pressure.

5. With a 10mm wrench disconnect the (-) negative battery cable. Make sure the cable is far enough away from the battery that it does not accidentally touch the battery and make connection during the installation.
6. Using a panel puller, remove (4) small body pins and (2) larger body pins securing radiator cover.



7. Using a 10mm socket, remove (4) bolts securing griller to radiator core support.



8. (Grill detachment varies per model) Earlier model years will detach (2) metal retaining clips and (2) plastic retaining clips. Later model years will detach (1) center tab and (4) plastic push pins. Detach grill appropriately and remove.

LATE MODELS

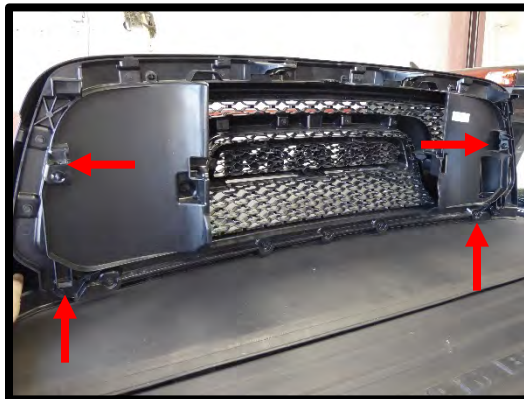

9. Unplug the air intake temp sensor from the intake tube. Remove the intake tube from the throttle body and airbox using a flathead screwdriver or 5/16" nut driver.

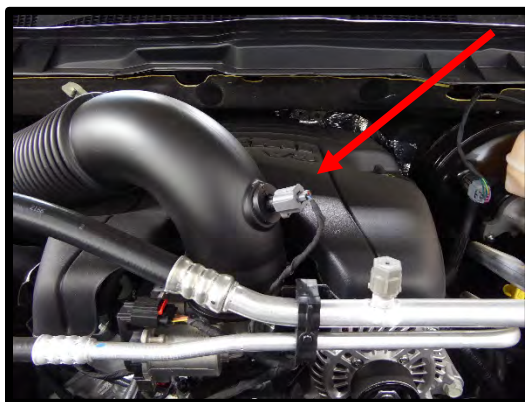

10. Remove the engine cover by pulling up, this will not be reused.
11. Disconnect the throttle body electrical connector.
12. Remove the driver side PCV hose from the airbox and driver side valve cover/oil catch can.

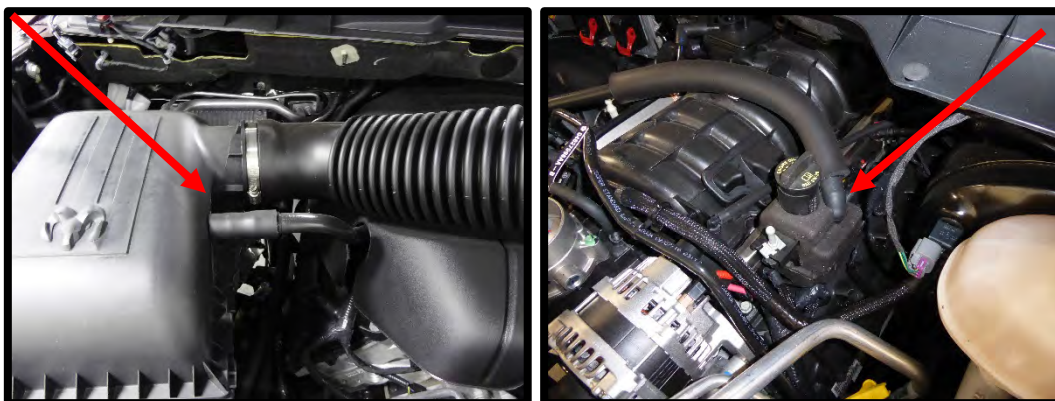

13. Remove the passenger side PCV hose from barb under throttle body and barb at back of intake manifold.

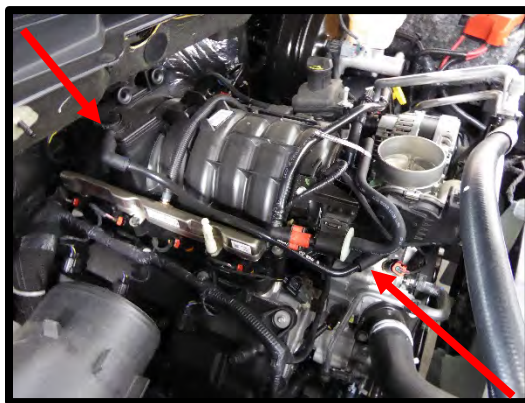

14. (EVAP mounted on driver side fender/early models) Remove the EVAP hose from the manifold and EVAP solenoid.

15. (EVAP mounted on intake manifold) Remove EVAP hose from the EVAP solenoid and from the barb located on the firewall below the brake booster. Remove the (3) plastic clamps securing EVAP line to A/C and breather lines.

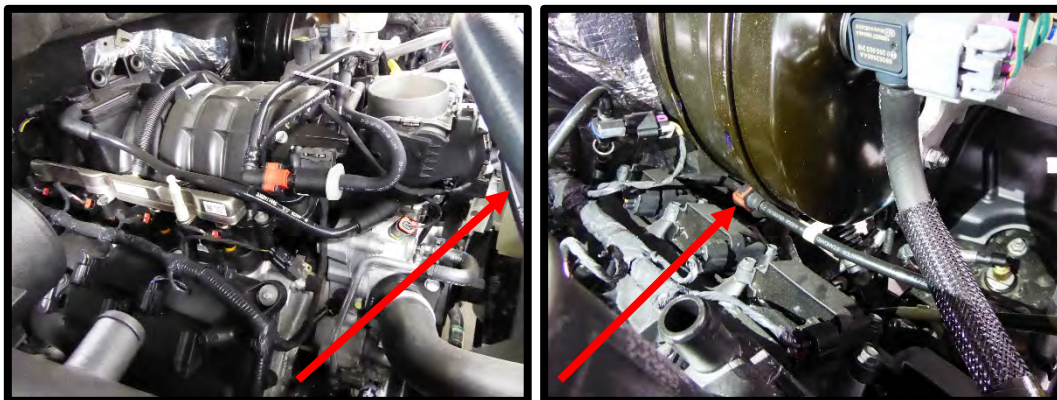

16. (EVAP mounted on intake manifold) Unplug the EVAP connector and disconnect the second EVAP hose from solenoid. Remove the EVAP solenoid from the manifold and set aside as it will be reused later.

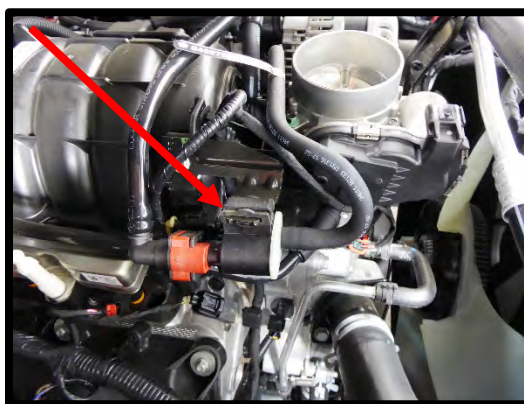

17. Remove brake booster hose from intake manifold. This hose will be reused.

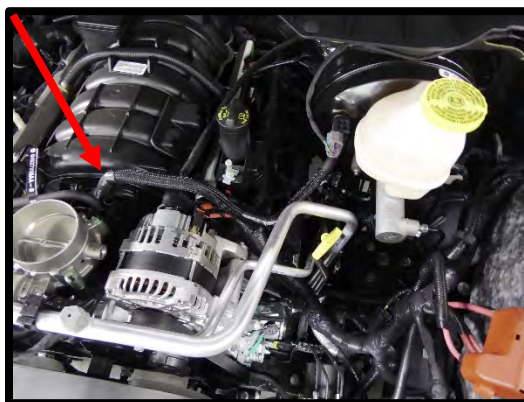

18. Using a small flat head screwdriver, remove the AC support strap from the A/C lines (this will be reused). Unthread this from the bracket.



19. Using a panel puller, remove the (2) push pins securing wiring harness to A/C line support bracket and (1) secured to intake manifold.

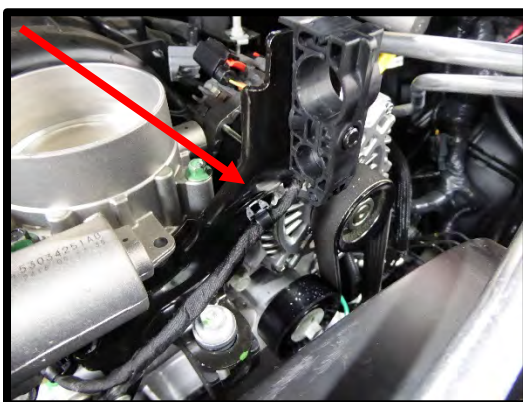

20. Using a panel puller, remove transmission vent line from manifold and fuel feed line.

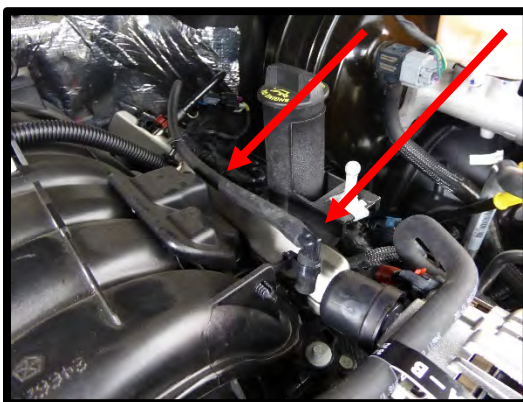

21. Using a 13mm socket, remove the bolt and nut securing the A/C line support strap.

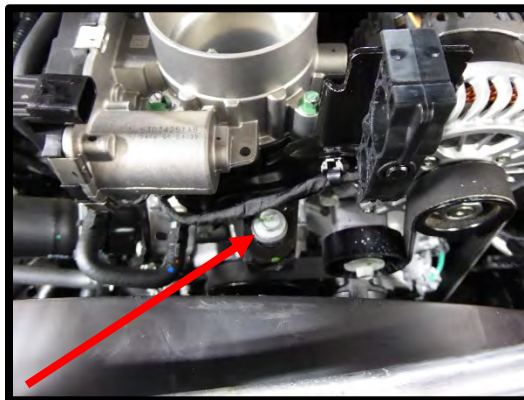

22. Unplug the active runner connector at the back of the intake manifold. Disconnect (2) harness clips from firewall to relieve wiring harness. Using electrical tape, cover the active runner control connector to prevent water damage as this will not be reused.

23. Unplug the factory MAP sensor connector at the back/top of the intake manifold.



24. Disconnect fuel pressure sensor where applicable (not all models have this).



25. **WARNING!!** Disconnect factory fuel feed line from fuel rail. Early model years, remove the fuel safety clip from the fuel feed line then disconnect the fuel feed line from the fuel rail using a 3/8" fuel line removal tool. Later model years need to lift up the red locking tab and then depress the red locking tab from both sides to remove fuel line. Cap the fuel rail to avoid excess fuel spillage.



26. Disconnect (8) fuel injector electrical connectors.
27. Using an 8mm socket, remove the (10) manifold bolts. Carefully lift the manifold from the engine. Use a clean shop rag and acetone or other cleaner and clean the intake manifold to cylinder head surface. Apply masking tape to the head ports to prevent dirt and debris.
28. Using a 3/8" breaker bar, release the tension from the belt tensioner and remove the drive belt.
29. Unplug the connector from the alternator. Using a 13mm socket, remove the alternator power wire.

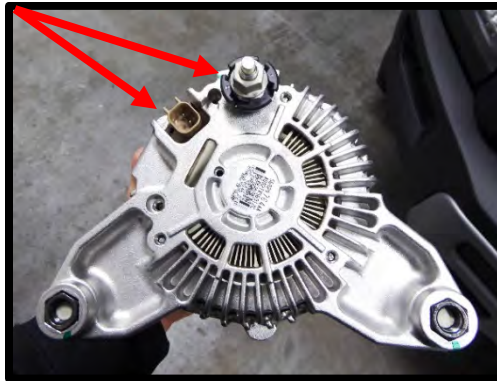

30. Using a 15mm socket, unbolt alternator and remove from engine.

31. Using a 13mm socket (10mm on some), remove the support bar from the alternator bracket.

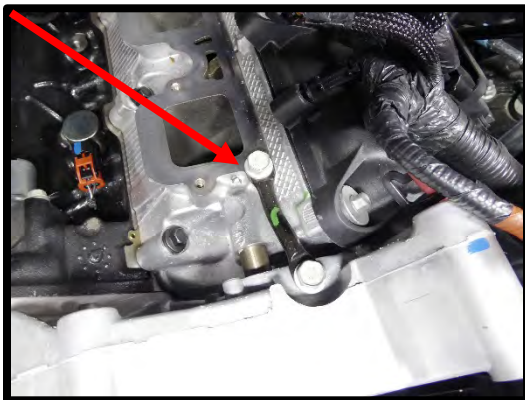

32. Carefully detach the lower fan shroud (under vehicle).



33. Using a panel puller, detach the splash guard from the fan shroud (push pins do not have to be removed).



34. Using a hose clamp tool, remove the upper radiator hose from radiator.

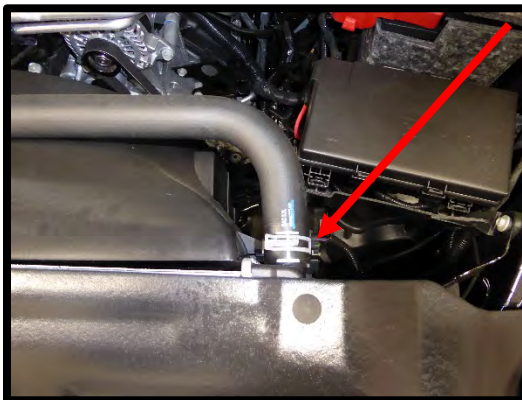

35. Disconnect the electronic fan connector.

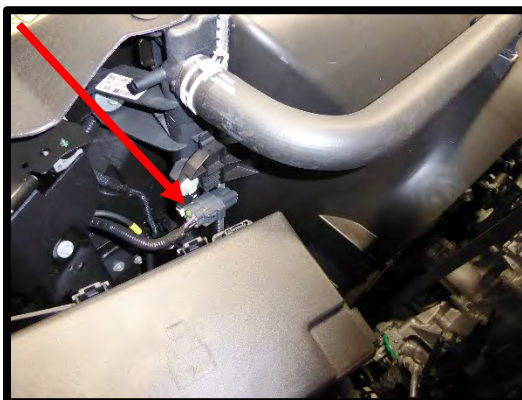

36. Remove the (2) factory bolts securing fan (1 per side) shroud to radiator using a 13mm socket.

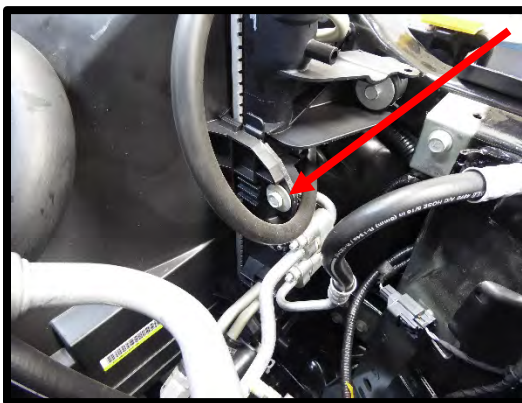

37. Detach fan shroud from locking tabs. Position the shroud towards the engine. Depress the plastic retaining clips on each side of the fan assembly and pull up to detach the fan assembly. Lift electric fan assembly from vehicle.



38. Carefully blow off any debris from the damper. It's a good idea to place some rags, blanket or tape over the radiator so debris does not get stuck inside the fins.
39. Using a ½" impact gun and a 21mm socket, remove the factory damper pulley center bolt. If you do not have access to air ratchet, you will need flywheel/flexplate holding tool to prevent engine from rotating.
40. Install the supplied 14mm stud into the crank pinning adapter about halfway up the threads. Install stud and crank pin adapter into damper until snug (apply light amount of anti-seize to threads). Use a 1" wrench or a crescent wrench to tighten so it does not move while drilling.

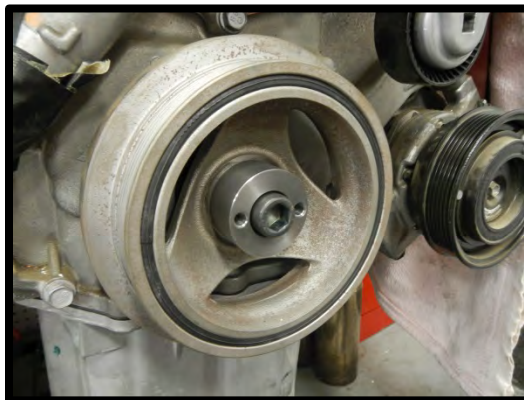

41. Use the supplied 1/4" drill bit (it has a stop at roughly 2.875" from drill bit tip), drill 2 holes into the crankshaft thru the (2) holes in the pin adapter. Blow off debris when done drilling. Remove the pin adapter using an adjustable wrench.

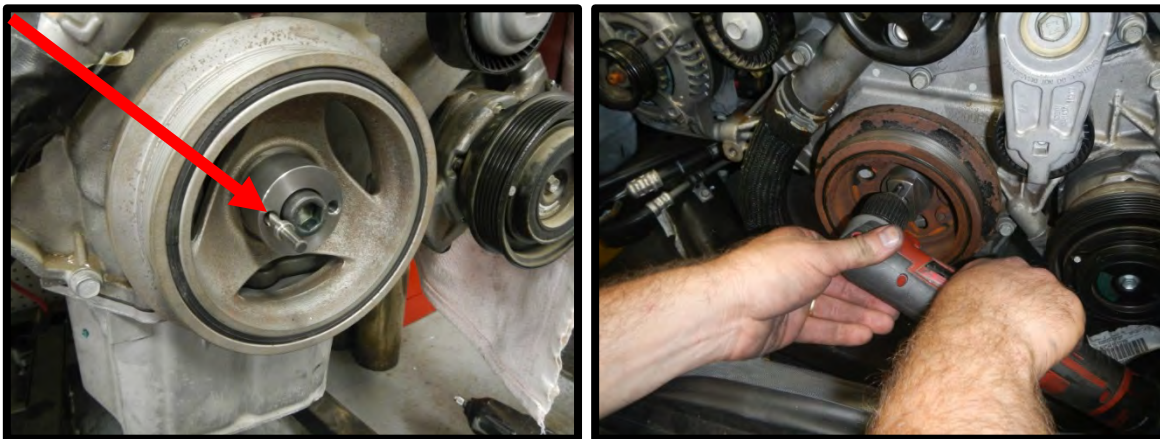

42. Install the supplied 1/4" dowel pins with a generous amount of green Loctite #648. Use a hammer and punch or drift pin to tap in so they are flush.

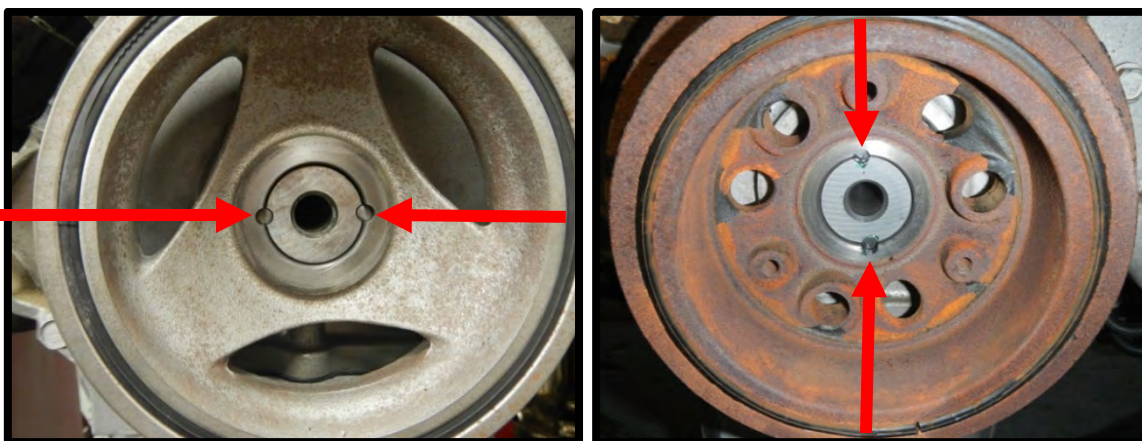

43. Apply light amount of anti-seize to threads of the factory damper pulley. Use a 21mm socket and torque to 129 ft/lbs. ****DO NOT LET BALANCER ROTATE WHILE TORQUING.**



44. **(Complete kits)** Remove the (8) coil electrical connectors. Remove the coils using a 10mm socket and ratchet (2 bolts per coil). Lift the coil out and use a 5/8" spark plug socket and ratchet to remove the stock spark plugs (16). **GAP TO .028"**. Apply light amount of anti-seize and reinstall. Torque to 13 ft-lbs.

45. Install the alternator bracket bushing to the alternator bracket. Install the bracket and alternator to the factory mount, secure using the factory bolt. Secure back with the supplied (1) 10mm nyloc nut and washer. On bottom bolt, use the factory bolt to secure tensioner, sandwich the supplied AC line support bracket to alternator mount and factory bolt.

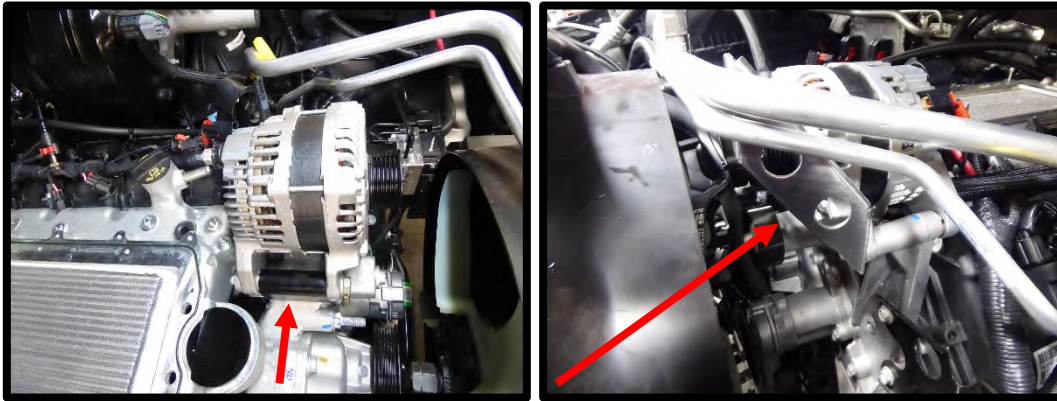

46. Reconnect power wire and electrical connector. Push plastic clip for power wire protection back in place.

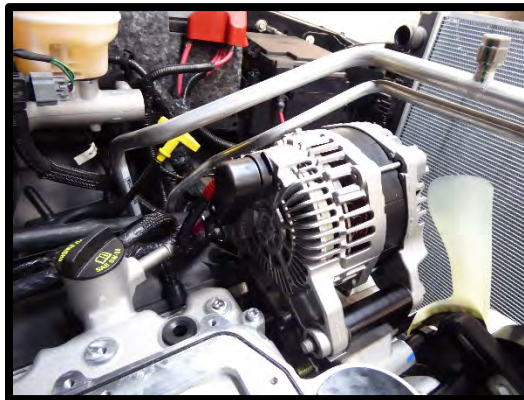

47. Install the factory air temp sensor into the supplied rubber grommet above the #1 cylinder. Apply generous amount of grease to air temp sensor and press into rubber grommet. Make sure the sensor locking tab is facing the driver side, before pressing in, it's good to double check that you can always get to the electrical connector unlocking tab.



48. Install the supplied PCV valve into the intake manifold, passenger side.

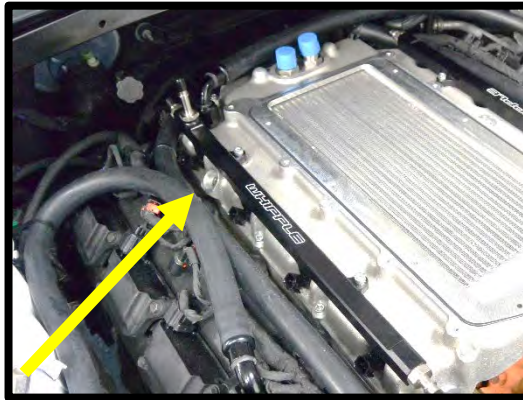

49. Modify the supplied 2-bar MAP sensor (PN# 1-05033224AB) by carefully removing the factory tang. It's best to use a box cutter/razor or a Dremel tool.

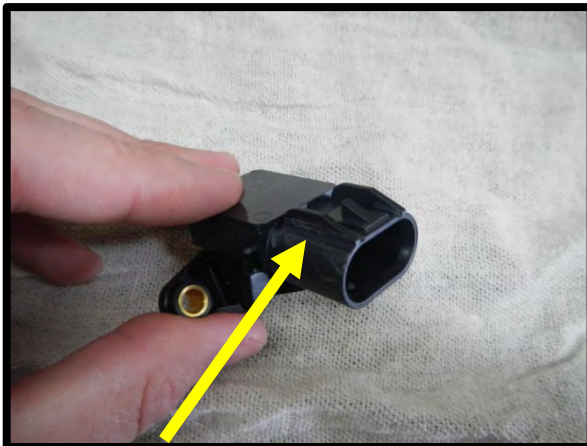
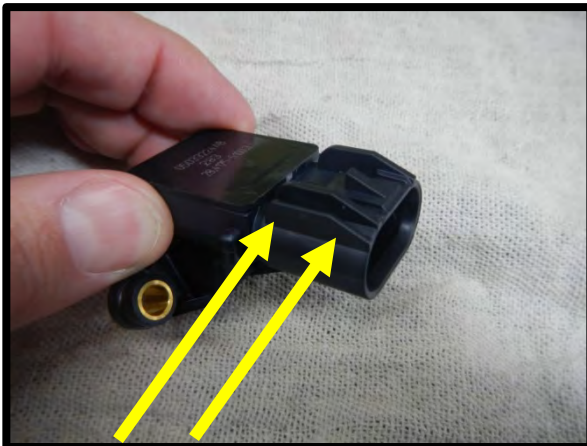

50. Apply generous amount of grease to the supplied 2-BAR MAP sensor oring. Install the supplied MAP sensor to the back of the lower intake manifold by lightly pressing the oring barb through the .590" passage on the back of the lower intake manifold. Use the supplied 5mm x 16mm SHCS (2) bolts to secure sensor to lower manifold. Torque to 50 in/lbs.



51. For shipping, the manifold assembly is bolted together with (4) 6mm bolts. Use a 5mm allen socket and ratchet to remove the (4) 6mm bolts (save for later use). Break the compressor assembly apart, gently setting the compressor assembly down. Do not set on anything sharp.

52. Remove the tape you previously installed on the cylinder head to intake manifold surface. Clean off any excess glue using acetone or carb cleaner.
53. Set the supplied intake gaskets onto the cylinder head to intake manifold surface, lining up ports and bolt holes.
54. Apply light amount of automotive grease to PCV/Breather oring passage. Install the supplied PCV/Breather passage orings (2) to the lower intake manifold. Make sure to rub the grease all over the oring so it does not move and cannot rip during upper manifold installation.

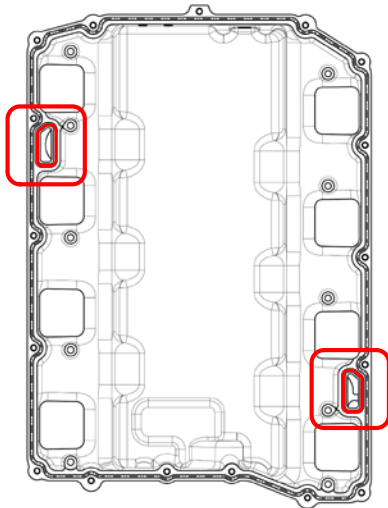

55. Install the supplied lower intake manifold to the engine. Be careful to lineup each port, as well as the intake gaskets underneath. Once aligned, secure the intake manifold with the (10) supplied 6mm x 22mm socket head cap screw with a light amount of blue Loctite to the threads. Note that the heater tube is close to the intake manifold, if they are touching with the intake manifold lined up to the ports, use a pry bar to carefully bend away from the intake manifold. Torque to 9 ft/lbs. in the following pattern:

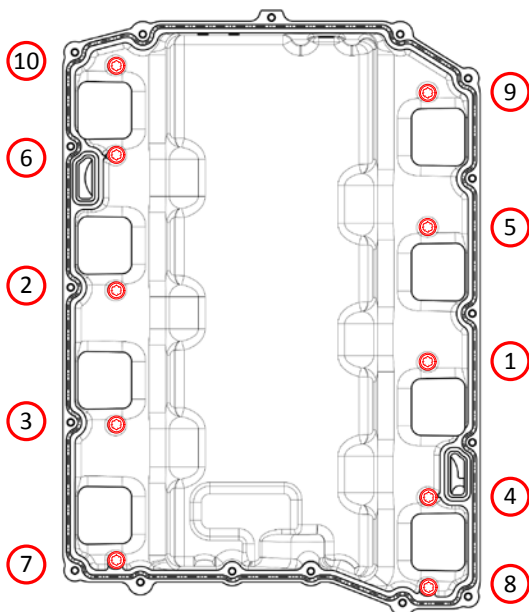

56. Carefully place the upper intake manifold assembly to the lower intake manifold. Be careful to not slide the assembly much, as you could grab an oring. Use the previously installed (for shipping) (4) 6mm x 25mm socket head cap screws, along with the supplied (4 of 6) 6mm x 25mm socket head cap screws to secure the outer portion of the upper intake manifold to the lower intake manifold assembly. Carefully install the (2 of 6) 6mm x 25mm socket head cap screws through the 2 passages at the bypass area. It's best to put the bolt on the end of an allen socket and use your fingers through the bypass passage to guide the bolts into the mounting holes. Install the supplied (5) 6mm x 60mm socket head cap screws to the 5 center mounting holes. Install all hand tight using a 5mm allen socket.

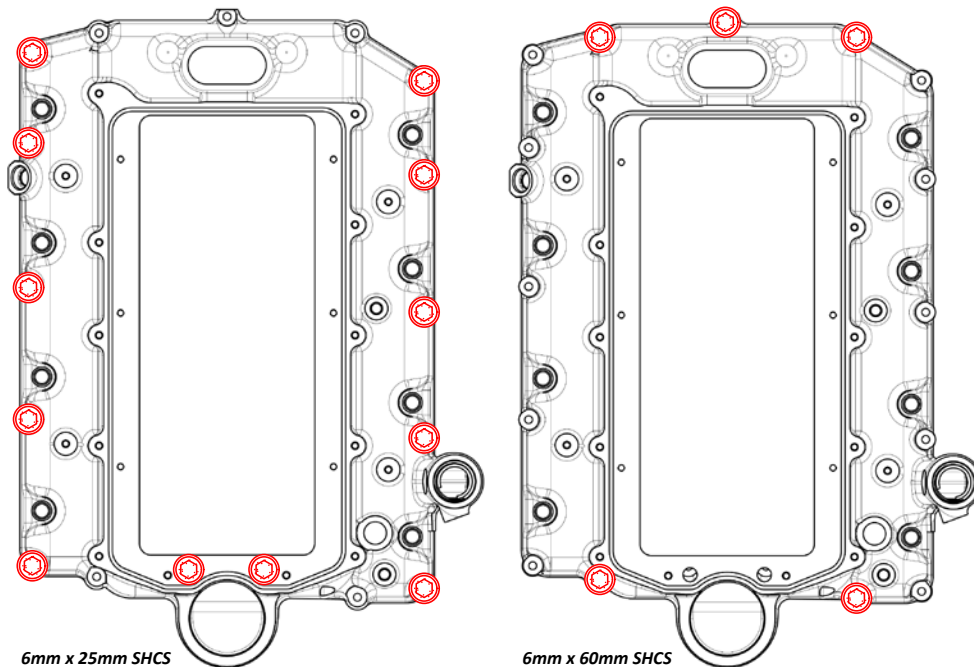

57. Using a 5mm allen socket and a torque wrench, torque the 6mm upper manifold bolts to 9 ft/lbs using the following torque sequence:

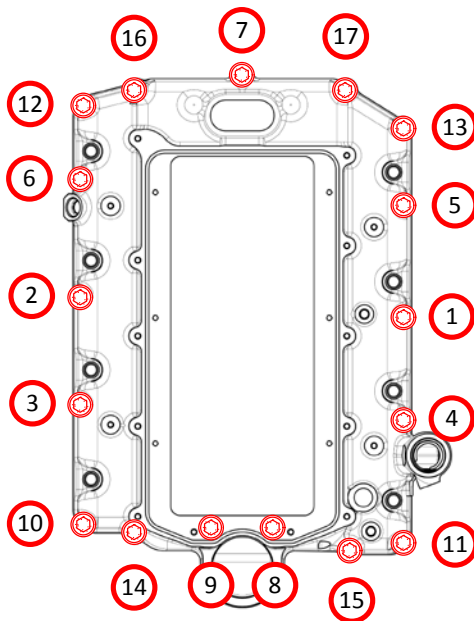

58. Install the supplied oring to the passage block off puck. Apply light amount of grease to oring and install puck into manifold as shown. Note: The position is critical to clear the supercharger adapter plate.



59. Install the factory 1/2" hose 90deg to the oil fill barb. Route hose under the front of the manifold and between water pump housing and block. Leave on passenger side of valve cover for later installation to airbox.

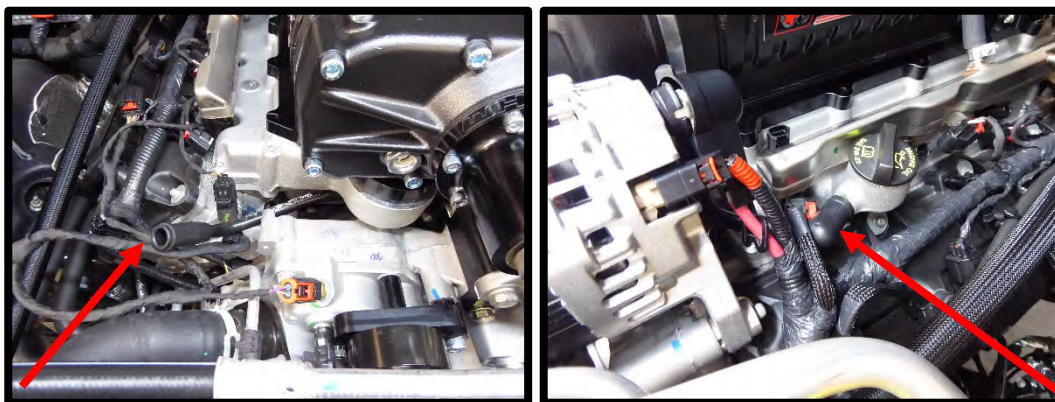

60. Using a razor blade, carefully cut the factory EVAP quick connect fittings from the factory hose. Install these into the supplied 1/2" x 39 1/2" hose. Route this hose with the straight fitting going to the passenger side of vehicle between the front of the manifold and water pump/alternator assembly for later installation.

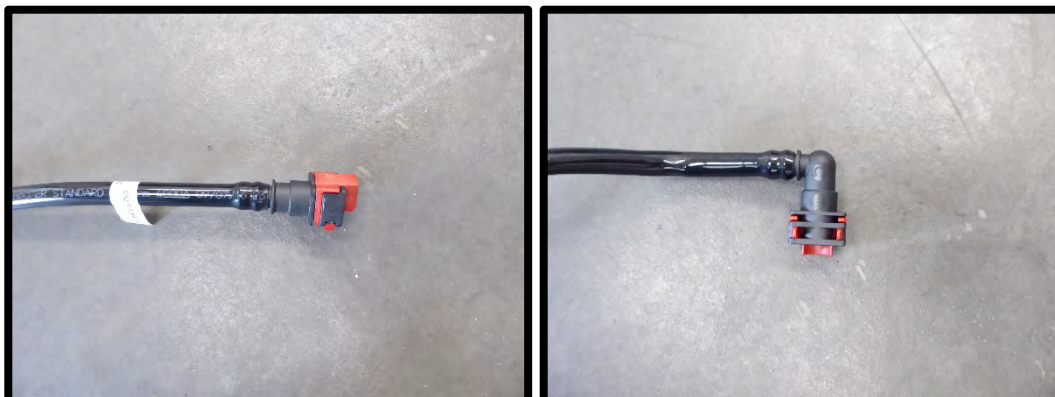

61. (When applicable) Rotate the hose clamp for the thermostat vent line away from center so it doesn't interfere with the idler pulley.

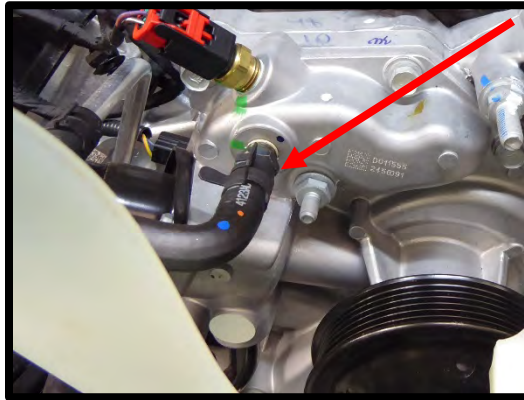

62. Remove the (3) factory fasteners at the water pump assembly using a 13mm and 15mm socket. Install the supplied idler assembly to this location. The idler plate and stand are each marked to their respective position. Use the 8mm x 130mm SHCS on the passenger side bolt hole with the .4525" spacer, 8mm x 140mm SHCS on the center hole with the 1.675" spacer, the 10mm x 55mm SHCS with the .865" spacer. Torque the 8mm bolts to 22 ft-lbs and the 10mm 45 ft-lbs.



63. Install the sliding tee nut on the back of the idler plate. Install the .390" idler pulley spacer, the idler pulley, the step spacer and the 1/2" x 1 1/2" SHCS. Leave loose until belt installation.
64. Remove the factory plastic 6-rib smooth idler pulley from alternator bracket. Replace with supplied steel 6-rib idler pulley using factory hardware.

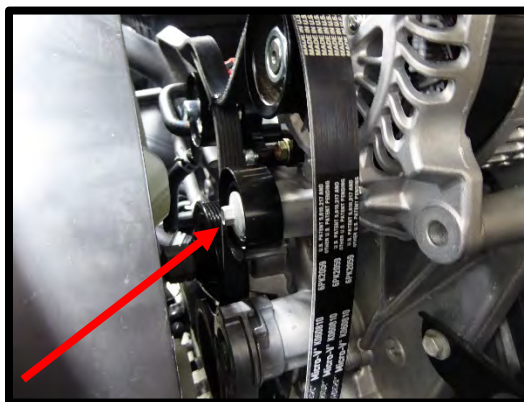

65. Install the 5/8" x 42" intercooler hose to the passenger side intercooler fitting. Secure to fitting and route along the passenger side valve cover to the passenger side of radiator for later installation.



66. Install the 5/8" x 34" intercooler hose to the driver side intercooler fitting. Secure to fitting and route along the driver side valve cover to the driver side of radiator for later installation.



67. Install (2) of the supplied 1/2" rubber grommets to the LTR bracket. Apply light amount of grease in the ID of grommet. Install the LTR bracket to the factory frame using the (2) 6mm x 20mm HHFCS. Torque to 106 in-lbs.

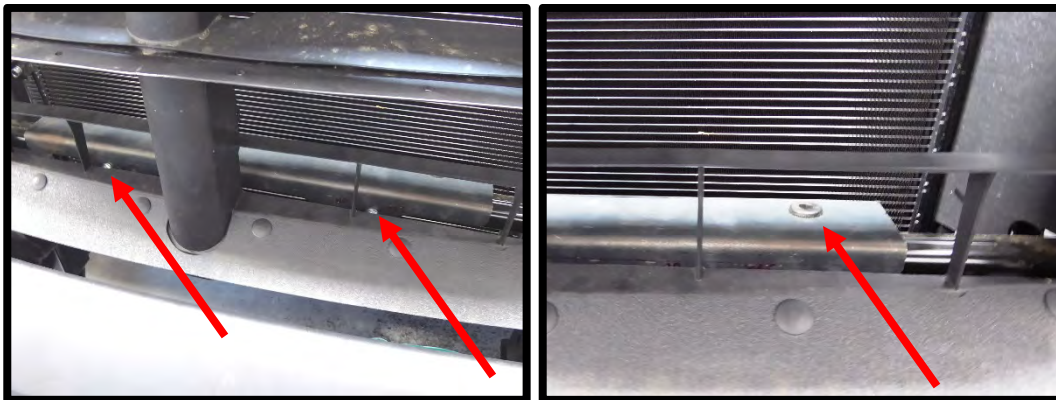

68. Install the supplied (2) rubber grommets into the LTR brackets. Apply light amount of grease to ID for easy installation.



69. Install the supplied (2) 4" long foam strip vertically on the inlet and outlet tank of the LTR, at the top. Cut the 3rd 4" foam strip into (2) 2" pieces. Flip the LTR over and install on the top inlet and outlet tank of the LTR. Install the (2) supplied 1/2" rubber grommets to the LTR mounting brackets. Apply light amount of grease in the ID of grommet.

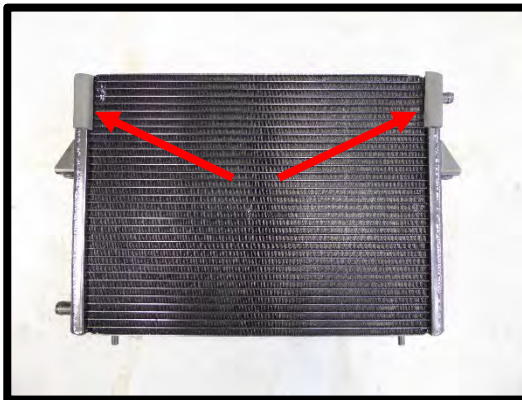

70. Carefully slide the LTR down in between the condenser and core support. LTR pins will sit in rubber grommets. Driver side fitting is down, passenger side is up at the top.

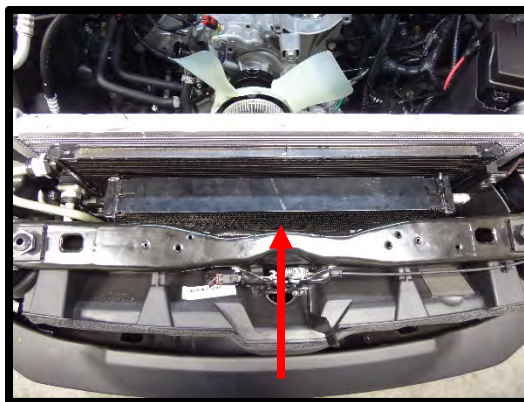

71. Using a 10mm socket, remove the (2) factory hex bolts securing condenser to radiator on driver side. Install the supplied LTR bracket by sliding the locating pin into the LTR grommet. Secure with factory bolts.

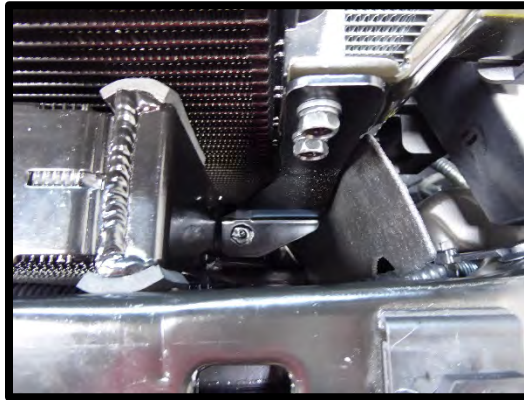

72. Using a phillips screw driver, remove the (2) factory hex bolts securing condenser to radiator on passenger side. Install the supplied LTR bracket by sliding the locating pin into the LTR grommet. Secure with factory bolts using a phillips screw driver.

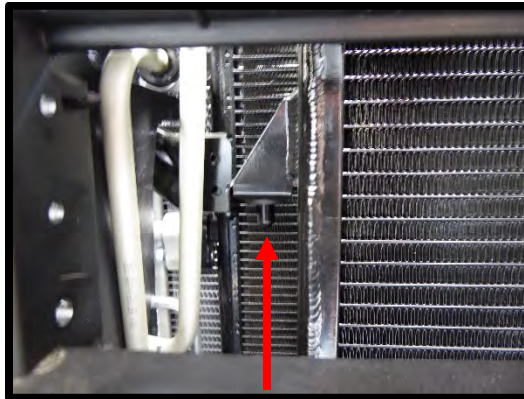

73. Install the supplied S bend hose from the LTR driver side barb fitting and route to the fuse box area for later installation to IC pump. Secure end with pinch clamp. Note: Image shows hose on IC pump for proper orientation view.



74. Install the IC pump to the IC reservoir by installing the supplied clamp and rubber strip (leave slightly loose to position after hose installation). Once pump is in position, tighten clamp.

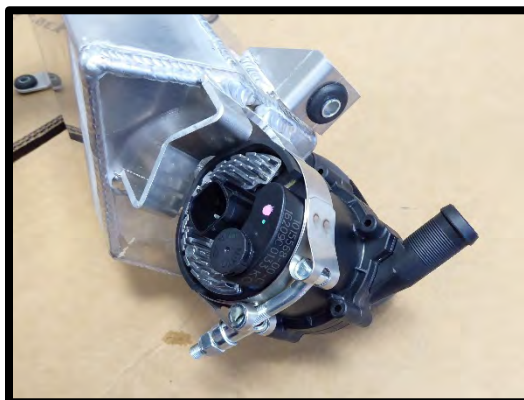

75. Install the supplied (3) rubber grommets into the 3 mounting flanges of the IC coolant reservoir.

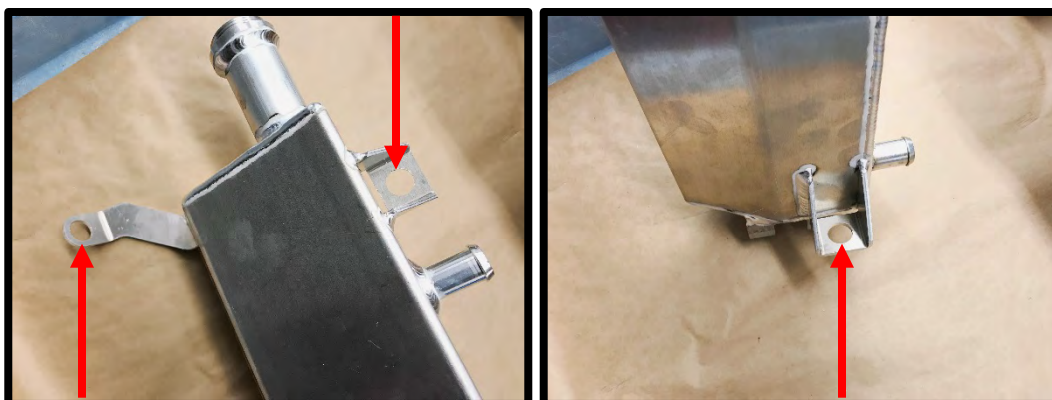

76. Install the supplied U bend hose from the IC reservoir to the IC pump. Secure both ends with the pinch clamps.

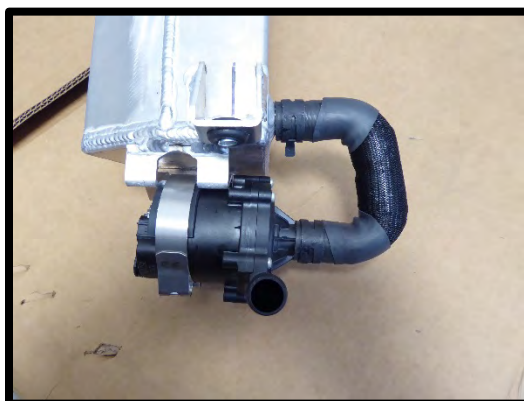

77. Remove the factory 2 bolts, install the IC reservoir mounting bracket to the frame and secure with the factory bolts.

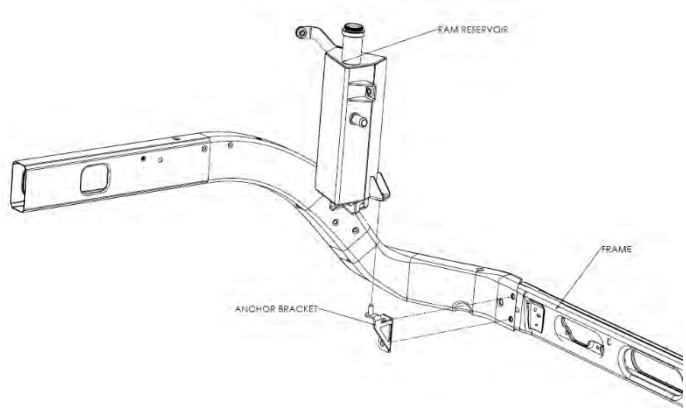
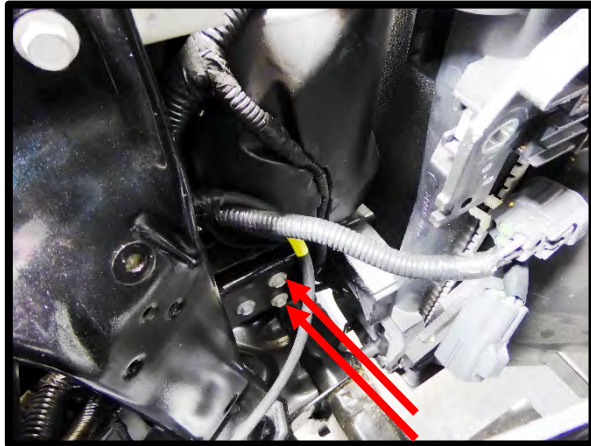

78. Mount the intercooler reservoir and pump assembly to the passenger side inner fender area. Use the factory fasteners in the (2) positions (driver side fender and fan shroud fastener). Reinstall fan shroud while installing reservoir. Reconnect electric fan connector.

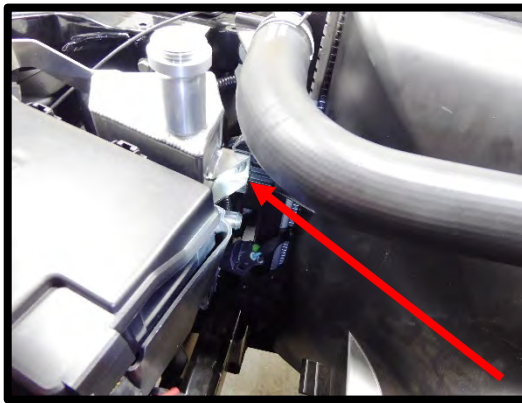
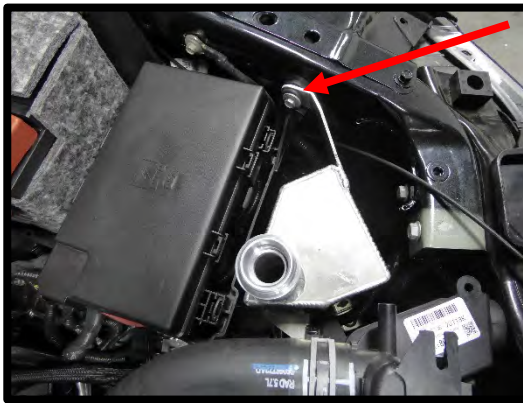

79. Secure pre-routed driver side IC hose to IC reservoir barb fitting. Secure with pinch clamp.



80. Install the previously installed S bend hose from the LTR driver side barb fitting to the IC pump outlet fitting. Secure both ends with pinch clamps (image shown off vehicle for better view).



81. Secure pre-routed passenger side IC fitting to passenger side LTR fitting. Secure with pinch clamp. Ensure that hose cannot bind while routed through condenser lines.



82. Install the IC pump relay harness. Connect the 12V and ground eyelets to the factory positions as shown.

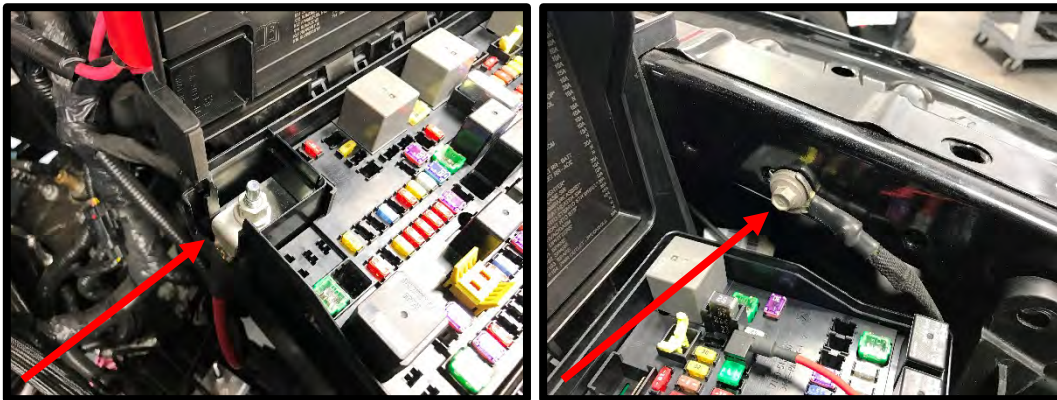

83. Route the turn on wire (orange) through the fuse box. In some cases, a notch may be required for the wire to fit through the fuse box (make sure wire cannot not be cut or chaffed). Remove the fuse from location #70 (fuel pump). Install this into the fuse tap. Install the fuse tap (should have the 30amp and 10amp fuses) into location #70. Route the pump 4-way connector to the driver side front fender for connection to the IC pump.

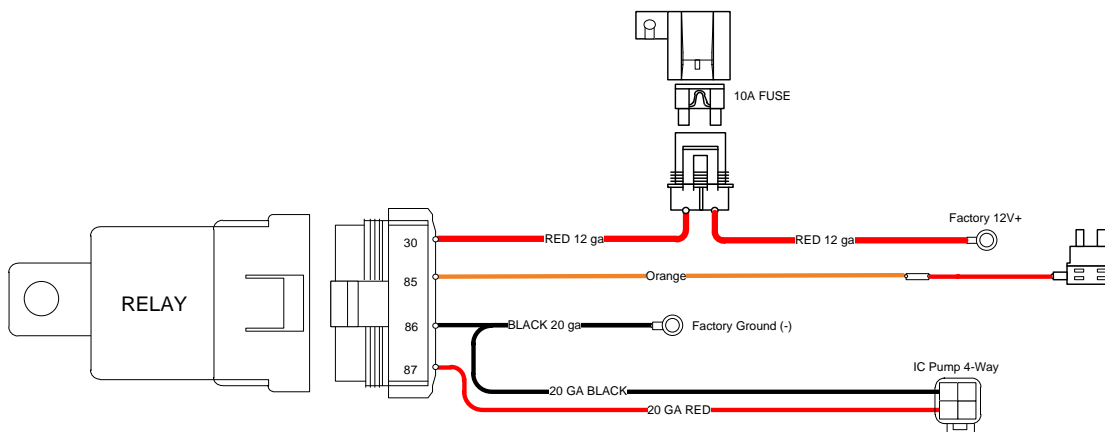

84. Install the fuel injectors to the fuel rail, reuse the factory lock clips with factory fuel rails. Billet fuel rails discard locking clips.
85. (Stock fuel rails) Install the supplied 3/8" x 17" hose to the driver side fuel rail. Apply grease or silicone to hose ends for easier installation. You may also use a heat gun on the hose prior to installing (away from any fuel vapors) to make the hose more flexible. Secure line on barb using supplied safety clamp. Leave other end off for later installation.
86. (Billet fuel rails) Install the supplied (3) 6AN plugs to the front of the fuel rails and passenger side top fitting. Install the 6AN to 9.49mm fitting into driver side top boss.

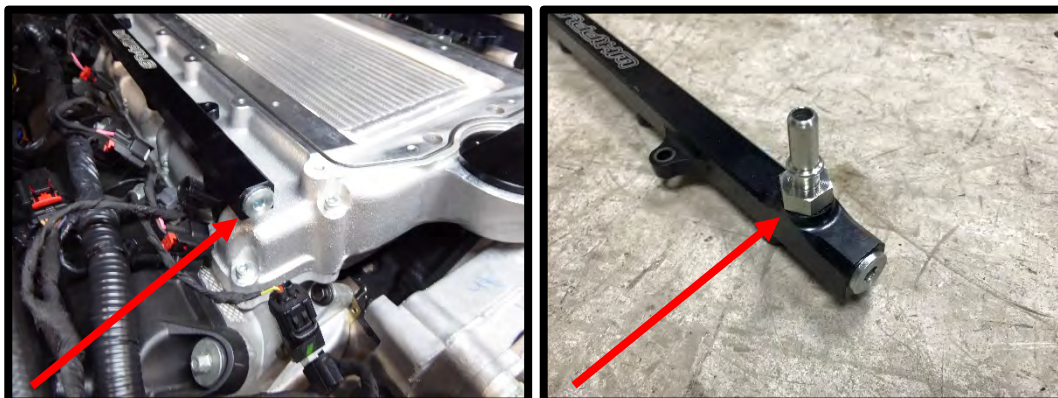

87. (Billet fuel rails) Install the injectors and rails to the intake manifold, use the (4) 15mm fuel rail spacers under the bolt bosses for proper spacing. Secure with the (4) 6mm x 35mm SHCS. Torque to 106 in-lbs.
88. (Billet fuel rails) Install supplied fuel feed line to the factory line and billet fuel rail driver side front fitting.

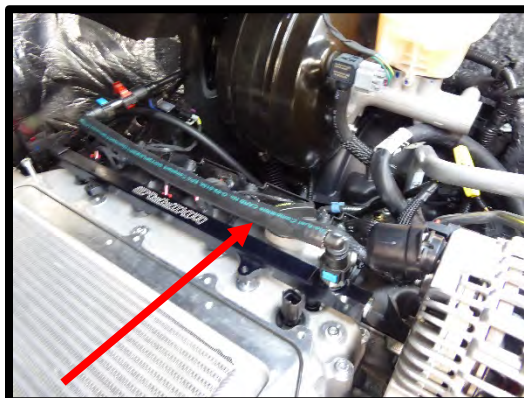

89. (Stock fuel rails) Install the fuel rail brackets to intake manifold using the supplied (4) 6mm x 16mm SHCS. Torque to 106 in-lbs.



90. (Stock fuel rails) Secure stock fuel rails to fuel rail brackets using the (4) 6mm x 12mm. Torque to 106 in-lbs.



91. (Stock fuel rails) Reconnect factory fuel feed line to fuel rail.



92. Install the supplied (3) 9.89mm to 6an oring fitting to the SC inlet.

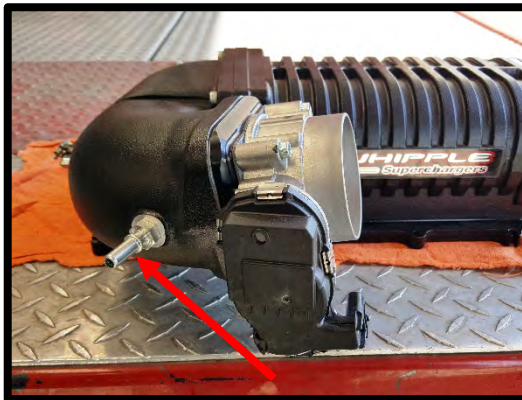
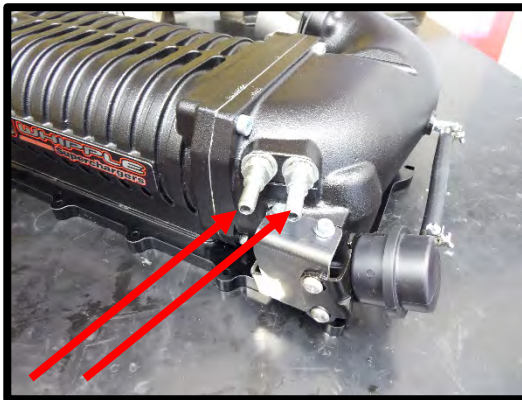

93. (Stock fuel rails) Connect other end of fuel line to the passenger side fuel rail barb. Apply grease or silicone to hose ends for easier installation. You may also use a heat gun on the hose prior to installing (away from any fuel vapors) to make the hose more flexible. Secure with safety clamp.

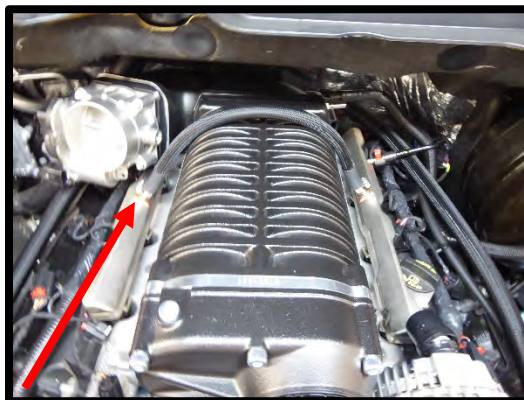

94. The supercharger must be filled with oil prior to use. This supercharger is shipped without oil inside. The oil is in a separate bottle supplied with your kit. The bottle is pre-filled to the exact amount required (5.8 fl/oz.).

CAUTION: Severe damage to the compressor will occur if you overfill the supercharger rear gear case

- Make sure the SC is sitting on a flat surface.
- Remove -6AN allen plug (1/4" allen wrench) and fill SC with **WHIPPLE SC OIL ONLY!!**
- Fill to the middle of the sight glass. NOTE: The W175AX compressor takes a minimum of 5.4 fl/oz. and a maximum of 5.8 fl/oz.
- Reinstall -6AN allen plug.
- NOTE: After running the SC, the oil level will lower due to oil filling the bearings. The proper level while **not running** should be between the bottom of the sight glass and the middle and will vary when running and not running.
- Change SC oil every 100,000 miles and only use **WHIPPLE SC OIL ONLY!!**

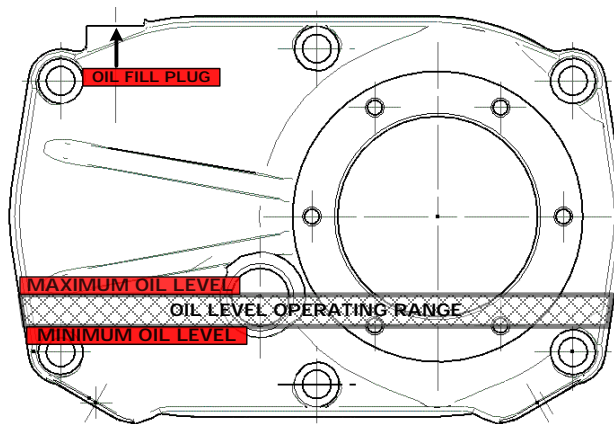

95. Carefully set the compressor assembly to the upper intake manifold. Make sure not to rip the bypass passage oring or the SC to upper manifold oring.
96. Install the supplied (9) 6mm x 22mm and (1) 6mm x 30mm SHCS into the supercharger discharge plate to upper manifold (hand tight). Using a 5mm long allen socket (ball head on passenger side) and torque wrench, torque to 106 in/lbs in the following pattern. Install the EVAP solenoid bracket to the passenger side 2nd bolt (3).

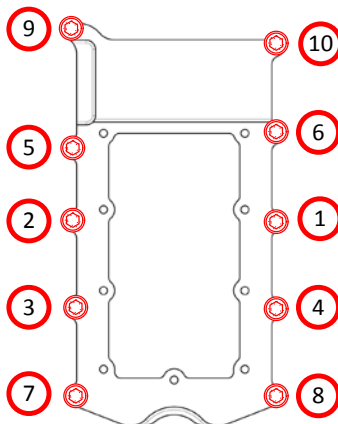

97. Mount the EVAP solenoid to the supplied adapter bracket by sliding rubber grommet over bracket.



98. Install the supplied brake booster 3/8" 90deg quick connect fitting to the end of the factory brake booster hose. Connect hose to the front driver side 9.89mm fitting.

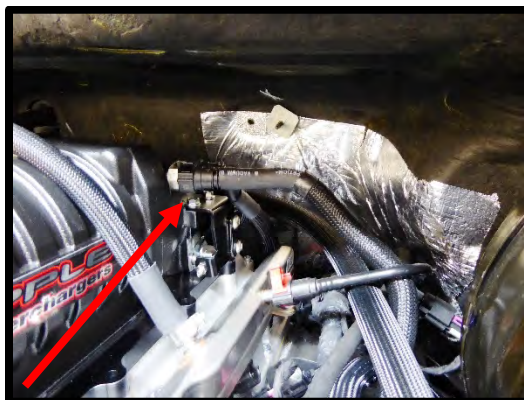

99. Install the supplied EVAP hose from the 3/8" x 40" EVAP solenoid around the back of the SC, to the driver side rear quick connect fitting.
100. Install the supplied 3/8" x 9 1/4" from the PCV to the SC inlet fitting on the passenger side. Install zip-tie around rubber 90deg on PCV valve to help secure in place.
101. Install the throttle body to the supercharger inlet using the throttle body adapter. Install the inlet gasket to the inlet, throttle body adapter, followed by the throttle body gasket and then the throttle body. Use the supplied (4) 6mm x 50mm SHCS. Using a 5mm allen and torque wrench, torque to 65 in/lbs.
102. Install the air tube with the 3 1/2" to 4" silicone hose with the supplied (4) #56 and #64 clamps.



103. (Stock air box) Connect the supplied $\frac{3}{4}$ " x 11" hose and $\frac{3}{4}$ " to $\frac{5}{8}$ " adapter to the pre-routed oil fill barb fitting. Connect hose to factory airbox.

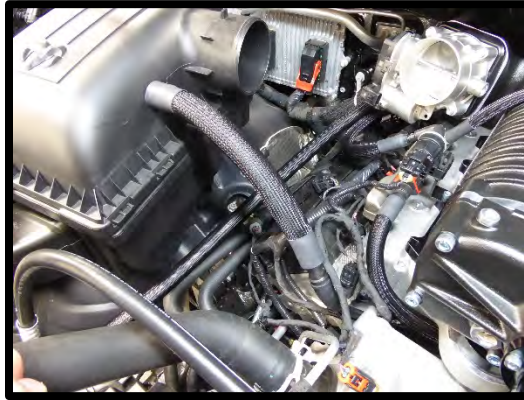

104. (Whipple CAI systems) Using a 1" drill bit, drill a hole in the boss of the air tube. Install the supplied 1" to $\frac{3}{4}$ " ID rubber grommet. Install the supplied $\frac{3}{4}$ " to $\frac{5}{8}$ " barb fitting into air tube. Connect pre-routed hose to air tube.



105. Install the supplied belt by using a $\frac{1}{2}$ " breaker bar to release tension from spring loaded tensioner. Route belt as shown in diagram. Use the adjustable idler to take any and all slack from the belt. Torque adjustable idler pulley to 22 ft-lbs. Carefully release tensioner. The tensioner should always have $\frac{3}{4}$ to full travel left once idler is adjusted. If it does not, the belt maybe too short or the adjustment is not enough. Readjust if necessary.

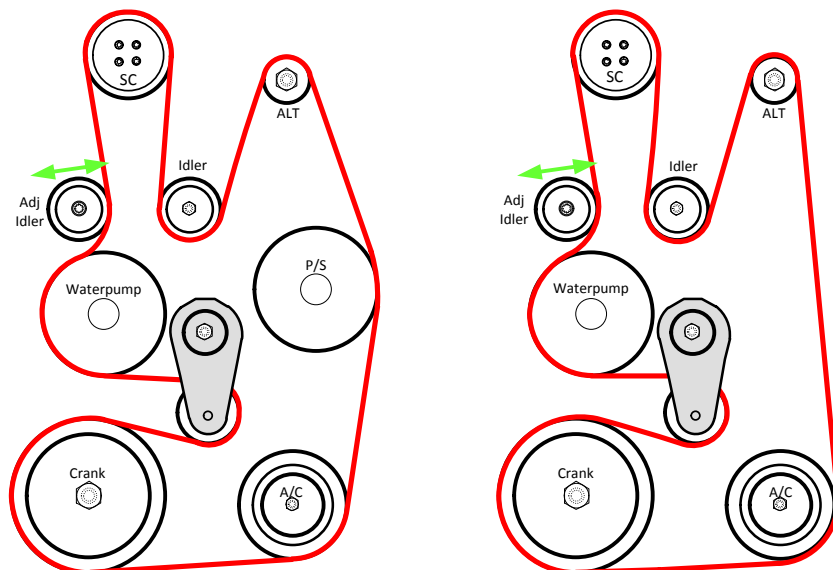

106. Reinstall the AC line plastic clamp to the new AC line support bracket. Use the supplied (1) 8mm x 30mm SHCS to secure.

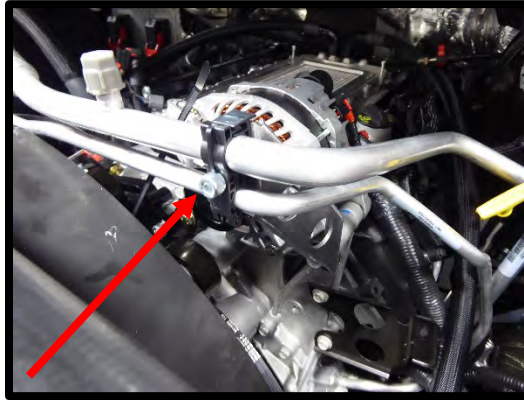

107. Refill the Engine coolant. Verify that your coolant drain is closed, use a filter/strainer to pour the recycled coolant/water mixture that you drained from the radiator. If necessary, top off with a **Dodge/Chrysler/Jeep approved engine coolant**. Whipple also recommends running 2 bottles of Redline Water Wetter which can be found at most automotive parts stores.



The electric water pump used on the Whipple SC system has a built-in micro-processor that will vary pump cycle speed when air bubbles are present in the system. If a significant amount of air is trapped in the system, the pump may cycle at a lower speed and pulsations are likely to occur resulting in poor cooling performance.

For the best result, it is highly recommended to use a Radiator Cooling System Vacuum Purge and Refill Kit to properly evacuate the air from the intercooler system before filling the 50/50 mixture of coolant and distilled water. If one is not available, the following procedure will be adequate.

108. Using a Lisle 24680 Spill-Free Funnel, or equivalent, secure the appropriate filler neck adapter to the filler neck/surge tank.
109. Attach the funnel and fill with a 50/50 mixture of coolant and distilled water until the funnel is half full. Whipple recommends Zerex G-05 to match the stock color. The Whipple IC system is compatible with all common types of antifreeze, it is customer preference. Note: Whipple also recommends 1 bottle of Red Line Water Wetter or equivalent. Never use tap water, this will cause corrosion and destroy the system.
110. Turn the ignition to the ON position and listen for the pumps electric motor to cycle. Air bubbles will begin to purge from the system as the coolant level drops. Add coolant to the funnel as necessary. Note: Do NOT let the coolant level in the funnel run empty as this may introduce air into the system.
111. To build more pressure in the intercooler system, try squeezing the intercooler hoses while the pump is cycling. Building pressure in the system will help purge the trapped air from the intercooler system. It can also help to lift the filler neck 4"-8" higher than its mount to help purge the air.
112. Cycle the ignition OFF and wait a few seconds for the pump to stop.
113. Cycle the ignition to the ON position again and repeat until the sound of the electric pump is continuous without any pulsation. *NOTE: During water pump start-up, it is normal for a slight pulsation to occur. Once the pump has reached its maximum cycle speed, no pulsations should be present.*
114. Periodically inspect the water pump flow after a few drive cycles and re-fill the intercooler system as necessary.

115. Several drive cycles may be required to completely purge the air from the intercooler system. During a drive cycle, the intercooler system will build up pressure as the supercharger temperature increases. Any residual air trapped in the system will gradually bleed out of the surge tank when the cap is removed. Use a rag when removing in case there is excess pressure. **Do not go WOT or dyno test until the system is properly relieved of air. Note: The pump will cavitate when there's air, this is a sign that it needs to be bled more.**

WARNING: Always avoid removing the filler neck cap when the system is hot. The hot coolant is under pressure and may spray out causing burns.

116. Attach the negative cable to the battery and tighten using a 10mm wrench.
117. Turn the Ignition key on DO NOT START THE ENGINE (This will turn ON the fuel pump for 2 seconds) Inspect for leaks (fuel, coolant, intercooler coolant), correct as required.
118. Before driving, make SURE that you have 91 [(RON+MON)/2] or higher octane fuel in the system. NOT ½ tank of 87 and ½ tank of 91, ALL 91 or better fuel in the system. DO NOT USE ANY OCTANE BOOSTER IN THE FUEL.
119. DO NOT use ANY aftermarket air filter box or duct with the supplied Whipple calibration. The Whipple calibration is designed to work with the stock air box or Whipple cold air intake system. Changing the panel filter is ok, although Whipple feels the stock clean unit is sufficient. Changes to the air inlet system could cause potential issues with the calibration and performance. Aftermarket throttle bodies are not supported with the Whipple calibrations.
120. Clean the inner area of the gas door with acetone. Attach the "91 OCTANE OR HIGHER" decal to the gas tank fill cap or door.



121. If you would like to install a boost gauge, there is an extra 1/8" NPT port located on the driver side of the intake manifold.

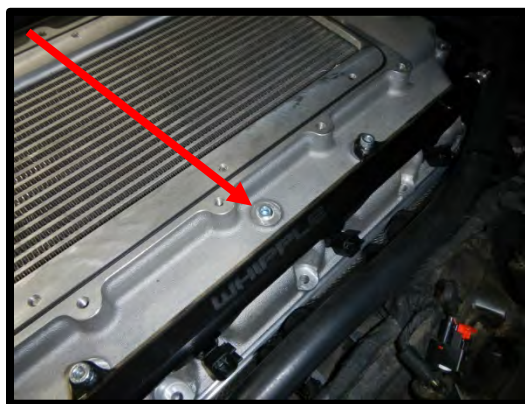

122. Test drive vehicle for the first few miles under normal driving conditions, obey all traffic laws. Listen for any noises, vibrations, engine misfire, detonation/pinging or anything that does not seem normal. The supercharger does have a slight whining noise under boost conditions, which is normal.
123. Re-check the radiator and intercooler reservoir coolant level regularly over the first 1,000 miles, top off level as needed.
124. Re-check SC oil level regularly over the first 1,000 miles, level may drop very slightly as it fills the bearings and cavities.
125. After the initial test drive, go through the belt tensioner process again. During your second test drive, gradually work the vehicle to wide open throttle runs. Listen for any engine detonation (pinging). If engine detonation is present, let up on the throttle immediately. Most detonation causes are low octane gasoline still in the tank or the wrong/old spark plugs. Fuel PSI is extremely important. 58psi is standard but the systems commonly drop to 50psi supercharged which is calibrated into the PCM cal. Fuel psi dropping below this may have a clogged fuel filter and or degraded fuel pump. If fuel psi drops below standard levels (50-58), do not operate at WOT until this is resolved.
126. If you have questions about your vehicles performance, please check with your installation facility or call Whipple Superchargers at 559.442.1261, Monday through Friday from 8am to 5:00pm, Pacific Time or email questions to tech@whipplesuperchargers.com. Whipple does not offer custom tuning for modified engines.

⚠ WARNING!! Verify the bypass actuator is working properly. To monitor, look at the bypass arm when the motor is not running. Start engine and verify that the actuator arm has opened. This arm will be extended when the engine is above 1" of vacuum (boost) and will be open when there is more than 1" of engine vacuum.

MAINTENANCE AND SERVICE

Be sure to follow the maintenance and service recommendations below to optimize the life and performance of your Whipple-supercharged vehicle.

For best performance and continued reliability, it is essential to adhere to the following guidelines:

1. When changing engine oil, remove the catch can from intake manifold for proper filling.
2. Use only premium grade fuel (91-octane or higher). (RON+MON)/2 is the US spec on fuel.
3. Always listen for any sign of spark knock or pinging. If present, discontinue use immediately and consult your vehicle owner's manual.
4. Do not operate the vehicle at large throttle opening if the MIL lamp is on steadily. This indicates an electronic engine control malfunction: reduce throttle opening and consult your vehicle dealer.
5. Check the supercharger oil level at every engine oil change. Add Whipple SC oil to the supercharger if required. Do not overfill the supercharger rear gear case.
6. Change the oil in the supercharger every 100,000 miles. Use Whipple SC approved oil only.

Severe damage to the compressor will occur if you overfill the supercharger rear gear case.

7. Do not operate the vehicle at large throttle opening if the MIL lamp is on steadily. This indicates an electronic engine control malfunction: reduce throttle opening and consult your vehicle dealer.
8. Inspect and clean your high-flow air filter element every 7,500 miles.
9. Inspect and replace spark plugs every 10,000 miles. Only run specified plugs.
10. Follow your factory service intervals for oil changes and other typical maintenance items.
11. Check the supercharger/accessory drive belt. Adjust or replace as required

!! CAUTION !!

Any modification to your vehicle's new computer program may cause serious damage to the engine and/or drive train.

IMPORTANT INFORMATION

BOOST LEVELS

All Whipple kits are shipped with boost levels that Whipple feels achieves maximum power while maintaining reliability with stock engines (@ sea level). Additional pulleys are available for lower and higher boost levels, the supplied calibration (complete kits) for the original pulley or larger (lower boost). Higher boost levels must run higher octane levels such as 100LL, 104, 110, 116, etc. or be custom tuned.

EXHAUST

Cat-back exhaust systems help reduce heat and minimize exhaust back pressure. They do not affect the calibration and are always a good idea for added safety and performance. Long tube headers and/or high flow cats require custom calibrations and are not supported by Whipple. While they make more power, they greatly affect the tuning and therefore this should be custom tuned by a reputable tuner.

FUEL SYSTEM

The Whipple fuel system (FLOW) needs no additional changes for power levels supplied by Whipple. Any smaller pulley changes, custom calibration, custom engines may require fuel system changes.

AIR FUEL RATIO

Air fuel ratio is the measurement of the amount of air and fuel being burned during the combustion process. In order for you to monitor the air fuel ratio, you must have an 18mm bung welded into the exhaust. The ideal placement is pre-catalytic converter as the catalytic converter can give false readings. While in some cases, it may not be possible to measure air fuel post-cat, one must verify that the post-cat reading is stoich at idle and should technically show .20 to .50 leaner air fuel ratio during WOT operation.

There are currently many different air fuel-monitoring systems and accuracy is not always guaranteed. Wide band oxygen sensors vary over time and deteriorate with uses of leaded gasoline and temperature. There are currently quite a few meters on the market that do the job pretty well, some good low cost a/f meter at www.aemelectronics.com, www.ngk.com, www.innovatemotorsports.com, www.fuelairspark.com, www.autometer.com, www.daytonasensors.com.

The Whipple supplied calibration has a conservative tune where WOT should be around 11.50-11.75:1 considering 91 octane fuel with 10% Ethanol. If the air fuel is showing between 11.0-11.4:1, this is ok and only a fraction richer than target. Showing leaner than 11.8:1 with 10% Ethanol 91 octane fuel can be dangerous depending on the spark curve. 93 octane allows slightly more safety range but should still never show leaner than 12:1. Whipple has found that 12.6:1 is approx. the best a/f for power but is very dangerous on pump gas. Be very careful, too lean of an air fuel ratio increase cylinder temps and increase the chance of detonation, which is detrimental to engine life.

FUEL OCTANE

Never run a fuel octane that is below 91 octane, $(RON+MON)/2$ and never run fuel with more volume than 10% Ethanol. It is recommended, when available, to run 92-94 octane. Never mix mid-level (below 91) with 91+, this is very dangerous and can cause severe engine damage. Do not attempt to increase octane ratings with generic octane boosters, these are very hard on spark plugs and many brands do very little to the actual octane rating (1 point is .1 octane). For emergency situations and racing applications, the best octane booster found to date is VP Octanium Madditive (#1 choice) and NOS "Off-road" formula. Some other brands are hard on spark plugs so constant use will require increased spark plug maintenance. The PCM constantly adapts, if it senses better fuel, it will increase power accordingly.

ENGINE COOLANT

Whipple recommends running a 50/50 mix of distilled water and coolant. The engine temp should run between 195-205deg F under normal driving conditions. The fans are turned on at an earlier temp to promote cooler operating temps. We also recommend 1-2 bottles of Red Line Water Wetter coolant additive. This will reduce air bubble insulation, which increases overall engine temp.

FUEL LEVEL

Never operate at WOT when the vehicle fuel levels are below a 1/8 tank. Low fuel levels could cause the fuel pump to cavitate and you'll have fuel flow spikes resulting in lean conditions and consequently detonation.

CONGRATULATIONS

Your new Whipple Supercharger is engineered to significantly increase your engines power across a broad range of RPM's. It is Whipple's goal to improve your driving experience for many miles and years to come.

Whipple Superchargers operate as an air pump and contain internal rotors that are driven by the engine's crankshaft and serpentine belts. The supercharger compresses outside air and channels it into the engine's intake ports. Because of their design, superchargers may generate some additional noise over the standard, normally aspirated induction system.

At idle, you may hear a medium-pitch rattle from the supercharger main housing. This will diminish at about 400-500 rpm above idle.

You may also experience a muffled high-pitched whine during acceleration. This is caused by the pumping action of the supercharger compressing air and only occurs during boost conditions. It is inaudible during part-throttle acceleration.

These are normal noises associated with any supercharger and have no effect on supercharger performance or engine durability.

Your supercharger is warranted by Whipple Superchargers, please see your terms and conditions on the back of your invoice for more information in regards to the limited warranty. NOTE: Whipple Superchargers will not authorize any warranty repair work or supercharger replacement for normal noise

INSTALLATION NOTES