

DODGE/CHRYSLER

5.7L Hemi Cars

Gen. 2 Supercharger System Installation Instructions

2009-2010 Model Years

50 State Smog Legal per CARB EO# D-213-31

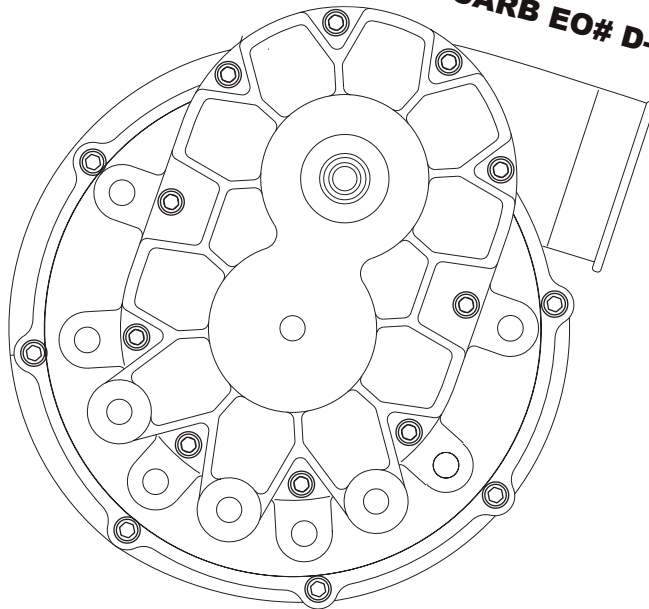

ENGINEERING, INC.

1650 PACIFIC AVENUE • CHANNEL ISLANDS, CA 93033-9901 • (805) 247-0226
FAX (805) 247-0669 • www.vortechsuperchargers.com

FOREWORD

This manual provides information on the installation, maintenance and service of the Vortech supercharger kit expressly designed for this vehicle. All information, illustrations and specifications contained herein are based on the latest product information available at the time of this publication. Changes to the manual may be made at any time without notice. Contact Vortech Engineering for any additional information regarding this kit and any of these modifications at (805) 247-0226 7:00am - 3:30pm PST.



Take note of the following before proceeding:

1. Proper installation of this supercharger kit requires general automotive mechanic knowledge and experience. Please browse through each step of this instruction manual prior to beginning the installation to determine if you should refer the job to a professional installer/technician. Please contact your dealer or Vortech Engineering for possible installers in your area.
2. **This product was designed for use on stock (*un-modified, OEM*) vehicles.** The PCM (*computer*), engine, transmission, drive axle ratios and tire O.D. must be stock. If the vehicle or engine has been modified in any way, check with Vortech prior to installation and use of this product.
3. Use only premium grade fuel with a minimum of 91 octane (*R+M/2*).
4. Always listen for any sign of detonation (*knocking/pinging*) and discontinue hard use (*no boost*) until the problem is resolved.
5. Vortech is not responsible for any clutch, transmission, drive-line or engine damage.

Exclusions from Vortech warranty coverage considerations include, but not limited to:

1. Neglect, abuse, lack of maintenance, abnormal operation or improper installation.
2. Continued operation with an impaired vehicle or sub-system.
3. The combined use of Vortech components with other modifications such as, but not limited to, exhaust headers, aftermarket camshafts, nitrous oxide, third party PCM programming or other such changes.

© 2014 VORTECH ENGINEERING, INC.

All rights reserved. No part of this publication may be reproduced, transmitted, transcribed, or translated into another language in any form, by any means without written permission of Vortech Engineering, Inc.

TABLE OF CONTENTS

FOREWORD	ii
TABLE OF CONTENTS.....	iii
IMPORTANT NOTES	iv
TOOL & SUPPLY REQUIREMENTS.....	vi
PARTS LISTS.....	vii
1. PREPARATION AND REMOVAL	1
2. FRONT FASCIA REMOVAL	2
3. HARMONIC DAMPER DOWEL PIN INSTALLATION	3
4. FUEL INJECTOR REPLACEMENT	4
5. SUPERCHARGER MOUNTING PLATE INSTALLATION	5
6. SUPERCHARGER INSTALLATION	8
7. AIR INLET INSTALLATION	9
8. CHARGE AIR COOLER / DISCHARGE ASSEMBLY INSTALLATION	11
9. RESERVOIR AND WATER PUMP ASSEMBLY AND INSTALLATION	14
10. CHARGE AIR COOLER RADIATOR INSTALLATION	15
11. FUEL PUMP VOLTAGE BOOSTER INSTALLATION	17
12. REFLASH COMPUTER	21
13. FINAL ASSEMBLY AND CHECKING	22

OFF-HIGHWAY USE

When driving vehicle on non-public roads (off-road applications such as racing/high RPM) Vortech strongly recommends reducing the factory spark plug gap down to .032”.

COPYRIGHT NOTICE

This product is protected by state common law, copyright and/or patent. All legal rights therein are reserved. The design, layout, dimensions, geometry and engineering features shown in this product are the exclusive property of Vortech Engineering, INC.. This product may not be copied or duplicated in whole or part, abstractly or fundamentally, intentionally or fortuitously, nor shall any design, dimension, or other information be incorporated into any product or apparatus without prior written consent of Vortech Engineering, Inc.

ATTENTION

BEFORE STARTING INSTALLATION, PLEASE NOTE THE FOLLOWING:

Your vehicle's ECM may need to be updated. This can be determined by locating the supplied Diablosport programmer and plugging it into the vehicle's OBD2 port.

Once the programmer is powered up and is at the main menu screen, there will be four options to choose from:

- Tune Vehicle
- Scan Tool
- Settings

Select "Tune Vehicle" and follow the screen for instructions.

If you are prompted to update the vehicle's calibration, disconnect the Diablosport programmer and follow these steps:

Tools required: Diablosport U7778 Interface Kit.

In the event you are unable to purchase or locate a U7778 Interface Kit, this process can be accomplished by using the vehicle for the power source (by plugging the programmer into the vehicle's OBD2 port) and by purchasing a USB to serial cable (RS232) (Note: if your computer has a serial cable outlet plug then just a serial cable will be needed).

If you are unable to use the vehicle as the power source, a power supply will be required.

The requirement for the power supply: Input 120 VAC 60Hz 30W output 12 VDC 1000 Ma, with a 5.5 x 2.5 mm tip, positive center.

With the programmer powered up and connected, and the main menu screen being displayed:

- Type the following into your web browser: vortechsuperchargers.com/dsinstaller
- Save the installer to your desktop. It should place an installer icon on your desktop.

- Double-click on the DS Downloader installer on the desktop to start the installation process. Follow the prompts to install.
- Once the installer has completed, locate the new icon that the installer has placed on your desktop. (See Fig)



DSDownloader

- With the programmer powered up and connected to your computer, double-click on the DSDownloader icon. You should see an option to download calibration update.
- Select the update and allow the program to connect to Diablosport's website. This may take a few minutes.
- Once the programmer has updated, disconnect it from the power source and the computer.
- Plug the programmer into the vehicle's OBD2 port and follow the main menu screen (as described in section 10).

Dodge/Chrysler Hemi Cars Installation Instructions

Congratulations on selecting the best performing and best backed automotive supercharger available today... the VORTECH® Supercharger!

Before beginning this installation, please read through this entire instruction booklet and the Street Supercharger System Owner's Manual which includes the Automotive Limited Warranties Program and the Warranty Registration form.

Vortech supercharger systems are performance improving devices. In most cases, increases in torque of 30-35% and horsepower of 35-45% can be expected with the boost levels specified by Vortech Engineering. This product is intended for use on healthy, well maintained engines. Installation on a worn-out or damaged engine is not recommended and may result in failure of the engine as well as the supercharger. **Vortech Engineering is not responsible for engine damage.**

Installation on new vehicles will not harm or adversely affect the break-in period so long as factory break-in procedures are followed.

For best performance and continued durability, please take note of the following key points:

1. Use only premium grade fuel 91 octane or higher (R+M/2).
2. The engine must have stock compression ratio.
3. If the engine has been modified in any way, check with Vortech prior to using this product.
4. Always listen for any sign of detonation (pinging) and discontinue hard use (no boost) until problem is resolved.
5. Before beginning installation, replace all spark plugs that are older than 1 year or 10,000 miles with original heat range plugs as specified by the manufacturer and reset timing to factory specifications (follow the procedures indicated within the factory repair manual and/or as indicated on the factory underhood emissions tag). **Do not use platinum spark plugs unless they are original equipment.** Change spark plugs every at least 15,000 miles and spark plug wires at least every 50,000 miles.

TOOL & SUPPLY REQUIREMENTS:

- Factory Repair Manual
- 3/8" Socket and Drive Set: SAE & Metric
- 1/2" Socket and Drive Set: SAE & Metric
- Adjustable Wrench
- Open End Wrenches: 3/8", 7/16", 1/2", 9/16"
- Flat #2 Screwdriver
- Phillips #2 Screwdriver
- Drill Motor
- 1/8", 3/16", 1/4", 27/64" Drill Bits
- 3/16" Allen Wrench
- Wire Strippers and Crimpers
- Utility Knife

If your vehicle has in excess of 15,000 miles since its last spark plug change, then you will also need:

- Spark Plug Socket
- NEW Spark Plugs

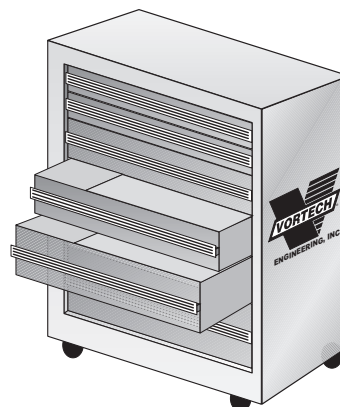



2009-2010 5.7L Manual Challenger Supercharger Kit

Part No. 4CL218-044L

PARTS LIST

IMPORTANT: Before beginning installation, verify that all parts are included in the kit. Report any shortages or damaged parts immediately.

PART NO.	DESCRIPTION	QTY	PART NO.	DESCRIPTION	QTY
008110	SMALL SILVER DIE CUT DECAL	2	7C080-100	M8 X 1.25 X 100 HXHD ZN PLT	3
008130	LICENSE PLATE FRAME, VORTECH	1	7C080-120	BOLT, 8MM X 120MM X 1.25 HXHD	1
008341	VORTECH CHARGE COOLER DECAL	1	7G010-175	12MM X 1.75 NUT	1
008447	1 YR S/C STRT INFO PKG ASY VOR	1	7J012-092	12MM WASHER, FLAT	1
009035	S/C LUBE, BOTTLED, VORT 3-PACK	1	7J312-000	5/16 FLAT WASHER-SAE	11
2A046-106	BELT PREMIUM 104.5", GATES	1	7J375-044	3/8 SAE WASHER, PLTD	4
2F329-134	V3 S/C ASY, 2011 6.4L HEMI CHA	1	7J500-002	1/2" WASHER, SPLIT LOCK	1
4CL010-160	BRKT, FLDYNE CHLLNGR DRVR	1	7U100-069	KEY, 3/16 SQUARE X .73 LONG	1
4CL010-170	BRKT, FLDYNE CHLLNGR PASS	1	7U100-073	KEY, 3/16 SQUARE X 1.375 LONG	1
4CL020-015	INSTR MAN, 09-10 5.7 HEMI CAR	1	7U100-084	SNAP RING, EXT DRV HOUSING	1
4CL110-032	FUEL SYSTEM ASSY, 5.7L HEMI	1	7X100-027	WAVE WASHER, LARGE, V2 INPUT	1
4CL010-030	MAP SENSOR BLOCK, 07 CHARGER	1	4CL110-060 ASY,P/S,09 5.7L M6 HEMI CHAL		1
4CL014-010	THERMOSTAT, 180° HEMI CAR	1	7P375-075	3/4" HOSE BARB UNION, BRASS	1
4CL145-010	ASSY, FUEL LINE, 2009 5.7L HEM	1	7R004-007	STEPLESS CLAMP, 28.6 X 7MM WID	2
5A002-017	MAP SENSOR, 07 CHARGER SC	1	7R002-010	#10 SAE TYPE F SS HOSE CLAMP	1
5A002-024	CONNECTR, MAP SNSR, 09 5.7L HE	1	7P500-078	1/2NPT X 3/4 HOSE FIT STRT	1
5A002-025	SENSOR, IAT, 2005-08 DODGE HEM	1	7P500-036	1/2 NPT, STREET, 45 DEG	1
7A250-074	1/4-20 X .75 HHCS PLTD	1	4CL010-241	FITTING, P/S, 09 5.7L M6 HEMI	1
7C010-052	10-24 X 1/2 BUTTN HEAD CRWW	2	4CL110-110* ASSY, DAMPER PIN, HEMI		1
7F250-021	1/4-20 NYLOCK NUT ZINC PLATED	1	4CL112-030* AIR INLET ASSY, HEMI		1
7J250-001	1/4 WASHER, SAE, PLTD	2	4CL112-074* AIR DISCH ASSY,HEMI CAR, G2		1
7P062-187	1/16NPT X 3/16 HOSE BARB	1	5A003-080 TUNER, ECU, DIABLOSPORT IN-TUN 1		1
7P250-045	1/4 MALE NPT X 3/8 MALE BARB	2	5A102-031 ASSY, VOLT BOOST SRT8 HEMI G3		1
7P375-113	PCV VALVE, VIPER, 3/8"-1/2" BA	1	5A002-031	VOLT BOOSTER HEMI G3	1
7P500-003	1/2"-3/8" REDUCER BARB UNION	1	5W001-021	1/2" SPLIT PLASTIC WIRE LOOM	2'
7R001-006	#6 STNLS HOSE CLAMP, NARROW	2	5W001-005	3/8" SPLIT PLASTIC WIRE LOOM	9'
7R004-002	STEPLESS CLAMP, 17.0-70	2	5W001-032	1/4" SPLIT PLASTIC WIRE LOOM	20'
7R004-687	STEPLESS CLAMP,13/16" ONE EAR	4	5W012-000	12GA. RED STRANDED WIRE	4'
7U030-053	3/8 X 90° MOLDED RUBBER HOSE	4	5W012-010	12GA. BLACK STRANDED WIRE	4'
8F060-008	FUEL INJECTOR, HEMI CHARGER	8	5W012-080	12GA. ORANGE STRANDED WIRE	8'
4CL110-054 ASSY, S/C MTG BRKT, 09 5.7L M6		1	5W014-010	14GA. RED STRANDED WIRE	8'
008725	CAP, TAMPER PROOF, VORT S/C	2	7U030-024	1/8" NYLON INSTRUMENT TUBING	21'
2A017-016	PILOT, 6203/5 BRG, 3/8 SCREW	1	7P156-082	5/32" TEE	1
2A017-093	SPACER, S/C PULLEY, .093"	1	7U030-109	7/64" VAC HOSE	.5'
2A017-105-222B	SPCR, BLK 1"OD X .328"ID X 2.225	5	7U100-044	4" NYLON TIE WRAPS	10
2A017-156	SPCR, SM IDLER, DBL BRG JACK	1	7U100-055	7.5" NYLON TIE WRAPS	10
2A017-462	SPACER, IDLER SMOOTH 6 RIB	1	5W001-014	FUSE HOLDER 10GA. WIRE	1
2A017-750-09	SPACER, .75 OD X .363 L (P/S)	2	4CL010-260	MOUNTING PLATE FPB	1
2A036-136	S/C PULLEY 3.60" 6 GROOVE W/FL	1	7C010-050	10-24 X 1/2" SCREWS	4
2A040-051	PLY RETAINER, TAMPER PRF CAP	2	7J010-001	#10 FLAT WASHER	4
2A040-061	RETAINER CUP, VORT S/C PLY	2	7F010-024	10-24 NYLOCK NUT	4
2A042-080	BELT, GATES 20MM, 80 TOOTH	1	7A250-074	1/4-20 X 3/4" HEX HEAD BOLT	2
2D070-159	LARGE BEARING,EXTENDED DRIVE	2	7J250-001	1/4" WASHER	4
2D070-171	JACKSHAFT, C5, H900, 1INCH	1	7F250-022	1/4-20 NYLOCK NUTS	2
4CL010-044B	SC, MTG, PLT, BLACK ANODIZE	1	5W001-007	3/16 HEAT SHRINK	.75'
4CL010-221B	PLATE, CYL HEAD 09-10 5.7L HEMI	1	5W001-038	1/4 HEAT SHRINK	.75'
4CL010-230	PLT, SUP, REAR, 09 5.7L M6 HEMI	1	5W001-043	10-12GA. 1/4" YELLOW RING TERMINAL	2
4CL116-350	IDLER ASSY, 20MM GILMER, SRT8	1	5W001-041	10-12GA. YELLOW SLIDE CONN MALE	2
4FD017-011	PILOT, 6203/5 BRG, 1/2 SCREW	1	5W001-040	10-12GA. YELLOW SLIDE CONN FEMALE	2
4FT017-080	SPCR, COOLER SUPPORT	1	5W001-019	10-12GA. YELLOW BUTT CONN	1
4GR032-032	PULLEY,JACKSHAFT,C5,20MM,32T	1	5W001-009	14-16GA. BLUE SLIDE CONN MALE	1
4GR116-300	IDLER ASSY, 20MM GILMER, C5	1	5W001-010	14-16GA. BLUE SLIDE CONN FEMALE	1
4HS017-041	SPACER, LOWER S/C PLT S2000	2	5W001-013	14-16GA. BLUE BUTT CONN	2
4NZ030-041	BEARING HSG, 350Z	1	8N006-020 WATER COOLR, FLDYN DUAL PASS		1
7A312-152	5/16-18 X 1.5 SHCS, ZN PLT	4	8N105-220*WATER TANK ASSY, 2011 6.4 HEMI		1
7A375-124	3/8-16 X 1-1/4 HHCS, G5, PLATE	4	8N107-190*WATER PUMP MTG ASSY, 07 CHGR		1
7A375-225	3/8-16 X 2-1/4 HXHD G8	1	8N201-394 WELDED,CORE ASSEMBLY,HEMI		1
7B375-075	3/8-24 X 3/4" GR8 HXHD BOLT	1			
7B375-150	3/8-24 X 1-1/2 GR8 HX	1			
7C012-100	12MM X 100MM X 1.75 HXHD BOLT	1			
7C080-025	M8 X 1.25 X 25 HXHD	3			
7C080-090	M8 X 1.25 X 90 HXHD CL10.9	3			

*SEE PAGE VIII FOR INDIVIDUAL COMPONENTS IN ASSEMBLY



2009-2010 5.7L Manual Challenger Supercharger Kit (cont'd)

Part No. 4CL218-044L
PARTS LIST

IMPORTANT: Before beginning installation, verify that all parts are included in the kit. Report any shortages or damaged parts immediately.

PART NO.	DESCRIPTION	QTY	PART NO.	DESCRIPTION	QTY
008110	SMALL SILVER DIE CUT DECAL	2	7P500-075	1/2NPT X 3/4 HOSE FIT STRT NIC	5
008130	LICENSE PLATE FRAME, VORTECH	1	7R007-001	NYLON RATCHET CLAMP 1-1/8"	19
008341	VORTECH CHARGE COOLER DECAL	1	7U038-000	3/4" HEATER HOSE	9'
008447	1 YR S/C STRT INFO PKG ASY VOR	1	7U038-012	HOSE, 3/4 DIA 90°, 4 X 12 LEGS	5
009035	S/C LUBE, BOTTLED, VORT 3-PACK	1	7U038-150	HOSE, 3/4 D X 150° MOLDED HOSE	1
2A046-106	BELT PREMIUM 104.5", GATES	1	7U100-044	TIE WRAP, 4" NYLON	10
2F329-134	V3 S/C ASY, 2011 6.4L HEMI CHA	1	7U100-055	TIE WRAP, 7.5" NYLON	10
4CL010-160	BRKT, FLDYNE CHLLNGR DRVR	1	8N055-030	TANK, WATER TRIANGLE SHAPE	1
4CL010-170	BRKT, FLDYNE CHLLNGR PASS	1	8N055-050	PLASTIC CAP, SURGE TANK	1
4CL010-251	BRKT, CAC SUPRT, HEMI CHALL	1	7P500-034	1/2NPT X 3/4 BARB 90°, NICKEL	2
4CL020-015	INSTR MAN, 09-10 5.7 HEMI CAR	1	7P500-035	FITTING, 1/2 NPT X 3/4 BARB X	2
4CL110-032*	FUEL SYSTEM ASSY, 5.7L HEMI	1	4CL010-290	BRKT, SURGE TANK, FILL '11 6.4	1
4CL110-054*	ASSY, S/C MTG BRKT, 09 5.7L M6	1	8N056-060	SURGE TANK, PLASTIC	1
4CL110-060*	ASY,P/S,09 5.7L M6 HEMI CHAL	1	7F375-016	3/8-16 HX NUT	1
4CL110-110	ASSY, DAMPER PIN, HEMI	1	2A017-881-01	SPACER, .875 OD X .532 LONG	1
4GR010-110	GUIDE, DWL PIN INST	1	7J375-044	3/8 SAE WASHER, PLTD	2
7C014-095	M14-1.5 X 95MM SHCS	1	7A375-350	3/8-16 X 3.5" HX HD GR5	1
7U250-019	DOWEL PIN, 1/4X1/2 +.001"	1	4CL010-280	MTG BRKT, CAC, 2011 6.4 HEMI	1
7U250-026	DRILL BUSHING, 1/4 ID, 3/8 OD, 1/2L	1	4CL010-160	BRKT, FLDYNE CHALLENGER DR	1
4CL112-074	AIR DISCH ASSY,HEMI CAR, G2	1	4CL010-170	BRKT, FLDYNE CHALLENGER PA	1
4CL010-310	DISCHARGE DUCT SUPPORT	1	8N107-190 WATER PUMP MTG ASSY, 07 CHGR	1	
4CL012-074	DISCHARGE DUCT "A" COATED	1	5W001-011	16-14 GA RING TERM .26" HOLE	1
4CL012-084	DISCHARGE DUCT "B" COATED	1	5W001-013	14-16 GA BUTT CONN BLU INSUL	2
4CL012-104	DISCH TUBE "C", 2009 5.7L HEMI	1	5W001-024	MINI ATC FUSE TAP	1
7PS275-100	SLEEVE, BLACK, 2.750D X 1.00	1	5W001-025	FEMALE SLIDE,INSULATED,MINI	1
7PS275-300	SLEEVE, BLACK, 2.75D X 3.0	4	5W001-054	18 GA FUSE HOLDER	1
7PS350-279	ELBOW, SIL 3.5X2.75 90°, BLK	1	5W014-030	14GA STRD WIRE BLACK	5
7R002-016	#16 SAE TYPE F SS HOSE CLAMP	2	7R003-027	ADEL CLAMP,1-11/16"	1
7R002-044	#44 SAE TYPE F SS HOSE CLAMP	10	8F001-402	PUMP, WATER, PIERBURG	1
7R002-056	#56 SAE TYPE F SS HOSE CLAMP	1	8N100-001	NYLON MOUNTING KIT	1
7U030-046	5/32" VACUUM LINE	5'	8N201-394 WELDED,CORE ASSEMBLY,HEMI	1	
7U034-016	1" GS HEATER HOSE	25			
8D001-004	COMPRESS BYPASS VALVE, G2	1			
8H040-075	FILTER, 1" BYPASS VALVE	1			
4CL112-030	AIR INLET ASSY, HEMI	1			
4CL010-180	BRKT, CHALLENGER AIR INLET	1			
4CL012-030	DUCT, INLET 08 HEMI CHALLENGER	1			
7A250-039	1/4-20 X 3/8" SHCS ZINC PLTD	2			
7J250-001	1/4 WASHER, SAE, PLTD	2			
7R002-056	#56 SAE TYPE F SS HOSE CLAMP	1			
7R002-080	#80 SAE TYPE F SS HOSE CLAMP	1			
7S500-351	INLET SLEEVE, HEMI, 5 X 3.5	1			
8H040-235	AIR FILTER, 4" FLG X 7.0L	1			
7P500-009	1/2"X90 HOSE BARB UNION	1			
7U030-036	1/2" OIL DRAIN HOSE	4'			
8H040-300	AIR FILTER 300C	1			
7U032-020	3/8 P/S HOSE	32"			
5A003-080	TUNER, ECU, DIABLOSPORT IN-TUN	1			
5A102-031*	ASSY, VOLT BOOST SRT8 HEMI G3	1			
8N006-020	WATER COOLR, FLDYN DUAL PASS	1			
8N105-220	WATER TANK ASSY, 2011 6.4 HEMI	1			
4CL010-190	BRKT, CAC TANK, HEMI	1			
7A250-050	1/4-20 X .50 SHCS GR8 ZINC PLT	4			
7A250-051	1/4-20 X .50 HHCS GR5 ZINC PLT	2			
7A250-101	1/4-20 X 1 HHCS ZINC PLTD	1			
7E010-075	#12 X 3/4" SHT METL SCRW HEX	8			
7J250-001	1/4 WASHER, SAE, PLTD	7			
7P375-075	3/4" HOSE BARB UNION, BRASS	5			
7P500-026	1/2NPT X 3/4 BARB 90° BRASS	2			

*SEE PAGE VII FOR INDIVIDUAL COMPONENTS IN ASSEMBLY



ENGINEERING, INC.

2009-2010 5.7L Manual Challenger Tuner Kit

Part No. 4CL218-144L

PARTS LIST

IMPORTANT: Before beginning installation, verify that all parts are included in the kit. Report any shortages or damaged parts immediately.

PART NO.	DESCRIPTION	QTY	PART NO.	DESCRIPTION	QTY
008110	SMALL SILVER DIE CUT DECAL	2	4CL110-110*	ASSY, DAMPER PIN, HEMI	1
008130	LICENSE PLATE FRAME, VORTECH	1	4CL112-074*	AIR DISCH ASSY,HEMI CAR, G2	1
008341	VORTECH CHARGE COOLER DECAL	1	4CL112-030*	AIR INLET ASSY, HEMI	1
008447	1 YR S/C STRT INFO PKG ASY VOR	1	8N006-020	WATER COOLR, FLDYN DUAL PASS	1
009035	S/C LUBE, BOTTLED, VORT 3-PACK	1	8N105-220*	WATER TANK ASSY, 2011 6.4 HEMI	1
2A046-106	BELT PREMIUM 104.5", GATES	1	8N107-190*	WATER PUMP MTG ASSY, 07 CHGR	1
2F329-134	V3 S/C ASY, 2011 6.4L HEMI CHA	1	8N201-394	WELDED,CORE ASSEMBLY,HEMI	1
4CL010-160	BRKT, FLDYNE CHLLNGR DRVR	1			
4CL010-170	BRKT, FLDYNE CHLLNGR PASS	1			
4CL010-251	BRKT, CAC SUPRT, HEMI CHALL	1			
4CL020-015	INSTR MAN, 09-10 5.7 HEMI CAR	1			
4CL110-054	ASSY, S/C MTG BRKT, 09 5.7L M6	1			
008725	CAP, TAMPER PROOF, VORT S/C	2			
2A017-016	PILOT, 6203/5 BRG, 3/8 SCREW	1			
2A017-093	SPACER, S/C PULLEY, .093"	1			
2A017-105-222B	SPCR, BLK 1"OD X .328"ID X 2.225	5			
2A017-156	SPCR, SM IDLER, DBL BRG JACK	1			
2A017-462	SPACER, IDLER SMOOTH 6 RIB	1			
2A017-750-09	SPACER, .75 OD X .363 L (P/S)	2			
2A036-136	S/C PULLEY 3.60" 6 GROOVE W/FL	1			
2A040-051	PLY RETAINER, TAMPER PRF CAP	2			
2A040-061	RETAINER CUP, VORT S/C PLY	2			
2A042-080	BELT, GATES 20MM, 80 TOOTH	1			
2D070-159	LARGE BEARING,EXTENDED DRIVE	2			
2D070-171	JACKSHAFT, C5, H900, 1INCH	1			
4CL010-044B	SC, MTG, PLT, BLACK ANODIZE	1			
4CL010-221B	PLATE, CYL HEAD 09-10 5.7L HEMI	1			
4CL010-230	PLT, SUP, REAR, 09 5.7L M6 HEMI	1			
4CL116-350	IDLER ASSY, 20MM GILMER, SRT8	1			
4FD017-011	PILOT, 6203/5 BRG, 1/2 SCREW	1			
4FT017-080	SPCR, COOLER SUPPORT	1			
4GR032-032	PULLEY,JACKSHAFT,C5,20MM,32T	1			
4GR116-300	IDLER ASSY, 20MM GILMER, C5	1			
4HS017-041	SPACER, LOWER S/C PLT S2000	2			
4NZ030-041	BEARING HSG, 350Z	1			
7A312-152	5/16-18 X 1.5 SHCS, ZN PLT	4			
7A375-124	3/8-16 X 1-1/4 HHCS, G5, PLATE	4			
7A375-225	3/8-16 X 2-1/4 HXHD G8	1			
7B375-075	3/8-24 X 3/4" GR8 HXHD BOLT	1			
7B375-150	3/8-24 X 1-1/2 GR8 HX	1			
7C012-100	12MM X 100MM X 1.75 HXHD BOLT	1			
7C080-025	M8 X 1.25 X 25 HXHD	3			
7C080-090	M8 X 1.25 X 90 HXHD CL10.9	3			
7C080-100	M8 X 1.25 X 100 HXHD ZN PLT	3			
7C080-120	BOLT, 8MM X 120MM X 1.25 HXHD	1			
7G010-175	12MM X 1.75 NUT	1			
7J012-092	12MM WASHER, FLAT	1			
7J312-000	5/16 FLAT WASHER-SAE	11			
7J375-044	3/8 SAE WASHER, PLTD	4			
7J500-002	1/2" WASHER, SPLIT LOCK	1			
7U100-069	KEY, 3/16 SQUARE X .73 LONG	1			
7U100-073	KEY, 3/16 SQUARE X 1.375 LONG	1			
7U100-084	SNAP RING, EXT DRV HOUSING	1			
7X100-027	WAVE WASHER, LARGE, V2 INPUT	1			
4CL110-060	ASY,P/S,09 5.7L M6 HEMI CHAL	1			
7P375-075	3/4" HOSE BARB UNION, BRASS	1			
7R004-007	STEPLESS CLAMP, 28.6 X 7MM WID	2			
7R002-010	#10 SAE TYPE F SS HOSE CLAMP	1			
7P500-078	1/2NPT X 3/4 HOSE FIT STRT	1			
7P500-036	1/2 NPT, STREET, 45 DEG	1			
4CL010-241	FITTING, P/S, 09 5.7L M6 HEMI	1			

*SEE PAGE X FOR INDIVIDUAL COMPONENTS IN ASSEMBLY



2009-2010 5.7L Manual Challenger Tuner Kit (cont'd) Part No. 4CL218-144L **PARTS LIST**

IMPORTANT: Before beginning installation, verify that all parts are included in the kit. Report any shortages or damaged parts immediately.

PART NO.	DESCRIPTION	QTY	PART NO.	DESCRIPTION	QTY
008110	SMALL SILVER DIE CUT DECAL	2	7U038-150	HOSE, 3/4 D X 150° MOLDED HOSE	1
008130	LICENSE PLATE FRAME, VORTECH	1	7U100-044	TIE WRAP, 4" NYLON	10
008341	VORTECH CHARGE COOLER DECAL	1	7U100-055	TIE WRAP, 7.5" NYLON	10
008447	1 YR S/C STRT INFO PKG ASY VOR	1	8N055-030	TANK, WATER TRIANGLE SHAPE	1
009035	S/C LUBE, BOTTLED, VORT 3-PACK	1	8N055-050	PLASTIC CAP, SURGE TANK	1
2A046-106	BELT PREMIUM 104.5", GATES	1	7P500-034	1/2NPT X 3/4 BARB 90°, NICKEL	2
2F329-134	V3 S/C ASY, 2011 6.4L HEMI CHA	1	7P500-035	FITTING, 1/2 NPT X 3/4 BARB X	2
4CL010-160	BRKT, FLDYNE CHLLNGR DRVR	1	4CL010-290	BRKT, SURGE TANK, FILL '11 6.4	1
4CL010-170	BRKT, FLDYNE CHLLNGR PASS	1	8N056-060	SURGE TANK, PLASTIC	1
4CL010-251	BRKT, CAC SUPRT, HEMI CHALL	1	7F375-016	3/8-16 HX NUT	1
4CL020-015	INSTR MAN, 09-10 5.7 HEMI CAR	1	2A017-881-01	SPACER, .875 OD X .532 LONG	1
4CL110-054*	ASSY, S/C MTG BRKT, 09 5.7L M6	1	7J375-044	3/8 SAE WASHER, PLTD	2
4CL110-060*	ASY,P/S,09 5.7L M6 HEMI CHAL	1	7A375-350	3/8-16 X 3.5" HX HD GR5	1
4CL110-110	ASSY, DAMPER PIN, HEMI	1	4CL010-280	MTG BRKT, CAC, 2011 6.4 HEMI	1
4GR010-110	GUIDE, DWL PIN INST	1	4CL010-160	BRKT, FLDYNE CHALLENGER DR	1
7C014-095	M14-1.5 X 95MM SHCS	1	4CL010-170	BRKT, FLDYNE CHALLENGER PA	1
7U250-019	DOWEL PIN, 1/4X1/2 +.001"	1			
7U250-026	DRILL BUSHING, 1/4 ID, 3/8 OD, 1/2L	1			
4CL112-074	AIR DISCH ASSY,HEMI CAR, G2	1	8N107-190 WATER PUMP MTG ASSY, 07 CHGR	1	
4CL010-310	DISCHARGE DUCT SUPPORT	1	5W001-011	16-14 GA RING TERM .26" HOLE	1
4CL012-074	DISCHARGE DUCT "A" COATED	1	5W001-013	14-16 GA BUTT CONN BLU INSUL	2
4CL012-084	DISCHARGE DUCT "B" COATED	1	5W001-024	MINI ATC FUSE TAP	1
4CL012-104	DISCH TUBE "C", 2009 5.7L HEMI	1	5W001-025	FEMALE SLIDE,INSULATED,MINI	1
7PS275-100	SLEEVE, BLACK, 2.750D X 1.00	1	5W001-054	18 GA FUSE HOLDER	1
7PS275-300	SLEEVE, BLACK, 2.75D X 3.0	4	5W014-030	14GA STRD WIRE BLACK	5
7PS350-279	ELBOW, SIL 3.5X2.75 90°, BLK	1	7R003-027	ADEL CLAMP,1-11/16"	1
7R002-016	#16 SAE TYPE F SS HOSE CLAMP	2	8F001-402	PUMP, WATER, PIERBURG	1
7R002-044	#44 SAE TYPE F SS HOSE CLAMP	10	8N100-001	NYLON MOUNTING KIT	1
7R002-056	#56 SAE TYPE F SS HOSE CLAMP	1			
7U030-046	5/32" VACUUM LINE	5'	8N201-394 WELDED,CORE ASSEMBLY,HEMI	1	
7U034-016	1" GS HEATER HOSE	.25			
8D001-004	COMPRESS BYPASS VALVE, G2	1			
8H040-075	FILTER, 1" BYPASS VALVE	1			
4CL112-030	AIR INLET ASSY, HEMI	1			
4CL010-180	BRKT, CHALLENGER AIR INLET	1			
4CL012-030	DUCT, INLET 08 HEMI CHALLENGER	1			
7A250-039	1/4-20 X 3/8" SHCS ZINC PLTD	2			
7J250-001	1/4 WASHER, SAE, PLTD	2			
7R002-056	#56 SAE TYPE F SS HOSE CLAMP	1			
7R002-080	#80 SAE TYPE F SS HOSE CLAMP	1			
7S500-351	INLET SLEEVE, HEMI, 5 X 3.5	1			
8H040-235	AIR FILTER, 4" FLG X 7.0L	1			
7P500-009	1/2"X90 HOSE BARB UNION	1			
7U030-036	1/2" OIL DRAIN HOSE	4'			
8H040-300	AIR FILTER 300C	1			
7U032-020	3/8 P/S HOSE	32"			
8N006-020	WATER COOLR, FLDYN DUAL PASS	1			
8N105-220	WATER TANK ASSY, 2011 6.4 HEMI	1			
4CL010-190	BRKT, CAC TANK, HEMI	1			
7A250-050	1/4-20 X .50 SHCS GR8 ZINC PLT	4			
7A250-051	1/4-20 X .50 HHCS GR5 ZINC PLT	2			
7A250-101	1/4-20 X 1 HHCS ZINC PLTD	1			
7E010-075	#12 X 3/4" SHT METL SCRW HEX	8			
7J250-001	1/4 WASHER, SAE, PLTD	7			
7P375-075	3/4" HOSE BARB UNION, BRASS	5			
7P500-026	1/2NPT X 3/4 BARB 90° BRASS	2			
7P500-075	1/2NPT X 3/4 HOSE FIT STRT NIC	5			
7R007-001	NYLON RATCHET CLAMP 1-1/8"	19			
7U038-000	3/4" HEATER HOSE	9'			
7U038-012	HOSE, 3/4 DIA 90°, 4 X 12 LEGS	5			

*SEE PAGE IX FOR INDIVIDUAL COMPONENTS IN ASSEMBLY



2009-2010 5.7L Automatic Challenger Supercharger Kit

Part No. 4CL218-054L

PARTS LIST

ENGINEERING, INC.

IMPORTANT: Before beginning installation, verify that all parts are included in the kit. Report any shortages or damaged parts immediately.

PART NO.	DESCRIPTION	QTY	PART NO.	DESCRIPTION	QTY
008110	SMALL SILVER DIE CUT DECAL	2	7B375-075	3/8-24 X 3/4" GR8 HXHD BOLT	1
008130	LICENSE PLATE FRAME, VORTECH	1	7B375-150	3/8-24 X 1-1/2 GR8 HX	1
008341	VORTECH CHARGE COOLER DECAL	1	7C012-100	12MM X 100MM X 1.75 HXHD BOLT	1
008447	1 YR S/C STRT INFO PKG ASY VOR	1	7C080-066	M8 X 1.25 X 65 HXHD CL10.9	1
009035	S/C LUBE, BOTTLED, VORT 3-PACK	1	7C080-090	M8 X 1.25 X 90 HXHD CL10.9	3
2A046-106	BELT PREMIUM 104.5", GATES	1	7C080-100	M8 X 1.25 X 100 HXHD ZN PLT	3
2F329-134	V3 S/C ASY, 2011 6.4L HEMI CHA	1	7C080-120	BOLT, 8MM X 120MM X 1.25 HXHD	1
4CL010-160	BRKT, FLDYNE CHLLNGR DRVR	1	7G010-175	12MM X 1.75 NUT	1
4CL010-170	BRKT, FLDYNE CHLLNGR PASS	1	7J012-092	12MM WASHER, FLAT	1
4CL020-015	INSTR MAN, 09-10 5.7 HEMI CAR	1	7J312-000	5/16 FLAT WASHER-SAE	11
4CL110-032	FUEL SYSTEM ASSY, 5.7L HEMI	1	7J375-044	3/8 SAE WASHER, PLTD	4
4CL010-030	MAP SENSOR BLOCK, 07 CHARGER	1	7J500-002	1/2" WASHER, SPLIT LOCK	1
4CL014-010	THERMOSTAT, 180° HEMI CAR	1	7K250-001	1/4" AN WASHER	6
4CL145-010	ASSY, FUEL LINE, 2009 5.7L HEM	1	7U100-069	KEY, 3/16 SQUARE X .73 LONG	1
5A002-017	MAP SENSOR, 07 CHARGER SC	1	7U100-073	KEY, 3/16 SQUARE X 1.375 LONG	1
5A002-024	CONNECTR, MAP SNSR, 09 5.7L HE	1	7U100-084	SNAP RING, EXT DRV HOUSING	1
5A002-025	SENSOR, IAT, 2005-08 DODGE HEM	1	7X100-027	WAVE WASHER, LARGE, V2 INPUT	1
7A250-074	1/4-20 X .75 HHCS PLTD	1	4CL110-110*	ASSY, DAMPER PIN, HEMI	1
7C010-052	10-24 X 1/2 BUTTN HEAD CRWW	2	4CL112-074*	AIR DISCH ASSY,HEMI CAR, G2	1
7F250-021	1/4-20 NYLOCK NUT ZINC PLATED	1	4CL112-030*	AIR INLET ASSY, HEMI CHAL	1
7J250-001	1/4 WASHER, SAE, PLTD	2	5A003-080	TUNER, ECU, DIABLOSPORT IN-TUN	1
7P062-187	1/16NPT X 3/16 HOSE BARB	1	5A102-031	ASSY, VOLT BOOST SRT8 HEMI G3	1
7P250-045	1/4 MALE NPT X 3/8 MALE BARB	2	5A002-031	VOLT BOOSTER HEMI G3	1
7P375-113	PCV VALVE, VIPER, 3/8"-1/2" BA	1	5W001-021	1/2" SPLIT PLASTIC WIRE LOOM	2'
7P500-003	1/2"-3/8" REDUCER BARB UNION	1	5W001-005	3/8" SPLIT PLASTIC WIRE LOOM	9'
7R001-006	#6 STNLS HOSE CLAMP, NARROW	2	5W001-032	1/4" SPLIT PLASTIC WIRE LOOM	20'
7R004-002	STEPLESS CLAMP, 17.0-70	2	5W012-000	12GA. RED STRANDED WIRE	4'
7R004-687	STEPLESS CLAMP,13/16" ONE EAR	4	5W012-010	12GA. BLACK STRANDED WIRE	4'
7U030-053	3/8 X 90° MOLDED RUBBER HOSE	1	5W012-080	12GA. ORANGE STRANDED WIRE	8'
8F060-008	FUEL INJECTOR, HEMI CHARGER	8	5W014-010	14GA. RED STRANDED WIRE	8'
4CL110-074	ASSY, S/C MTG BRKT,09-10 5.7L	1	7U030-024	1/8" NYLON INSTRUMENT TUBING	21'
008725	CAP, TAMPER PROOF, VORT S/C	2	7P156-082	5/32" TEE	1
2A017-016	PILOT, 6203/5 BRG, 3/8 SCREW	1	7U030-109	7/64" VAC HOSE	.5'
2A017-093	SPACER, S/C PULLEY, .093"	1	7U100-044	4" NYLON TIE WRAPS	10
2A017-105-222B	SPCR, BLK 1"OD X .328"ID X 2.225	5	7U100-055	7.5" NYLON TIE WRAPS	10
2A017-462	SPACER, IDLER SMOOTH 6RIB	1	5W001-014	FUSE HOLDER 10GA. WIRE	1
2A017-156	SPCR, SM IDLER, DBL BRG JACK	1	4CL010-260	MOUNTING PLATE FPB	1
2A017-876-12	SPACER, .875 OD X .475 LONG	2	7C010-050	10-24 X 1/2" SCREWS	4
2A036-136	S/C PULLEY 3.60" 6 GROOVE W/FL	1	7J010-001	#10 FLAT WASHER	4
2A040-051	PLY RETAINER, TAMPER PRF CAP	2	7F010-024	10-24 NYLOCK NUT	4
2A040-061	RETAINER CUP, VORT S/C PLY	2	7A250-074	1/4-20 X 3/4" HEX HEAD BOLT	2
2A042-080	BELT, GATES 20MM, 80 TOOTH	1	7J250-001	1/4" WASHER	4
2D070-159	LARGE BEARING, EXTENDED DRIVE	2	7F250-022	1/4-20 NYLOCK NUTS	2
2D070-171	JACKSHAFT, C5, H900, 1INCH	1	5W001-007	3/16 HEAT SHRINK	.75'
4CL010-010	BRK, PWR STR MTG, 07 CHRGR	1	5W001-038	1/4 HEAT SHRINK	.75'
4CL010-020B	PLATE, HEAD, MTG, BLK ANODIZE	1	5W001-043	10-12GA. 1/4" YELLOW RING TERMINAL	2
4CL010-044B	SC, MTG, PLT, BLACK ANODIZE	1	5W001-041	10-12GA. YELLOW SLIDE CONN MALE	2
4CL010-200	BRKT, 6.1L HEMI CAR CLR SPT	2	5W001-040	10-12GA. YELLOW SLIDE CONN FEMALE	2
4CL010-050	BRKT, 5.7L HEMI CAR CLR SPT	2	5W001-019	10-12GA. YELLOW BUTT CONN	1
4CL016-011	HUB, PWR STR PLY, HEMI CAR	1	5W001-009	14-16GA. BLUE SLIDE CONN MALE	1
4CL016-021	PULLEY, PWR STR, HEMI CAR	1	5W001-010	14-16GA. BLUE SLIDE CONN FEMALE	1
4CL116-350	IDLER ASSY, 20MM GILMER, SRT8	1	5W001-013	14-16GA. BLUE BUTT CONN	2
4FD017-011	PILOT, 6203/5 BRG, 1/2 SCREW	1	8N006-020	WATER COOLR, FLDYN DUAL PASS	1
4FT017-080	SPCR, COOLER SUPPORT	1	8N105-220*	WATER TANK ASSY, 2011 6.4 HEMI	1
4GR032-032	PULLEY, JACKSHAFT, C5, 20MM, 32T	1	8N107-190*	WATER PUMP MTG ASSY, 07 CHGR	1
4GR116-300	IDLER ASSY, 20MM GILMER, C5	1	8N201-394	WELDED, CORE ASSEMBLY, HEMI	1
4HS017-041	SPACER, LOWER S/C PLT S2000	2			
4NZ030-041	BEARING HSG, 350Z	1			
7A250-075	1/4-20 X .75 SHCS PLTD	6			
7A312-152	5/16-18 X 1.5 SHCS, ZN PLT	4			
7A375-124	3/8-16 X 1-1/4 HHCS, G5, PLATE	4			
7A375-225	3/8-16 X 2-1/4 HXHD G8	1			

*SEE PAGE XII FOR INDIVIDUAL COMPONENTS IN ASSEMBLY



2009-2010 5.7L Automatic Challenger Supercharger Kit (cont'd)

Part No. 4CL218-054L
PARTS LIST

IMPORTANT: Before beginning installation, verify that all parts are included in the kit. Report any shortages or damaged parts immediately.

PART NO.	DESCRIPTION	QTY	PART NO.	DESCRIPTION	QTY
008110	SMALL SILVER DIE CUT DECAL	2	7U038-012	HOSE, 3/4 DIA 90°, 4 X 12 LEGS	5
008130	LICENSE PLATE FRAME, VORTECH	1	7U038-150	HOSE, 3/4 D X 150° MOLDED HOSE	1
008341	VORTECH CHARGE COOLER DECAL	1	7U100-044	TIE WRAP, 4" NYLON	10
008447	1 YR S/C STRT INFO PKG ASY VOR	1	7U100-055	TIE WRAP, 7.5" NYLON	10
009035	S/C LUBE, BOTTLED, VORT 3-PACK	1	8N055-030	TANK, WATER TRIANGLE SHAPE	1
2A046-106	BELT PREMIUM 104.5", GATES	1	8N055-050	PLASTIC CAP, SURGE TANK	1
2F329-134	V3 S/C ASY, 2011 6.4L HEMI CHA	1	7P500-034	1/2NPT X 3/4 BARB 90°, NICKEL	2
4CL010-160	BRKT, FLDYNE CHLLNGR DRVR	1	7P500-035	FITTING, 1/2 NPT X 3/4 BARB X	2
4CL010-170	BRKT, FLDYNE CHLLNGR PASS	1	4CL010-290	BRKT, SURGE TANK, FILL '11 6.4	1
4CL020-015	INSTR MAN, 09-10 5.7 HEMI CAR	1	8N056-060	SURGE TANK, PLASTIC	1
4CL110-032*	FUEL SYSTEM ASSY, 5.7L HEMI	1	7F375-016	3/8-16 HX NUT	1
4CL110-074*	ASSY, S/C MTG BRKT,09-10 5.7L	1	2A017-881-01	SPACER, .875 OD X .532 LONG	1
4CL110-110	ASSY, DAMPER PIN, HEMI	1	7J375-044	3/8 SAE WASHER, PLTD	2
4GR010-110	GUIDE, DWL PIN INST	1	7A375-350	3/8-16 X 3.5" HX HD GR5	1
7C014-095	M14-1.5 X 95MM SHCS	1	4CL010-280	MTG BRKT, CAC, 2011 6.4 HEMI	1
7U250-019	DOWEL PIN, 1/4X1/2 +.001"	1	4CL010-160	BRKT, FLDYNE CHALLENGER DR	1
7U250-026	DRILL BUSHING, 1/4 ID, 3/8 OD, 1/2L	1	4CL010-170	BRKT, FLDYNE CHALLENGER PA	1
4CL112-074	AIR DISCH ASSY,HEMI CAR, G2	1	8N107-190	WATER PUMP MTG ASSY, 07 CHGR	1
4CL010-310	DISCHARGE DUCT SUPPORT	1	5W001-011	16-14 GA RING TERM .26" HOLE	1
4CL012-074	DISCHARGE DUCT "A" COATED	1	5W001-013	14-16 GA BUTT CONN BLU INSUL	2
4CL012-084	DISCHARGE DUCT "B" COATED	1	5W001-024	MINI ATC FUSE TAP	1
4CL012-104	DISCH TUBE "C", 2009 5.7L HEMI	1	5W001-025	FEMALE SLIDE,INSULATED,MINI	1
7PS275-100	SLEEVE, BLACK, 2.750D X 1.00	1	5W001-054	18 GA FUSE HOLDER	1
7PS275-300	SLEEVE, BLACK, 2.75D X 3.0	4	5W014-030	14GA STRD WIRE BLACK	5
7PS350-279	ELBOW, SIL 3.5X2.75 90°, BLK	1	7R003-027	ADEL CLAMP,1-11/16"	1
7R002-016	#16 SAE TYPE F SS HOSE CLAMP	2	8F001-402	PUMP, WATER, PIERBURG	1
7R002-044	#44 SAE TYPE F SS HOSE CLAMP	10	8N100-001	NYLON MOUNTING KIT	1
7R002-056	#56 SAE TYPE F SS HOSE CLAMP	1	8N201-394	WELDED,CORE ASSEMBLY,HEMI	1
7U030-046	5/32" VACUUM LINE	5'			
7U034-016	1" GS HEATER HOSE	.25			
8D001-004	COMPRESS BYPASS VALVE, G2	1			
8H040-075	FILTER, 1" BYPASS VALVE	1			
4CL112-030	AIR INLET ASSY, HEMI CHAL	1			
4CL010-180	BRKT, CHALLENGER AIR INLET	1			
4CL012-030	DUCT, INLET 08 HEMI CHALLENGER	1			
7A250-039	1/4-20 X 3/8" SHCS ZINC PLTD	2			
7J250-001	1/4 WASHER, SAE, PLTD	2			
7R002-056	#56 SAE TYPE F SS HOSE CLAMP	1			
7R002-080	#80 SAE TYPE F SS HOSE CLAMP	1			
7S500-351	INLET SLEEVE, HEMI, 5 X 3.5	1			
8H040-235	AIR FILTER, 4" FLG X 7.0L	1			
7P500-009	1/2"X90 HOSE BARB UNION	1			
7U030-036	1/2" OIL DRAIN HOSE	4'			
8H040-300	AIR FILTER 300C	1			
7U032-020	3/8 P/S HOSE	32"			
5A003-080	TUNER, ECU, DIABLOSPORT IN-TUN	1			
5A102-031*	ASSY, VOLT BOOST SRT8 HEMI G3	1			
8N006-020	WATER COOLR, FLDYN DUAL PASS	1			
8N105-220	WATER TANK ASSY, 2011 6.4 HEMI	1			
4CL010-190	BRKT, CAC TANK, HEMI	1			
7A250-050	1/4-20 X .50 SHCS GR8 ZINC PLT	4			
7A250-051	1/4-20 X .50 HHCS GR5 ZINC PLT	2			
7A250-101	1/4-20 X 1 HHCS ZINC PLTD	1			
7E010-075	#12 X 3/4" SHT METL SCRWB HEX	8			
7J250-001	1/4 WASHER, SAE, PLTD	7			
7P375-075	3/4" HOSE BARB UNION, BRASS	5			
7P500-026	1/2NPT X 3/4 BARB 90° BRASS	2			
7P500-075	1/2NPT X 3/4 HOSE FIT STRT NIC	5			
7R007-001	NYLON RATCHET CLAMP 1-1/8"	19			
7U038-000	3/4" HEATER HOSE	9'			

*SEE PAGE XI FOR INDIVIDUAL COMPONENTS IN ASSEMBLY



2009-2010 5.7L Automatic Challenger Tuner Kit

Part No. 4CL218-154L
PARTS LIST

ENGINEERING, INC.

IMPORTANT: Before beginning installation, verify that all parts are included in the kit. Report any shortages or damaged parts immediately.

PART NO.	DESCRIPTION	QTY	PART NO.	DESCRIPTION	QTY
008110	SMALL SILVER DIE CUT DECAL	2	4CL110-110*	ASSY, DAMPER PIN, HEMI	1
008130	LICENSE PLATE FRAME, VORTECH	1	4CL112-074*	AIR DISCH ASSY,HEMI CAR, G2	1
008341	VORTECH CHARGE COOLER DECAL	1	4CL112-030*	AIR INLET ASSY, HEMI CHAL	1
008447	1 YR S/C STRT INFO PKG ASY VOR	1	8N006-020	WATER COOLR, FLDYN DUAL PASS	1
009035	S/C LUBE, BOTTLED, VORT 3-PACK	1	8N105-220*	WATER TANK ASSY, 2011 6.4 HEMI	1
2A046-106	BELT PREMIUM 104.5", GATES	1	8N107-190*	WATER PUMP MTG ASSY, 07 CHGR	1
2F329-134	V3 S/C ASY, 2011 6.4L HEMI CHA	1	8N201-394	WELDED,CORE ASSEMBLY,HEMI	1
4CL010-160	BRKT, FLDYNE CHLLNGR DRVR	1			
4CL010-170	BRKT, FLDYNE CHLLNGR PASS	1			
4CL020-015	INSTR MAN, 09-10 5.7 HEMI CAR	1			
4CL110-074	ASSY, S/C MTG BRKT,09-10 5.7L	1			
008725	CAP, TAMPER PROOF, VORT S/C	2			
2A017-016	PILOT, 6203/5 BRG, 3/8 SCREW	1			
2A017-093	SPACER, S/C PULLEY, .093"	1			
2A017-105-222B	SPCR, BLK 1"OD X .328"ID X 2.225	5			
2A017-462	SPACER,IDLER SMOOTH 6RIB	1			
2A017-156	SPCR, SM IDLER, DBL BRG JACK	1			
2A017-876-12	SPACER, .875 OD X .475 LONG	2			
2A036-136	S/C PULLEY 3.60" 6 GROOVE W/FL	1			
2A040-051	PLY RETAINER, TAMPER PRF CAP	2			
2A040-061	RETAINER CUP, VORT S/C PLY	2			
2A042-080	BELT, GATES 20MM, 80 TOOTH	1			
2D070-159	LARGE BEARING,EXTENDED DRIVE	2			
2D070-171	JACKSHAFT, C5, H900, 1INCH	1			
4CL010-010	BRK, PWR STR MTG, 07 CHRG	1			
4CL010-020B	PLATE, HEAD, MTG, BLK ANODIZE	1			
4CL010-044B	SC, MTG, PLT, BLACK ANODIZE	1			
4CL010-200	BRKT, 6.1L HEMI CAR CLR SPT	2			
4CL010-050	BRKT, 5.7L HEMI CAR CLR SPT	2			
4CL016-011	HUB, PWR STR PLY, HEMI CAR	1			
4CL016-021	PULLEY, PWR STR, HEMI CAR	1			
4CL116-350	IDLER ASSY, 20MM GILMER, SRT8	1			
4FD017-011	PILOT, 6203/5 BRG, 1/2 SCREW	1			
4FT017-080	SPCR, COOLER SUPPORT	1			
4GR032-032	PULLEY,JACKSHAFT,C5,20MM,32T	1			
4GR116-300	IDLER ASSY, 20MM GILMER, C5	1			
4HS017-041	SPACER, LOWER S/C PLT S2000	2			
4NZ030-041	BEARING HSG, 350Z	1			
7A250-075	1/4-20 X .75 SHCS PLTD	6			
7A312-152	5/16-18 X 1.5 SHCS, ZN PLT	4			
7A375-124	3/8-16 X 1-1/4 HHCS, G5, PLATE	4			
7A375-225	3/8-16 X 2-1/4 HXHD G8	1			
7B375-075	3/8-24 X 3/4" GR8 HXHD BOLT	1			
7B375-150	3/8-24 X 1-1/2 GR8 HX	1			
7C012-100	12MM X 100MM X 1.75 HXHD BOLT	1			
7C080-066	M8 X 1.25 X 65 HXHD CL10.9	1			
7C080-090	M8 X 1.25 X 90 HXHD CL10.9	3			
7C080-100	M8 X 1.25 X 100 HXHD ZN PLT	3			
7C080-120	BOLT, 8MM X 120MM X 1.25 HXHD	1			
7G010-175	12MM X 1.75 NUT	1			
7J012-092	12MM WASHER, FLAT	1			
7J312-000	5/16 FLAT WASHER-SAE	11			
7J375-044	3/8 SAE WASHER, PLTD	4			
7J500-002	1/2" WASHER, SPLIT LOCK	1			
7K250-001	1/4" AN WASHER	6			
7U100-069	KEY, 3/16 SQUARE X .73 LONG	1			
7U100-073	KEY, 3/16 SQUARE X 1.375 LONG	1			
7U100-084	SNAP RING, EXT DRV HOUSING	1			
7X100-027	WAVE WASHER, LARGE, V2 INPUT	1			

*SEE PAGE XIV FOR INDIVIDUAL COMPONENTS IN ASSEMBLY



2009-2010 5.7L Automatic Challenger Tuner Kit (cont'd)

Part No. 4CL218-154L PARTS LIST

IMPORTANT: Before beginning installation, verify that all parts are included in the kit. Report any shortages or damaged parts immediately.

PART NO.	DESCRIPTION	QTY	PART NO.	DESCRIPTION	QTY
008110	SMALL SILVER DIE CUT DECAL	2	8N055-030	TANK, WATER TRIANGLE SHAPE	1
008130	LICENSE PLATE FRAME, VORTECH	1	8N055-050	PLASTIC CAP, SURGE TANK	1
008341	VORTECH CHARGE COOLER DECAL	1	7P500-034	1/2NPT X 3/4 BARB 90°, NICKEL	2
008447	1 YR S/C STRT INFO PKG ASY VOR	1	7P500-035	FITTING, 1/2 NPT X 3/4 BARB X	2
009035	S/C LUBE, BOTTLED, VORT 3-PACK	1	4CL010-290	BRKT, SURGE TANK, FILL '11 6.4	1
2A046-106	BELT PREMIUM 104.5", GATES	1	8N056-060	SURGE TANK, PLASTIC	1
2F329-134	V3 S/C ASY, 2011 6.4L HEMI CHA	1	7F375-016	3/8-16 HX NUT	1
4CL010-160	BRKT, FLDYNE CHLLNGR DRVR	1	2A017-881-01	SPACER, .875 OD X .532 LONG	1
4CL010-170	BRKT, FLDYNE CHLLNGR PASS	1	7J375-044	3/8 SAE WASHER, PLTD	2
4CL020-015	INSTR MAN, 09-10 5.7 HEMI CAR	1	7A375-350	3/8-16 X 3.5" HX HD GR5	1
4CL110-074*	ASSY, S/C MTG BRKT,09-10 5.7L	1	4CL010-280	MTG BRKT, CAC, 2011 6.4 HEMI	1
4CL110-110	ASSY, DAMPER PIN, HEMI	1	4CL010-160	BRKT, FLDYNE CHALLENGER DR	1
4GR010-110	GUIDE, DWL PIN INST	1	4CL010-170	BRKT, FLDYNE CHALLENGER PA	1
7C014-095	M14-1.5 X 95MM SHCS	1	8N107-190*WATER PUMP MTG ASSY, 07 CHGR	1	
7U250-019	DOWEL PIN, 1/4X1/2 +.001"	1	5W001-011	16-14 GA RING TERM .26" HOLE	1
7U250-026	DRILL BUSHING, 1/4 ID, 3/8 OD, 1/2L	1	5W001-013	14-16 GA BUTT CONN BLU INSUL	2
4CL112-074	AIR DISCH ASSY,HEMI CAR, G2	1	5W001-024	MINI ATC FUSE TAP	1
4CL010-310	DISCHARGE DUCT SUPPORT	1	5W001-025	FEMALE SLIDE,INSULATED,MINI	1
4CL012-074	DISCHARGE DUCT "A" COATED	1	5W001-054	18 GA FUSE HOLDER	1
4CL012-084	DISCHARGE DUCT "B" COATED	1	5W014-030	14GA STRD WIRE BLACK	5
4CL012-104	DISCH TUBE "C", 2009 5.7L HEMI	1	7R003-027	ADEL CLAMP,1-11/16"	1
7PS275-100	SLEEVE, BLACK, 2.750D X 1.00	1	8F001-402	PUMP, WATER, PIERBURG	1
7PS275-300	SLEEVE, BLACK, 2.75D X 3.0	4	8N100-001	NYLON MOUNTING KIT	1
7PS350-279	ELBOW, SIL 3.5X2.75 90°, BLK	1	8N201-394	WELDED,CORE ASSEMBLY,HEMI	1
7R002-016	#16 SAE TYPE F SS HOSE CLAMP	2	*SEE PAGE XIII FOR INDIVIDUAL COMPONENTS IN ASSEMBLY		
7R002-044	#44 SAE TYPE F SS HOSE CLAMP	10			
7R002-056	#56 SAE TYPE F SS HOSE CLAMP	1			
7U030-046	5/32" VACUUM LINE	5'			
7U034-016	1" GS HEATER HOSE	25			
8D001-004	COMPRESS BYPASS VALVE, G2	1			
8H040-075	FILTER, 1" BYPASS VALVE	1			
4CL112-030	AIR INLET ASSY, HEMI CHAL	1			
4CL010-180	BRKT, CHALLENGER AIR INLET	1			
4CL012-030	DUCT, INLET 08 HEMI CHALLENGER	1			
7A250-039	1/4-20 X 3/8" SHCS ZINC PLTD	2			
7J250-001	1/4 WASHER, SAE, PLTD	2			
7R002-056	#56 SAE TYPE F SS HOSE CLAMP	1			
7R002-080	#80 SAE TYPE F SS HOSE CLAMP	1			
7S500-351	INLET SLEEVE, HEMI, 5 X 3.5	1			
8H040-235	AIR FILTER, 4" FLG X 7.0L	1			
7P500-009	1/2"X90 HOSE BARB UNION	1			
7U030-036	1/2" OIL DRAIN HOSE	4'			
8H040-300	AIR FILTER 300C	1			
7U032-020	3/8 P/S HOSE	32"			
8N006-020	WATER COOLR, FLDYN DUAL PASS	1			
8N105-220	WATER TANK ASSY, 2011 6.4 HEMI	1			
4CL010-190	BRKT, CAC TANK, HEMI	1			
7A250-050	1/4-20 X .50 SHCS GR8 ZINC PLT	4			
7A250-051	1/4-20 X .50 HHCS GR5 ZINC PLT	2			
7A250-101	1/4-20 X 1 HHCS ZINC PLTD	1			
7E010-075	#12 X 3/4" SHT METL SCRWB HEX	8			
7J250-001	1/4 WASHER, SAE, PLTD	7			
7P375-075	3/4" HOSE BARB UNION, BRASS	5			
7P500-026	1/2NPT X 3/4 BARB 90° BRASS	2			
7P500-075	1/2NPT X 3/4 HOSE FIT STRT NIC	5			
7R007-001	NYLON RATCHET CLAMP 1-1/8"	19			
7U038-000	3/4" HEATER HOSE	9'			
7U038-012	HOSE, 3/4 DIA 90°, 4 X 12 LEGS	5			
7U038-150	HOSE, 3/4 D X 150° MOLDED HOSE	1			
7U100-044	TIE WRAP, 4" NYLON	10			
7U100-055	TIE WRAP, 7.5" NYLON	10			

1. PREPARATION AND REMOVAL

- A. Disconnect negative cable at the battery.
- B. Remove the plastic engine covers and set aside.
- C. Remove the valve cover breather hose from the factory air inlet duct. Remove the air filter and all ducting upstream of the throttle body.
- D. Unplug the IAT (Inlet Air Temperature) sensor connector and remove it from the air filter housing. Set it aside for later use.
- E. Remove the accessory drive belt.
- F. Unplug the fan electrical connector, then remove fan shroud hardware. Pull up and remove the electric radiator fan assembly from the vehicle (cooling system may need to be drained and upper radiator hose removed).
- G. **2009-2010 Challenger A/T Only:** Using an appropriate power steering pulley removal tool, remove the power steering pump pulley from the pump.
- H. **2009-2010 Challenger A/T Only:** Install the supplied power steering pulley hub onto the power steering pump so that it is flush with the end of the shaft. (See Fig. 1-a)



Fig. 1-a (A/T Only)

2. FRONT FASCIA REMOVAL

- A. Remove the plastic splash pan on the bottom of the vehicle.
- B. Remove the electrical plug for the fog lights located on the passenger side of the vehicle.
- C. Remove the plastic rivets securing the inner fender liners (new rivets are supplied for re-installation).
- D. Locate the two 10mm headed screws in the front outer edge of the inner fender (one on each side of the vehicle) (See Fig 2-a). Remove the screws and set aside to be reinstalled in a later step.
- E. Locate and remove the four 10 mm nuts (Two on each side of the vehicle) (See Fig. 2-b)
- F. Remove the two covers from the top of the fascia (See Fig. 2-c)
- G. Remove the six plastic retaining clips securing the top of the fascia to the radiator core support.
- H. Gently pull the corners of the fascia way from the fenders. And remove the fascia.
- I. Remove the plastic clips retaining the inner fascia support. And remove the inner fascia support. (See Fig. 2-d, 2-e)
- J. Remove the three 8 mm headed screws from the drivers side headlight.
- K. Pull the headlight straightforward and remove.
- L. Remove the two head light plugs. And set the head light assembly aside.



Fig. 2-a (Challenger Shown)

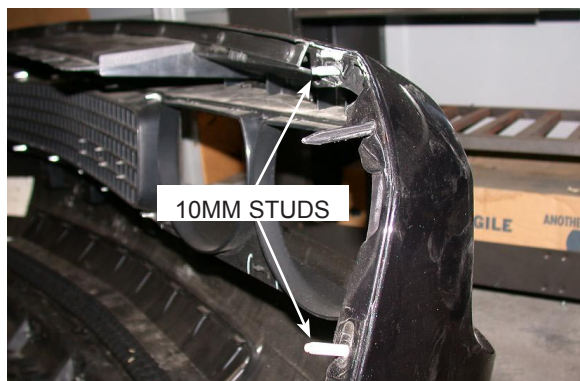

Fig. 2-b (Challenger Shown)



Fig. 2-c (Challenger Shown)



Fig. 2-d (Challenger Shown)

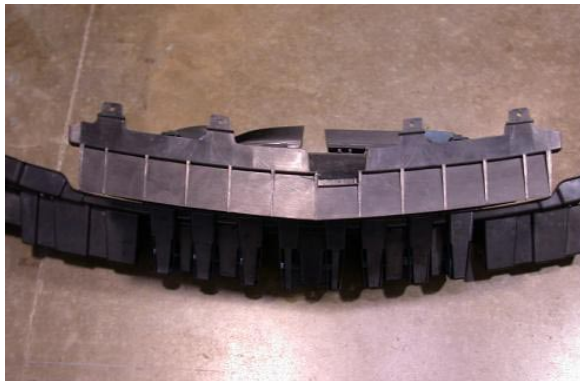

Fig. 2-e (Challenger Shown)

3. HARMONIC DAMPER DOWEL PIN INSTALLATION

NOTE: The purpose of this section is to provide access to the harmonic damper bolt area so that the crankshaft can be pinned to the damper to prevent the damper from spinning on the crankshaft. The following steps will work on all or most applications. If it is not possible to get adequate clearance by performing the following steps, follow the manufacturer's steps for removing the harmonic damper until there is sufficient room to work in.

- A. Remove the crankshaft damper bolt. (A factory tool may be used to keep the engine from rotating or carefully use a pry tool to keep the damper from rotating.)
- B. Install the supplied drill guide with the raised section piloting in the damper bore. Secure in place by installing the supplied socket head cap screw. Do not over-tighten the screw as it may distort the drill guide (its purpose is just to hold the guide in place while drilling). See Fig. 3-a.
- C. Using a small drill motor (right angle pneumatic works well), mark a 1/4" drill bit with electrical tape or a drill stop so that the hole will be deep enough for the supplied 1/2" long dowel pin. See Fig. 3-b.
- D. Drill hole in damper/crankshaft.
- E. Remove the socket head cap screw.
- F. Clean area of metal chips and install the supplied dowel pin in the drilled hole making sure that it does not protrude past the damper face.
- G. Install and tighten the crankshaft damper bolt to 129 ft-lbs (176 Nm).
- H. Re-install the radiator fans and verify that the electrical connector is plugged in.



Fig. 3-a



Fig. 3-b

4. FUEL INJECTOR REPLACEMENT

- A. Relieve the fuel system pressure
- B. Disconnect the eight fuel injector plugs and retaining clips from the injectors.
- C. Remove the four screws that hold down the fuel rail on the intake manifold. Lift up on the rails evenly and remove all eight injectors.
- D. Using a small amount of clean motor oil, lightly lubricate the O-rings on both ends of the Vortech supplied fuel injectors.
- E. Install the new injectors into the fuel rails with the terminals facing outward.
- F. Carefully lower the fuel rail/injector assembly down onto the intake manifold.
- G. Check to see that each injector has been seated properly into the intake manifold.
- H. Tighten down the passenger side of the fuel rail assembly with the original bolts and attach the injector plugs to the injectors.
- I. Use the supplied PCV valve, 1/2" to 3/8" hose union and 3/8" 90° hose to splice into the factory crank case breather hose as shown in Fig. 4-a.
- J. Tighten a stepless clamp on each hose connection.
- K. Cut the brake booster line next to the brake booster and install the aluminum MAP sensor block assembly. Install a clamp on each connection. Unplug the connector from the factory MAP sensor on the back of the intake manifold and plug it into the supplied MAP sensor. (See Fig. 4-b) **2009-2010 5.7L Challenger Only:** Install dummy plug into factory MAP sending unit to keep it from rotating out. (See Fig. 4-c)

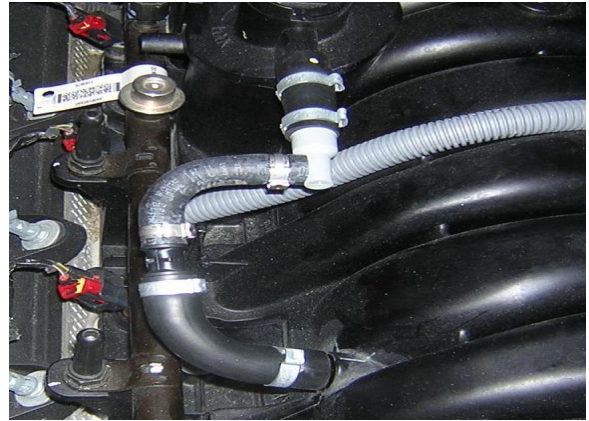

Fig. 4-a



Fig. 4-b

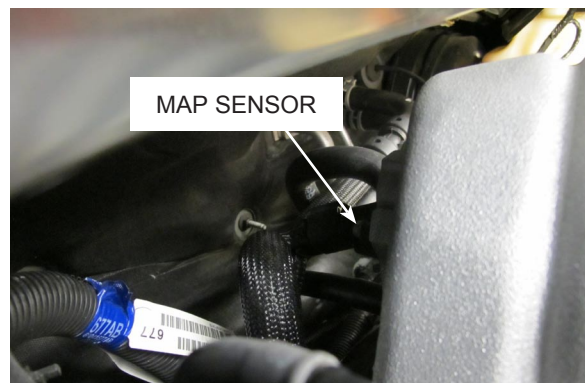

Fig. 4-c

5. SUPERCHARGER MOUNTING PLATE INSTALLATION

- A. Remove the three bolts securing the power steering pump to the head. **2009-2010 5.7L engines with M/T** require removal of the inlet fitting for the power steering pump to be replaced with the supplied fitting. Set aside the hose as it will be used in a later step. Refer to Fig. 5-b, 5-c & 5-d for final installation reference
- B. Loosely attach the steel bracket to the back of the primary mounting plate.
- C. Attach the supercharger mounting plate to the primary mounting plate using the supplied M8 x90mm bolts and spacers.
- D. Without installing hardware, sandwich the power steering pump between the steel plate and the supercharger mounting plate. At this point, tighten the two bolts attaching the steel bracket to the primary mounting plate. (Loosely installed in Steb B.)

NOTE: This is difficult to accomplish with the power steering lines connected. It may be easier to completely remove the power steering pump from the vehicle and install onto the mounting bracket assembly out of the vehicle.

NOTE: **2009-2010 5.7L Challenger M6 Only:** continue with steps E, F, G. All other systems reattach the power steering lines now and skip to Section 6.

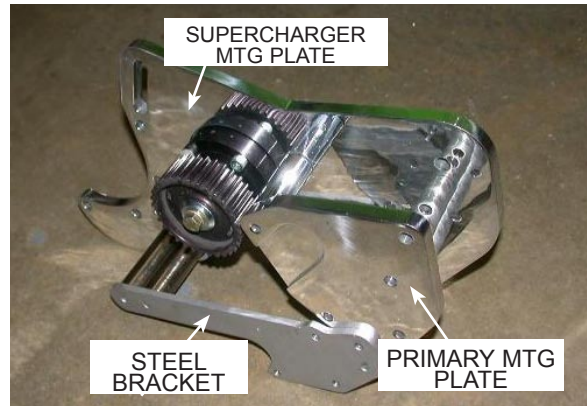

Fig. 5-a



Fig. 5-b (2009-2010 5.7L Challenger M6)

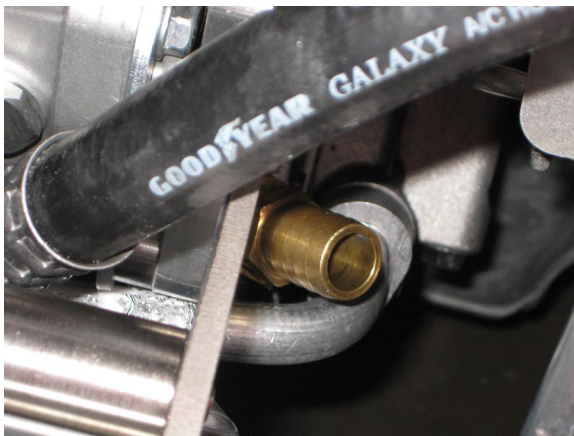

Fig. 5-d (2009-2010 5.7L Challenger M6)



Fig. 5-c (2009-2010 5.7L Challenger M6)

5. SUPERCHARGER MOUNTING PLATE INSTALLATION

Steps E, F and G apply to 2009-2010 5.7L Challenger M6 Only:

- E. Remove power steering hose from pump to reservoir. Cut hose as depicted in Fig. 5-e Set aside the two longer pieces of hose and discard the two shorter pieces. Replace the small bend with a $\frac{3}{4}$ hose union and attach the 2 pieces of hose together.
- F. Install the hose so that the end with the single bend attaches to the pump. Do not install clamps. Mark union for correct clocking. Remove the hose from the car and install stepless clamps at union. (See Fig. 5-f)
- G. Install hose assembly back into car using the factory clamp to secure the hose to the reservoir and a supplied hose clamp to attach the hose to the power steering pump. (See Fig. 5-g)



Fig. 5-e (2009-2010 5.7L Charger/Challenger M6)



Fig. 5-f (2009-2010 5.7L Charger/Challenger M6)

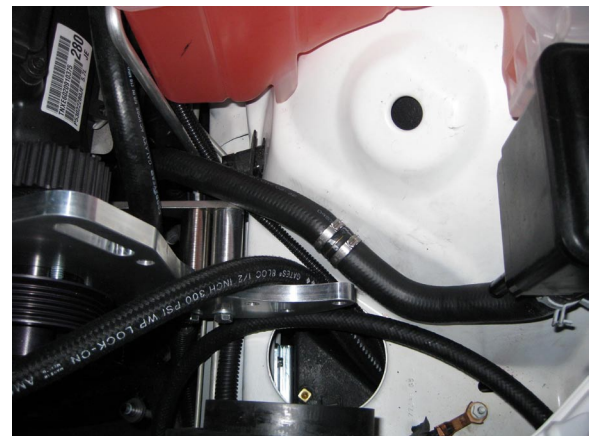

Fig. 5-g (2009-2010 5.7L Charger/Challenger M6)

5. SUPERCHARGER MOUNTING PLATE INSTALLATION, CONT'D

- H. Start the supplied 8mm bolt in the outside hole making sure that it does not protrude through the back and impact the a/c line (2009-2010 5.7L engines bend the a/c lines slightly as necessary. Zip tie a piece of supplied 3/4" hose to bracket to prevent rubbing. See Fig. 5-h).
- I. Install a .475" spacer between the supercharger mounting plate and the power steering pump at the two remaining power steering pump mounting holes. Install 8mm x 90mm bolts and washers.
- J. Position the supercharger mounting plate assembly in front of the engine and secure it to the head using the three M8 x 100 mm bolts and one M8 x 120mm bolt. (See Fig. 5-i).
- K. Tighten all of the mounting plate bolts in steps so that the protruding bolt heads do not hit the power steering pump pulley.

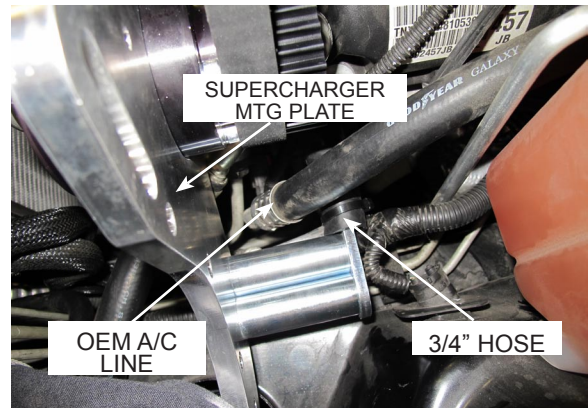

Fig. 5-h



Fig. 5-i

6. SUPERCHARGER INSTALLATION

- A. Install the supplied 3" aluminum idler using the inner most 3/8-16 hole on the mounting plate for the idler pulley. Make sure that the snap ring side is facing forward (away from the mounting plate). (See Fig. 6-a).
- B. Install the supplied power steering pump pulley on the already installed hub using the supplied 1/4" hardware.
- C. Install the supplied accessory drive belt (as shown in Fig. 6-b).
- D. Position the supercharger in front of the mounting plate assembly in front of the engine and install and tighten the four 3/8" x 1 1/4" bolts.
- E. Install the supplied cog belt around the pulleys on the mounting plate assembly.
- F. Using the supplied M12 x 100mm bolt, install the supplied 3.5" aluminum idler with the bearing retaining snap ring pointed towards the front of the vehicle. The screw should pass through a flat washer, S/C mounting plate, 1.55" idler spacer, the idler, thick bearing washer, lock washer and nut. Install the supplied nut and lock washer on the end of the screw and tighten the idler so that the gilmer belt is snug. (See Fig. 6-c).
- G. Secure the remote drain hose away from the belt and hoses using tie-wraps.

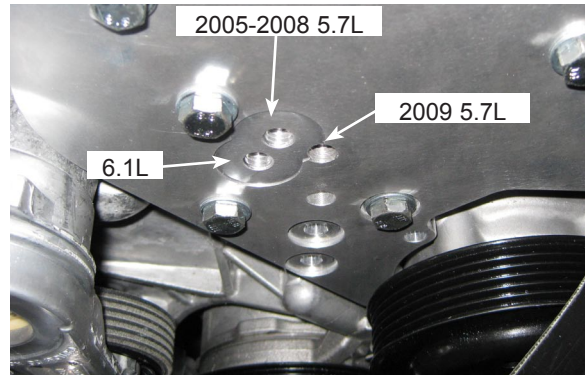

Fig. 6-a

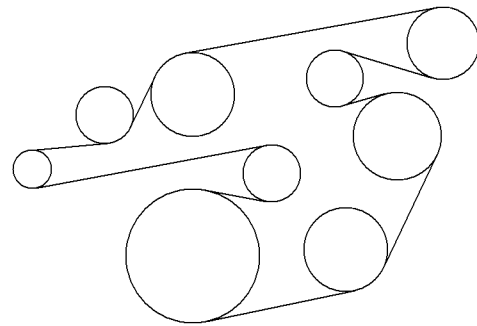

Fig. 6-b



Fig. 6-c

7. AIR INLET INSTALLATION

- A. Locate assembly (4CL112-030) insure that all parts are present.
- B. Attach the rubber sleeve to the plastic duct with the hose claps provided.
- C. Attach the air filter to the inlet duct. (See Fig 7-a)
- D. Attach the mounting bracket to the duct with the fasteners provided. (See Fig 7-b)
- E. Remove the 15 mm headed bolt at the bottom of the core support. Set the bolt aside to be reinstalled in a later step (See Fig 7-c)



Fig. 7-a



Fig. 7-b



Fig. 7-c

7. AIR INLET INSTALLATION, CONT'D

- F. Remove the hood latch cable clip and move to the side to be reattached to the inlet duct-mounting bracket in a later step.
- G. Remove the 3/8" power steering hose from the drivers side of power steering cooler and from the reservoir. Set aside; it will not be used.
- H. Locate the 30-inch piece of power steering hose that is provided. Install the hose clamps from the factor power steering hose.
- I. Route the new power steering hose down and behind the core support between the radiator and the core support. (See Fig 7-d)
- J. Attach the inlet duct to the inlet of the super-charger and secure with the hose clamp previously installed.
- K. Reinstall the 15 mm headed bolt removed in an earlier step. Attach the hood latch cable to the bracket supporting the inlet duct. (See Fig 7-e)
- L. Attach the crank case breather hose to the 90° plastic fitting on the end of the air filter. (See Fig 7-f)
- M. Route the breather hose through the round hole located in the inner fender to the crank case breather fitting on the intake manifold.
- N. Check the power steering fluid level and re-fill as necessary.
- O. Re-install headlight, hardware and connectors.



Fig. 7-d



Fig. 7-e



Fig. 7-f

8. CHARGE AIR COOLER/DISCHARGE ASSEMBLY INSTALLATION

- A. Remove the screws securing the coil pack that's 3rd from the front of the vehicle on the driver side. Install the supplied discharge tube support bracket on top of the coil pack, securing it to the engine using the factory coil pack screws (See Fig. 8-a). On the passenger side, repeat the same step but use the 1st coil pack, closest to the front of the vehicle.
- B. Remove the upper alternator bolt & discard. It will not be reused. Install the supplied bolt into the upper alternator mount. Be sure to use the provided washers.
- C. Once the supplied bolt is in place, slide on the supplied .155" spacer & thread on provided nut & washer by hand. Do not tighten all the way. (See Fig. 8-b)
- D. Using a 15mm socket, remove the screw to the left of the throttle body, directly above the thermostat housing. Set screw aside as it will be reused.
- E. Locate supplied charge air cooler support. Notice the bottom of the charge air cooler support is slotted (See Fig. 8-c). Slide the slotted section of the charge air cooler support in between the .155" spacer & washer closest to the nut previously installed on the upper alternator mount. Once the slotted section of the charge air cooler support is in place, locate the 15mm screw previously removed & install through the upper tab of the charge air cooler support, threading the screw back into its original location. (See Fig. 8-d)
- F. Tighten 15mm screw & upper alternator mount hardware. Place the charge air cooler on top of the charge air cooler support.

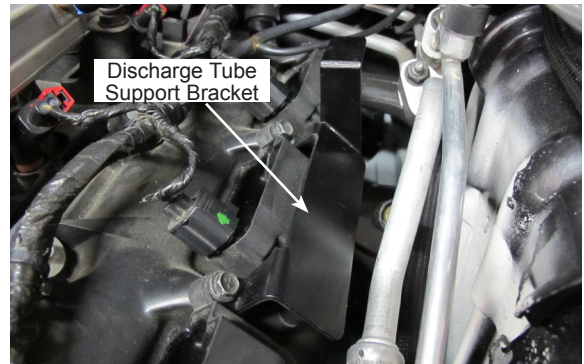

Fig. 8-a

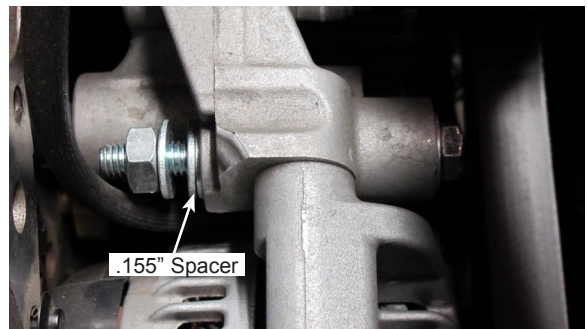

Fig. 8-b



Fig. 8-c



Fig. 8-d

8. CHARGE AIR COOLER/DISCHARGE ASSEMBLY INSTALLATION, CONT'D

NOTE: For the following procedures, it's important to NOT tighten the hose clamps until Step Q.

- G. (See “Discharge Tube Identification” below). Locate discharge tube B & install the supplied silicone sleeve onto the shorter leg of the tube with the 45° bends. Place hose clamps hand tight onto the sleeve but do not tighten all the way.
- H. On the shorter leg of discharge tube B, orientate the hose clamps so they are pushed slightly towards the back. This is in preparation for a later step. (See Fig. 8-e)
- I. Slide a silicone coupler onto the long leg of discharge tube B, then slide the tube onto the charge air cooler. Make sure discharge tube B is resting on the discharge tube support bracket on the passenger side. This will leave the other end of the tube near the back of the engine, close to the firewall.
- J. Locate discharge tube C & install the factory IAT sensor, using the supplied rubber grommet. (See Fig. 8-f)
- K. Install 90 degree silicone elbow onto the throttle body.
- L. Grab discharge tube C & place the tube so that the section with the two 45° bends are near the back of the engine, close to the firewall. Slide discharge tube C into the silicone coupler previously installed onto discharge tube B (See Fig. 8-g). Insert the other end of discharge tube C into the 90° silicone elbow previously installed on the throttle body.
- M. Locate supplied 1” silicone coupler & cut it so it can be placed over discharge tube C. Place the cut coupler over discharge tube C & place it in a way to trap the drivers side discharge tube support bracket between the coupler & discharge tube C. Place supplied hose clamp over the coupler. (See Fig. 8-h)

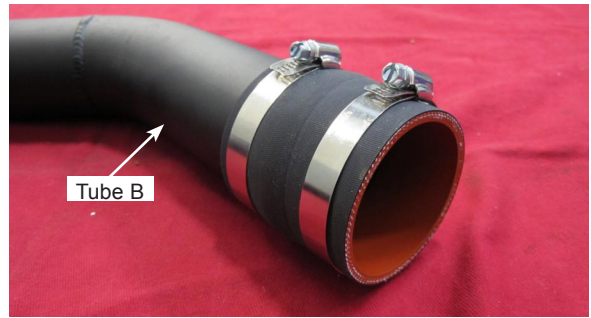

Fig. 8-e

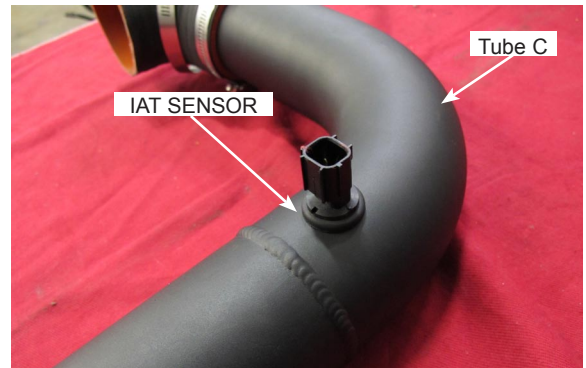

Fig. 8-f

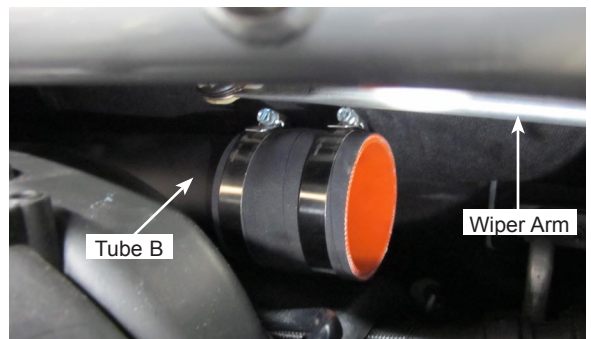
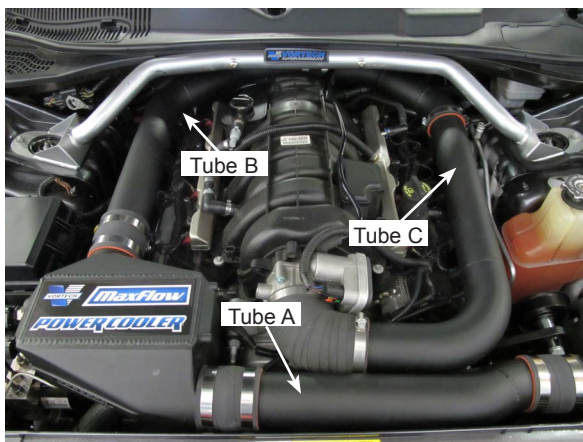

Fig. 8-g



Discharge Tube Identification



Fig. 8-h

8. CHARGE AIR COOLER/DISCHARGE ASSEMBLY INSTALLATION, CONT'D

- N. Reconnect the IAT Sensor plug to the IAT sensor, making sure the wire is clear of the cog belt. (See Fig. 8-i)
- O. Locate discharge tube A. Install the supplied bypass valve & filter onto the welded barb using the supplied 1" hose. Connect the supplied 5/32" vacuum hose to the bypass valve & route under the throttle body, across the driver's side of the engine, connecting the other end of the vacuum hose to the previously installed MAP sensor block. Use zip ties to secure the vacuum hose to the fuel injector harness.
- P. Place discharge tube A in between the charge air cooler & supercharger outlet using the supplied silicone couplers & hose clamps. The end of the tube with the bends will go onto the supercharger outlet. Be sure that the bypass valve is pointing straight down towards the bottom of the vehicle, making sure that it's clear of the accessory drive pulleys & belt.

NOTE: To keep the vacuum hose from rubbing against the accessory drive belt, it's suggested to use zip ties to hold the vacuum hose against the 1" bypass valve hose. (See Fig. 8-j)

- Q. Verify that all of the discharge tubes are in place & proceed to tighten all of the hose clamps. Make any necessary adjustments to the tubes for proper fitment. The hose clamps on the silicone coupler connecting discharge tube B & discharge tube C installed in a previous step must be tightened using an 8mm socket, swivel joint & a long extension. The hose clamps must be pushed towards the firewall to make clearance for the windshield wiper arms. Failure to do so will result in the windshield wiper arms coming into contact with the hose clamps.
- R. Locate the engine cover & modify it so the driver side of the engine cover clears discharge tube C & the passenger side of the cover clears the charge air cooler. (See Figs. 8-k, 8-l)

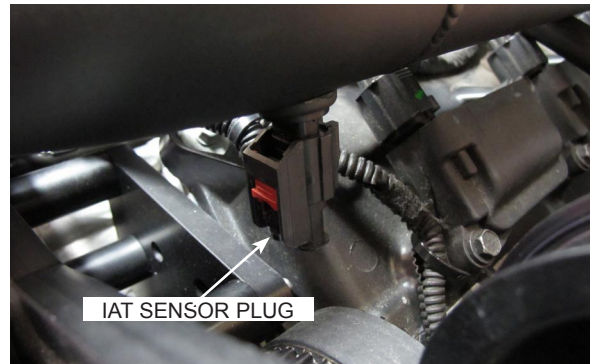

Fig. 8-i



Fig. 8-j



Fig. 8-k



Fig. 8-l

9. RESERVOIR AND WATER PUMP ASSEMBLY AND INSTALLATION

- A. Attach the surge tank bracket to the surge tank using 1/4-20 x .5" cap screws. Mount the surge tank bracket to the slot in the factory coolant reservoir. (See Fig. 9-a)
- B. In the area in front of the drivers side front wheel, position the water reservoir/bracket next to the frame rail. Orient the assembly for the best clearance, at least 6" from the rear face of the bumper. (See Fig. 9-b)
- C. Mark the mounting bracket location and remove. Drill two 11/64" holes for the supplied #12 sheet metal screws.
- D. Using thread sealant, install the 1/2" NPT 90° hose barb fitting into the top and bottom of the supplied plastic reservoir.
- E. Secure the assembly to the frame rail using two #12 sheet metal screws. (See Fig. 9-c)
- F. Trial fit the front bumper cover to verify water reservoir clearance.
- G. Cut off the electrical plug on the water pump leaving as much wire connected to the pump as possible. Install the supplied 1/4" eyelet onto the water pump ground wire (brown wire).
- H. Connect the pump inlet to the bottom reservoir fitting with a piece of supplied hose. Point the pump to discharge forward (and slightly up, to allow air to escape the pump housing). Secure the hose with the nylon ratchet clamps on both ends. Drill a hole in the radiator support and secure the water pump to it using an adel clamp and #12 sheet metal screw. Make sure to ground the water pump under the mounting screw. (See Fig. 9-d)
- I. Connect a 90° molded hose to the barbed fitting on top of the reservoir & secure with a nylon ratchet clamp (short leg of the hose gets attached to the reservoir). Locate the supplied 3/4" hose & connect it to the 90° molded hose using a hose mender & nylon ratchet clamps. Run the hose up to the area next to the drivers side valve cover, routing the hose behind the drivers side headlight. Attach the 3/4" hose to the lower barbed fitting of the surge tank & secure with a nylon ratchet clamp (cut the hose to the appropriate length).
- J. Drill a 5/8" hole in the rear facing side of the power distribution box lid approx. 3" from the inner edge. Insert the supplied grommet into the hole. Install the supplied fuse holder from the inside of the lid, pressing one end into the grommet. Connect the fuse tap and slide connector to the fuel pump fuse (refer to owners manual for fuel pump fuse). Connect the remaining end of the fuse holder to the water pump wire using the supplied wire. Route the wire behind the engine, following the factory loom. Install the supplied split loom over the wire. (See Fig. 9-e)



Fig. 9-a



Fig. 9-b



Fig. 9-c

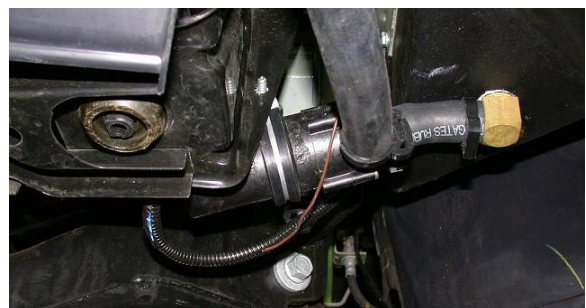

Fig. 9-d

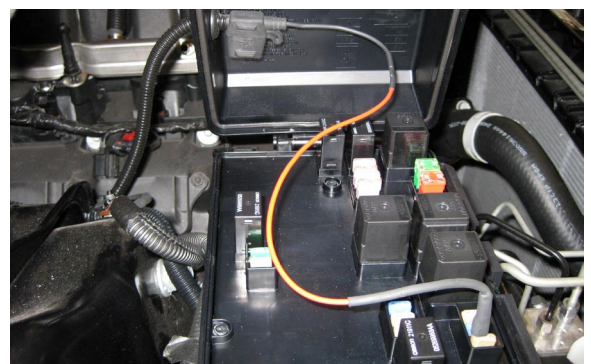

Fig. 9-e

10. CHARGE AIR COOLER RADIATOR INSTALLATION

- A. Attach the supplied brackets to each side of the CAC radiator as shown in figs. 10-a and 10-b. Remove the 8mm screws from the A/C condenser & install the CAC radiator to the condenser. Remove the two small plastic panels from the front bumper cover as shown in Fig. 10-c.
- B. Connect the water pump discharge to the bottom hose barb on the CAC radiator using the supplied 90° molded hose (and additional 3/4" hose if needed). See Fig. 10-f (on the next page) for CAC hose routing.
- C. Attach two 90° molded hoses to the CAC core & secure them with nylon ratchet clamps. Point the two hoses towards the front of the vehicle. (See Fig. 10-d)
- D. Locate the 3/4" x 150° molded hose & attach it to the upper hose barb on the CAC radiator. Connect the other end of the 3/4" x 150° hose to the 90° molded hose on the water inlet fitting (upper fitting) on the CAC core using the supplied hose menders & 3/4" hose (cut hose to the appropriate length). Secure using nylon ratchet clamps. Run the hose along the top of the bumper beam. (See Fig. 10-e)
- E. Using a hose mender, attach the 3/4" hose to the remaining 90° molded hose on the CAC core. Run the 3/4" hose parallel to the previously installed hose, routing the end of the hose behind the drivers side headlight, up towards the drivers side valve cover. Attach the other end of the 3/4" hose to the upper fitting of the previously installed surge tank & secure with nylon ratchet clamps. Use zip ties to secure the two hoses running along the top of the bumper beam.
- F. Remove cap from surge tank and slowly fill system with 25% / 75% coolant/water mix. Check for leaks.
- G. Re-install the front inner and outer fascias and fender liner in reverse order of removal.

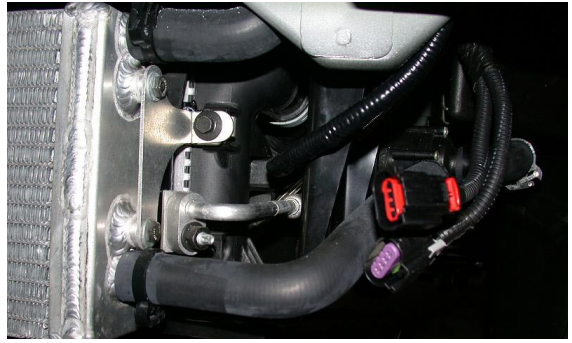

Fig. 10-a

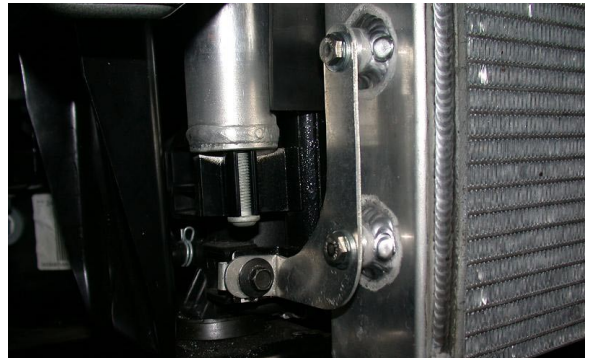

Fig. 10-b



Fig. 10-c



Fig. 10-e

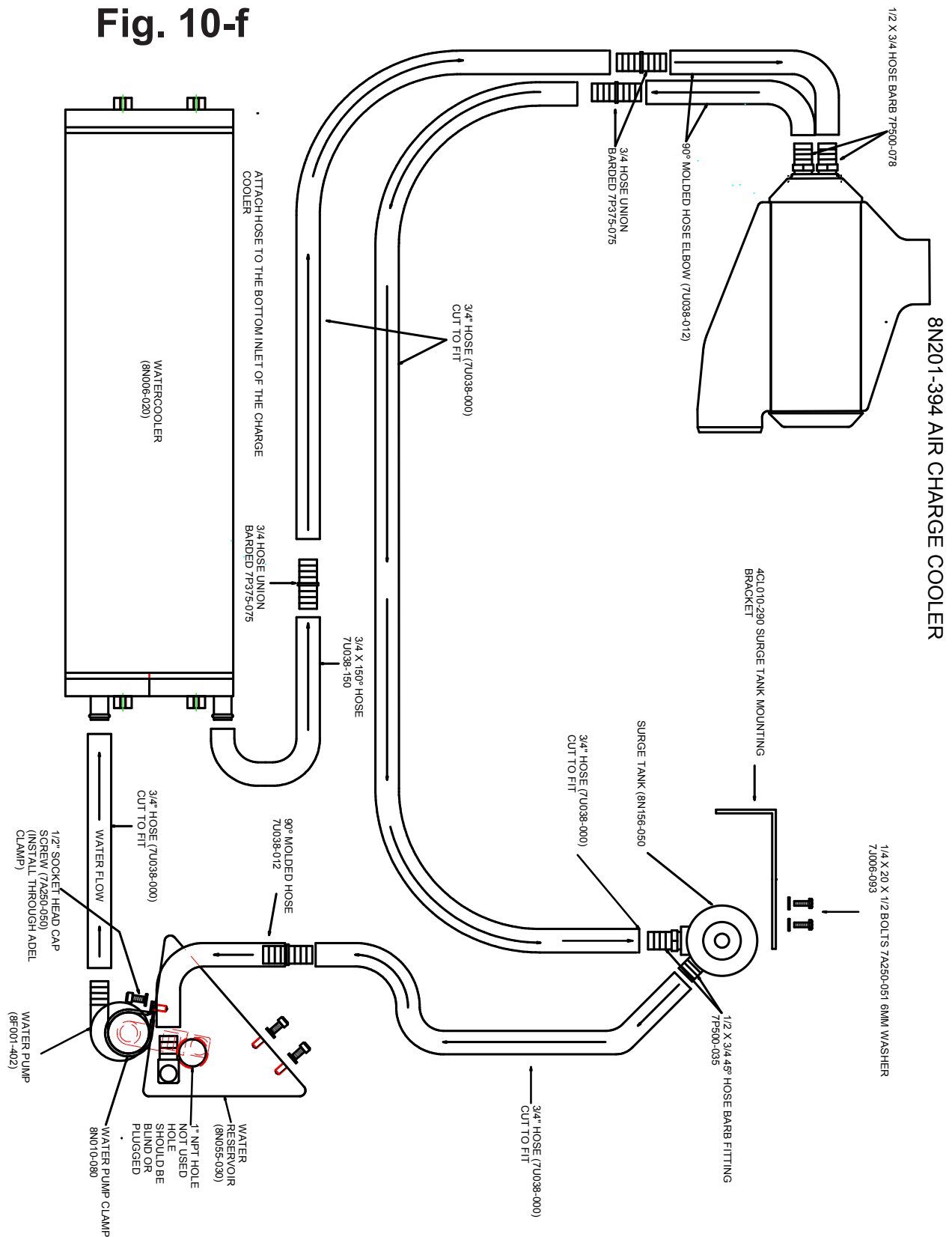

Fig. 10-d

10. CHARGE AIR COOLER RADIATOR INSTALLATION, CONT'D

CAC HOSE ROUTING

Fig. 10-f



11. FUEL PUMP BOOSTER INSTALLATION

- A. Open trunk and remove carpet to expose the Styrofoam organizer in the spare tire well and remove the organizer. Using the FPB mounting plate as a template, mark (2) drill hole locations. Using a 17/64" drill bit, drill through, at the two marked locations (see Fig. 11-a).
- B. Secure the supplied FPB to the mounting plate with the provided # 10 hardware screws, washers, and nylock nuts. Then mount the FPB assembly to the two previously drilled 17/64" holes in the spare tire well using the provided 1/4-20 screws, washers, and nylock nuts.
- C. Locate the rubber grommet on the driver's side of the firewall. Make a small slice in the grommet.
- D. Remove the two plastic clips securing the under dash cover. Set aside the cover to be installed in a later step. (See Fig. 11-b)
- E. Lift up the driver side plastic door sill running across the door and remove. (See Fig. 11-c) It will be reinstalled in a later step.
- F. Remove the rear seat by lifting up on each side of the lower section. (The upper section does not need to be removed)
- G. Locate the supplied 1/8" nylon Instrument tubing and install it into the 1/4" plastic split loom.
- H. Route the 1/8" nylon tube assembly along the door sill to the FPB previously installed in the trunk. Secure the loom with provided tie wraps. Locate the 7/64 vacuum hose and cut a 2" piece and install one end on the 1/8" nylon tube and the other end to the vacuum port on the FPB. Secure hose connections with tie wraps. This will be used for boost reference.

NOTE: When routing tubing, ensure nylon tubing does not get kinked or potentially pinched during vehicle operation.

- I. Route the other end of the 1/8" nylon tube assembly loom through the firewall grommet (Previously cut in step 11-C) and into the engine bay. Continue routing the tube assembly to the 5/32" tee fitting installed in the bypass valve line. (Previous step 10-D) Cut another 2" piece of 7/64" vacuum hose and attach to tee fitting. Secure with plastic tie wraps.

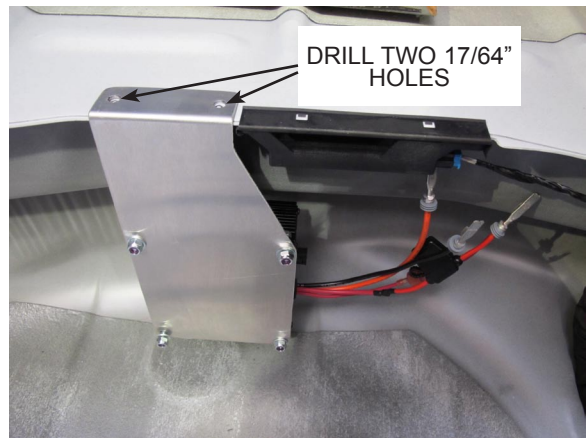

Fig. 11-a



Fig. 11-b



Fig. 11-c

11. FUEL PUMP VOLTAGE BOOSTER INSTALLATION con't

- J. Locate the factory fuel pump wires under the rear seat driver's side. Remove the tape from the wires. Separate the blue with orange or blue with red depending on model year (See Fig. 11-d).

NOTE: Crimp on connectors are provided but it is recommended that all of the wire connections be soldered and insulated.

- K. Cut the blue with red/orange trace wire leaving approximately 4" out of the fuel pump. Attach the 12ga. orange wire provided in your kit to the 12ga. orange wire from the FPB. Attach the other end to the fuel pump. This wire will power the fuel pump. (Refer to wiring diagram Fig. 11-h)

NOTE: Refer to the fuel pump wiring diagram that is provided for further explanation if needed (Fig. 11-h).

- L. Attach the 14ga. red wire provided in your kit to the 14ga red wire from the FPB. Attach the other end to the blue with red/orange trace wire into the OEM wire harness. (Refer to wiring diagram Fig. 11-h)

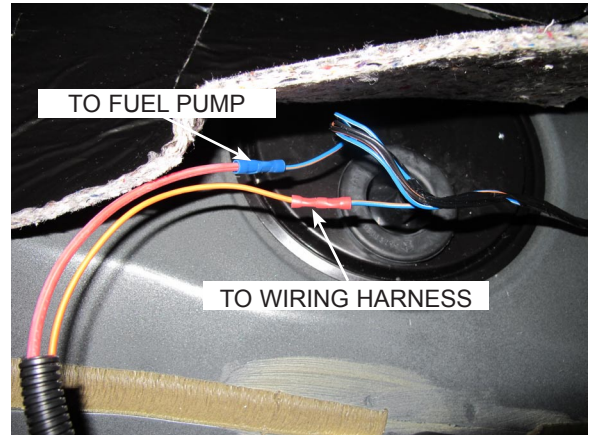

Fig. 11-d

11. FUEL PUMP VOLTAGE BOOSTER INSTALLATION con't

- M. Reinstall the rear seat, door sill, and under dash cover at this time.
- N. On the FPB box, locate the red 12 ga. wire with fuse holder. Cut off the fuse holder and discard. Locate the 12 ga. red wire provided and connect where fuse holder was cut off. Locate the provided black 12ga. wire and connect to the black wire on the FPB.
- O. Route the red power wire and black ground wire toward the fuse box next to the battery. Trim the wires to proper lengths to attach to factory ground lug and factory power distribution box. Locate the provided fuse holder and cut the center of the wire loop. Attach one end to the red 12 ga. power wire from FPB. Use the supplied ring terminals crimp, solder, and attach to factory lugs. (See Figs. 11-e, 11-f, 11-g for close up view.) Install the supplied 40amp fuse into fuse holder after all connections are complete.
- P. Reinstall the trunk organizer and carpet at this time.

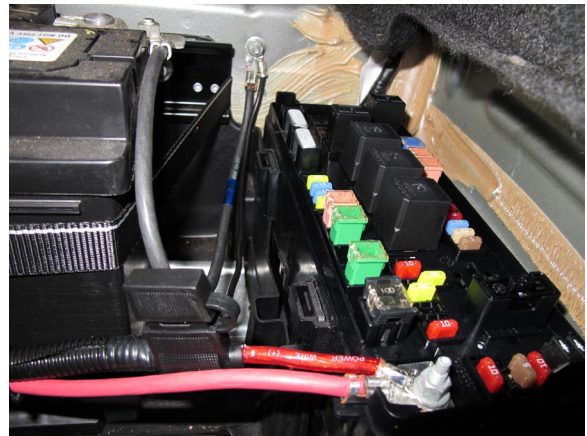

Fig. 11-e

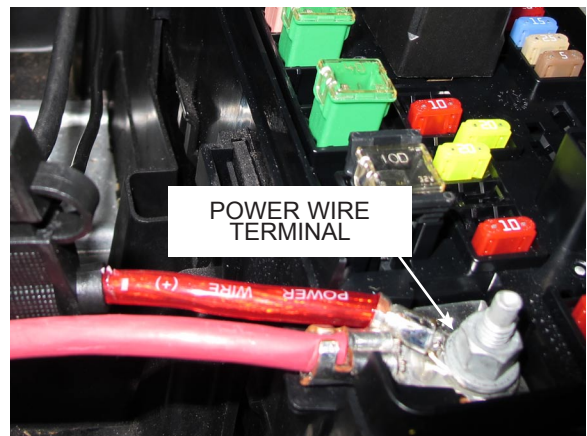

Fig. 11-f

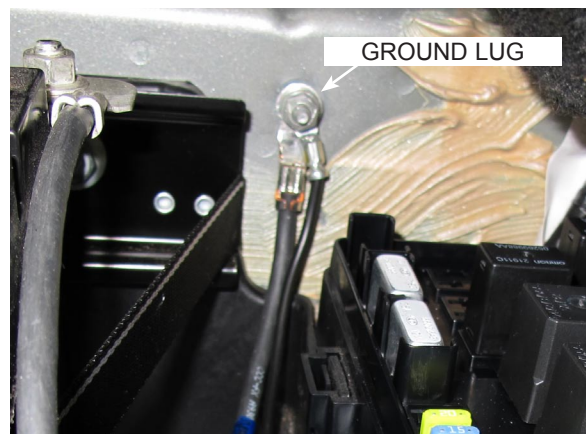
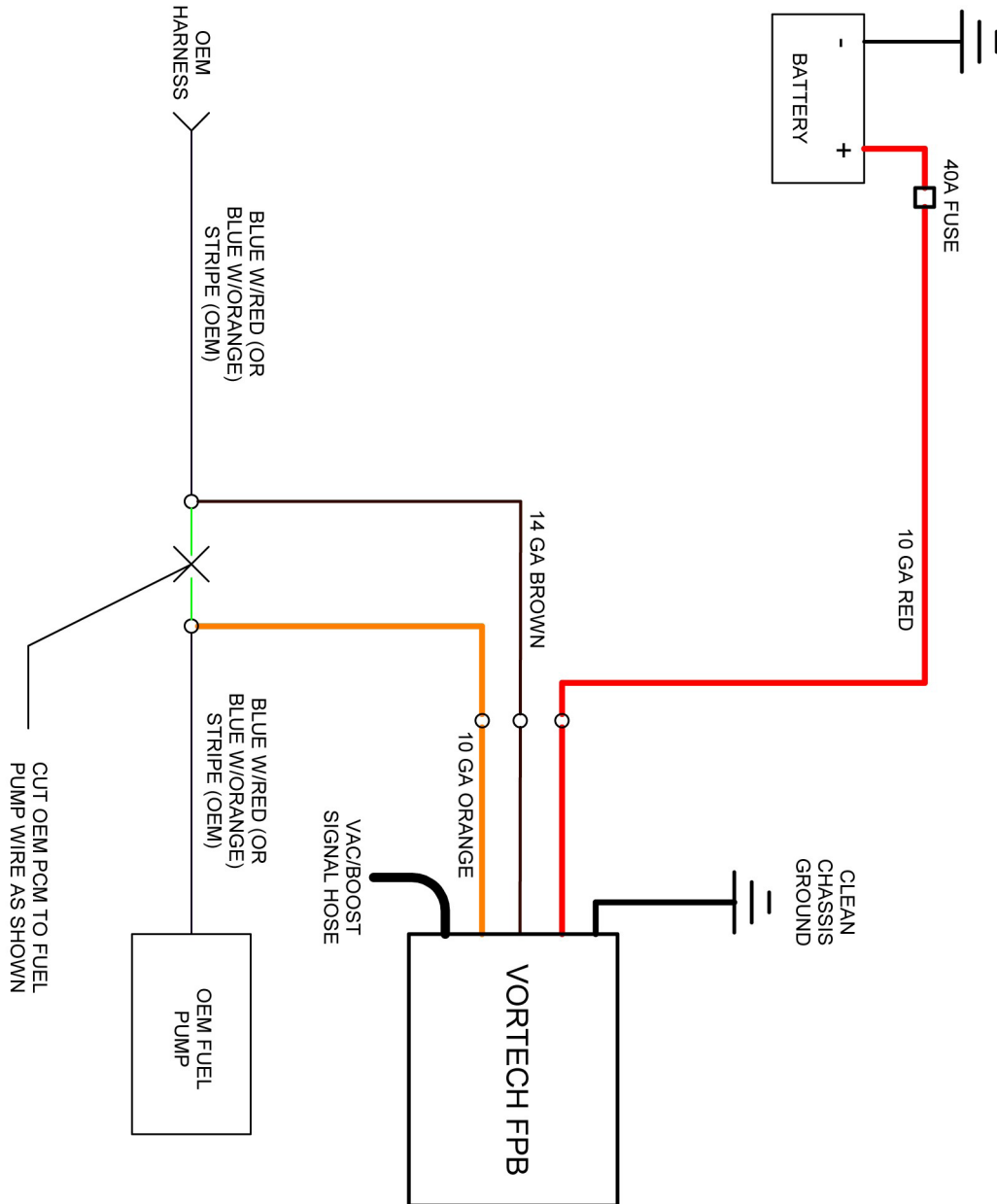

Fig. 11-g

11. FUEL PUMP VOLTAGE BOOSTER INSTALLATION con't

WIRING DIAGRAM

Fig. 11-h



12. REFLASH COMPUTER

IMPORTANT! To ensure trouble-free programming of your vehicle's computer:

- Make sure the vehicle's battery is sufficiently charged.
- Turn off all accessories and close doors to prevent unnecessary drain on the battery.
- Do not attempt to program your vehicle while a battery charger is connected.
- Improper battery voltage will result in failure of the programming process.
- Do not disconnect the cable or turn off the ignition during programming.

- Reconnect the battery.
- Locate the vehicles OBD2 connector located below the dash on the driver's side of the vehicle.
- Attach the OBD2 connector from the Flash tool that is provided in the kit to the vehicle's OBD2 port. Make sure this connector is seated all the way in the vehicle's OBD2 port. You do not want this connector coming out during programming or damage may occur to the vehicle's ECM.
- The Reflash tool should power up and display three parameters. (See Fig. 13-b)
 - Tune Vehicle
 - Scan Tool
 - Settings
- Select "Tune Vehicle" by pressing the icon.
- Read the disclaimer entirely, then select agree and press ENTER.
- At this point follow the instructions on the screen displayed on the reflash tool. If you have any questions, either refer to the manual that is provided with the reflash tool or contact our service department for further assistance.
- Turn the ignition on (*do not start the vehicle*). Set the parking brake and press the ENTER button to continue.

NOTE: Do not disturb the cable, or turn the ignition off during this time. If the programming is disrupted, the computer will not start or run your vehicle!

- SELECT TUNE will be displayed at the top of the screen. Select the appropriate tune for your vehicle. You will have a choice of two to choose from:
 - Vortech (used for installing kit)
 - Original Backup
- Continue to follow the screen and when finished, unplug the reflash tool from the vehicle's OBD2 port.



Fig. 13-a (inTUNE Programmer)

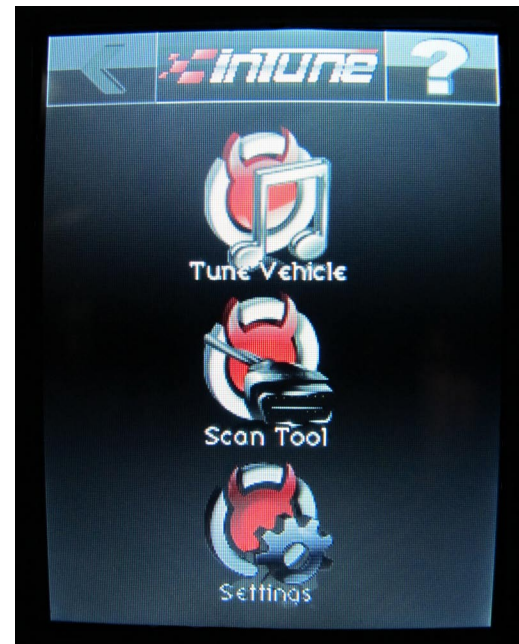

Fig. 13-b (inTUNE Touchscreen Display)

13. FINAL ASSEMBLY AND CHECKING

NOTE: THIS SUPERCHARGER HAS BEEN FACTORY PRE-FILLED WITH SPECIAL SYNTHETIC LUBRICANT. OIL DOES NOT NEED TO BE ADDED TO A BRAND NEW UNIT. HOWEVER THE FOLLOWING FLUID LEVEL CHECK SHOULD BE PERFORMED.

- A. Remove the factory installed flat head brass shipping plug (not the dipstick) from the top of the supercharger case.
- B. Replace the sealed shipping plug with the supplied "vented" plug. Do not operate the supercharger without it.
- C. Ensure that the .06" copper sealing washer is located on the dipstick base.
- D. Thread the clean dipstick into the supercharger until it seats.
- E. Once the dipstick has seated, remove the dipstick from the unit. Fluid should register in the crosshatched area on the dipstick.
- F. **DO NOT OVERFILL!!** Drain excess fluid from the unit if it is above the maximum level on the dipstick. Install and tighten the dipstick in the gearcase.
- G. If your vehicle has gone over 20,000 miles since its last spark plug change, it is a good idea to change the spark plugs now, before test-driving.
- H. Make sure that the vehicle is filled with 91 octane or higher fuel before commencing test drive.
- I. With key on, make sure charge air cooler water pump is operating and that water is flowing through the surge tank. Fill as necessary. If water is not flowing, remove the hose from the bottom of the surge tank and lower until water flows out of hose. This should prime the pump. Reconnect hose, verify water flow and top off surge tank. Do not run the water pump for extended periods (30 seconds or more) without water flow.
- J. Check all fittings, nuts, bolt and clamps for tightness.
- K. At this point it is OK to start the vehicle.

WARNING: DO NOT ATTEMPT TO OPERATE THE VEHICLE UNTIL ALL COMPONENTS ARE INSTALLED AND ALL OPERATIONS ARE COMPLETED INCLUDING FINAL CHECK. FAILURE TO DO SO MAY CAUSE PREMATURE FAILURE OF MAJOR COMPONENTS.

- L. With engine running, check power steering hose connections for leakage. Let engine run for two minutes. Turn steering wheel in both directions.



Fig. 13-a

13. FINAL ASSEMBLY AND CHECKING con't

Verify:

- Smooth power assist
 - Noiseless operation
 - Proper fluid level
 - No system leaks
 - No bubbles, foam or discoloration in fluid
- M. Verify that the gilmer belt is running smoothly. If wear is detected on the side of the belt, it is probably too tight. If it is vibrating excessively, tighten until there is minimal movement.
- N. Turn off vehicle and recheck all fluid levels and verify that no hoses, wires, etc. are near exhaust headers or moving parts and that there is no fluid leakage.
- O. Re-install the splash pan.
- P. Test drive vehicle by gradually working up to full throttle and paying close attention to any abnormal sounds or engine detonation.
- Q. Install the engine cover by trimming the driver side to clear the supercharger kit.
- R. Read the STREET SUPERCHARGER SYSTEM OWNER'S MANUAL AND RETURN THE WARRANTY REGISTRATION FORM within thirty (30) days of purchasing your supercharger system to qualify for the 3 year limited warranty.

WARNING: NEVER OPERATE YOUR ENGINE AT FULL THROTTLE WHEN THE ENGINE IS COLD. ALWAYS ALLOW PLENTY OF TIME FOR THE OIL TO REACH FULL OPERATING TEMPERATURE BEFORE RUNNING ABOVE 2,500 RPM. FULL SUPERCHARGER OPERATING TEMPERATURE IS GENERALLY ACHIEVED ONLY AFTER THE ENGINE WATER TEMPERATURE HAS BEEN AT THE NORMAL INDICATED OPERATING RANGE FOR TWO OR THREE MINUTES.

V3 supercharger long term maintenance and care:

- **CAUTION:** Use of any fluid other than the Vortech supplied synthetic lubricating fluid will void the warranty and may cause component failure.
Replacement Vortech SL lubricating fluid part numbers:
009035: Package of three 4 oz. bottles
 - Check the fluid level using the dipstick at least every 2,500 miles.
 - Initial supercharger fluid change must be performed at 2,500 miles. The supercharger fluid must then be changed at least every 7,500 miles.
1. Drain the fluid, re-fill the unit only with 4 oz. of Vortech supplied synthetic lubricating fluid.
 2. Confirm proper oil level using the dipstick. **DO NOT OVERFILL!!**



ENGINEERING, INC

1650 PACIFIC AVENUE • CHANNEL ISLANDS, CA 93033-9901 • (805) 247-0226
FAX (805) 247-0669 • www.vortechsuperchargers.com • M-F 7:00 AM - 3:30 PM PST